



www.retta.com.tr



ÜRÜN KATALOĞU 2021



PROFESYONEL
EL ALETLERİ



Değerli iş ortaklarımız;

Sizlerle beraber geçirmiş olduğumuz 32 yılın eseri olarak hazırlamış olduğumuz 2021 yılı ürün katalogu ve fiyat listemizi sizlere sunmaktan mutluluk duyuyoruz.

2020 Yılı; tüm dünya için zorlu bir yıl oldu, bu süreçte bizler RETTA ailesi olarak üretim yatırımlarımızla büyümeye devam ettik.

İstanbul Esenyurt merkez ve üretim tesisimize ek olarak, 2019 da yatırımlarına başladığımız, İzmit Dilovası sıcak dövme tesislerimizde, yüksek teknolojik yatırımlarımızı tamamladık.

Yeni bir yılda, yeni heyecanlarla olabildiğince rekabetçi bir yaklaşımla, Türk sanayisinin yanında olacağız.

Ürün yönetiminde her zaman olduğu gibi;

- **Rekabetçi** olmak
- **Estetik** olmak
- **Tasarımda özgünlük**
- **Tercih nedeni** olmak
- **Alışılmışın dışında** olmak

İlkelerimize bağlılığımızı sürdüreceğiz, Tıpkı 32 yıldır olduğu gibi.

Tüm bayilerimizin ve bayi temsilcilerimizin, RETTA ilkelerini kendi öz benliğiyle bütünleştirerek, oluşturdukları marka güveniyle tüm profesyonel kullanıcılara hizmet etmeleri de yüreğimizdeki vazgeçilmez ilkemizdir.

Her zaman daha iyisi olacağı inancı ile yakaladığı kaliteyi sürekli olarak ölçerek iyileştirmek şirketimizin birinci önceliğidir.

Bu vesile ile siz dostlarımıza sağlık ve huzur dolu yarınlar dileriz.

Saygılarımızla

RETTA PROFESYONEL EL ALETLERİ A.Ş.



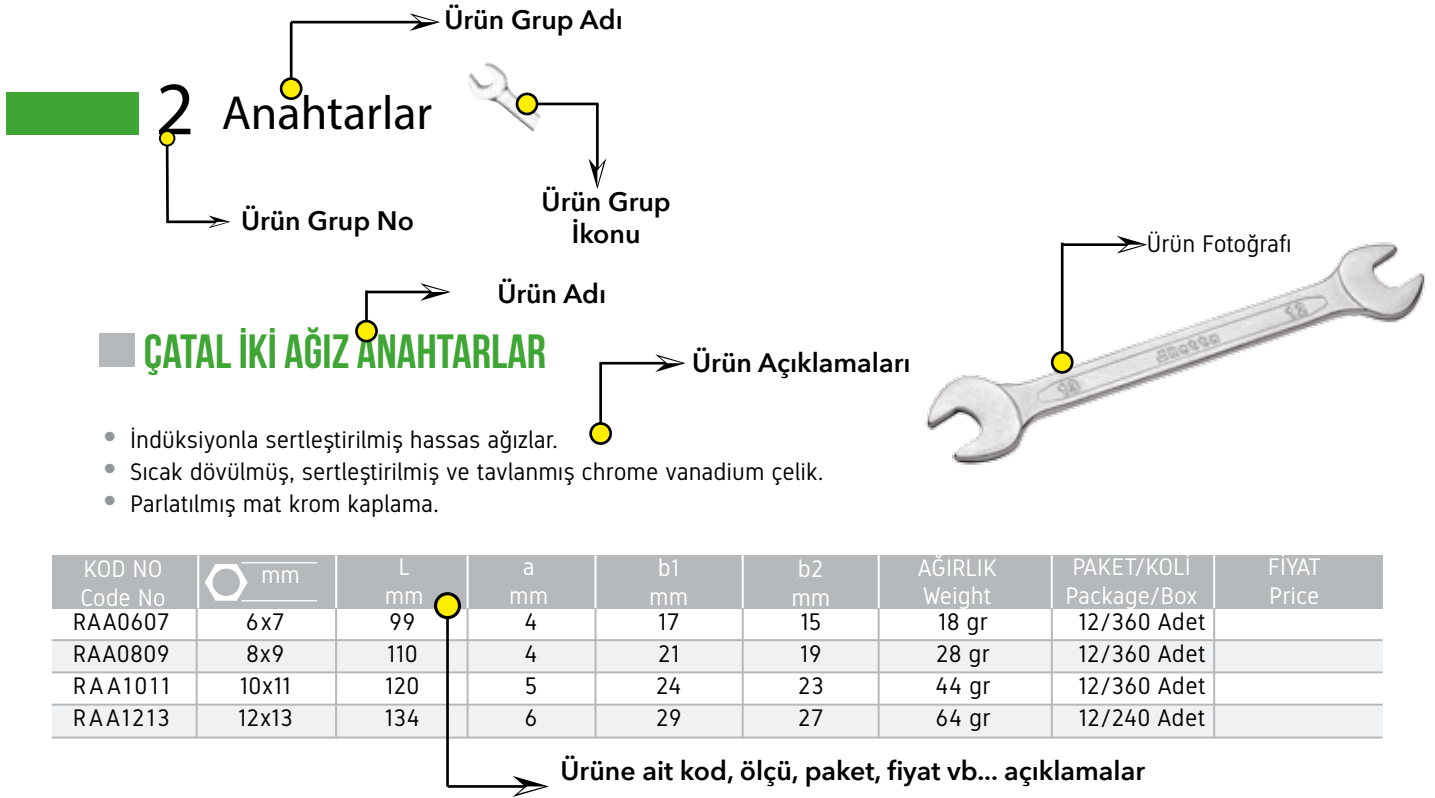

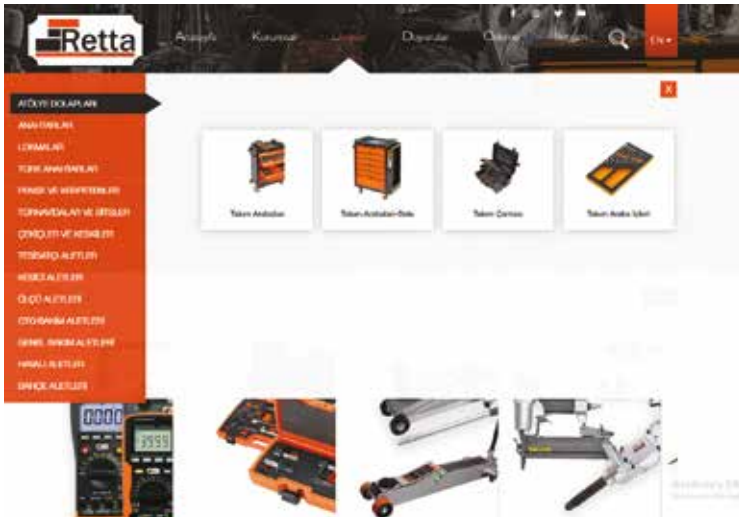

Online İletişim Noktamız
www.retta.com.tr

B2B Bayi Portalı
bayi.retta.com.tr

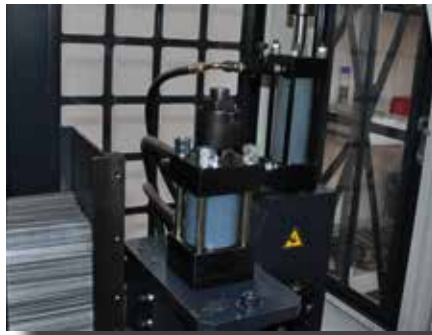





Ölçüler

 3/8" Kare Adaptör (Dişi)

 3/4" Kare Adaptör (Dişi)

 1/4" Kare Adaptör (Dişi)

 1/2" Kare Adaptör (Dişi)

 1" Kare Adaptör (Dişi)

 3/8" Kare Adaptör (Erkek)

 3/4" Kare Adaptör (Erkek)

 1/4" Kare Adaptör (Erkek)

 1/2" Kare Adaptör (Erkek)

 1" Kare Adaptör (Erkek)

 Kablo Kesme Çapı (mm)

 Boru Kesme Çapı (mm)

 Boru Kesme Çapı (Inç)

 Anahtar Ağızı Ölçüsü (mm)

 Anahtar Ağızı Ölçüsü (Inç)

 Tork (Nm)

 Tork (lbf.ft)

Profiller

 Düz Uç

 Yıldız Uç

 Pozidriv Uç

 Dış Torx

 İç Torx

 Delikli Torx

 12 Köşe Uç (Erkek) -XZN

 12 Köşe Uç (Dişi) -XZN

 Altı Köşe Uç (Erkek)

 Altı Köşe Uç (Dişi)

 Lokma Uç

 5 Köşe Torx

 Kare Uç (Erkek)

 Kare Uç (Dişi)

 Ribe Uç

 Torq-Set

 Tri-Wing

 Top Baş Allen

Diğerleri

 Kablo Sıyırma Ağızı

 Kesici Ağız

 Çene Şekli Düz

 Çene Şekli Yarı Yuvarlak

 Çene Şekli Yuvarlak

 İç Emniyet Segmanları

 Dış Emniyet Segmanları

 SDS Plus

 SDS Max

 Mıknatıs

 Zımpara Yörünge Çapı

 Max.

 Min.

 Ağırlık (kg)

 Testere Ağız Uzunluğu

 Kesici Bıçak Genişliği

 Benzinli Motor

 Dizel Motor

 Gazlı Motor

Sektörler



Otomotiv



Endüstri



İnşaat



Enerji



Gemi Sanayi



12-33

01

Atölye Dolapları ve EVA Modüller

Takım Arabaları, Çalışma Tezgahları, Takım Çantaları, EVA Takım Modülleri



34-54

02

Anahtarlar

Çatal İki Ağız Anahtarlar, Cırcır Anahtarlar, Allen Anahtarlar, Torx Anahtarlar, Kurbağacık Anahtarlar



55-91

03

Lokmalar

Lokma Anahtarlar, Cırcır Kolları, Lokma Takımları, Lokmalı Bits Setler, Havalı Lokmalar



92-95

04

Tork Anahtarlar

Tork Anahtarlar, Tork Arttırıcı Set, Tork Açı Ölçerler



96-109

05

Penseler

Penseler, Yankeskiler, Mini Penseler, Kerpetenler, Ayarlı Penseler, Telefoncu Penseleri



110-130

06

Tornavidalar

Asetat Tornavidalar, RX Tornavidalar, Bits Uçlar, Kontrol Kalemleri, Mikro Tornavidalar



131-142

07

Bits Uçlar ve Setleri

Bits Uçlar, Bits Setler, Bits Adaptörler



143-154

08

Çekiç, Keski ve SDS Uçlar

Çekiçler, Pim Zimbalar, Keski, SDS Uçlar, Mandrenler, Zimbalar ve Çiviler



155-157

09

Tesisatçı Aletleri

Boru Anahtarları, Boru Makasları, Boru Kesiciler



158-166

10

Kesici Aletler-Zimba ve Çiviler

Kaportacı Makasları, Maket Bıçakları, Bi-Metal Pançlar, Daire Testereler



167-170

11

Ölçü Aletleri

Metreler, Kumpaslar, Gönyeler ve Su Terazileri



171-189

12

Oto Bakım Aletleri

Tork Anahtarlar, Kelepçe Penseleri, Çektirmeler, Filtre Anahtarları, Sente Aparatları



190-204

13

Genel Bakım Aletleri

Krikolar, Gres Pompası, Lastik Şişirme Tabancaları, Tel Fırçaları



205-217

14

Havalı Aletler

Havalı Somun Sıkma, Havalı Cırcırlar, Zimba Makinaları, Çivi Makinaları



218-219

15

Bahçe Aletleri

Testereler, Bağ Makasları

KOMBİNE ANAHTARLAR

- Hassas broş değerinde üretim.
- Tolerans sapma engelleyici Özel Alman Teknolojisi

- Güçlü şekilde civata kavrama özelliği

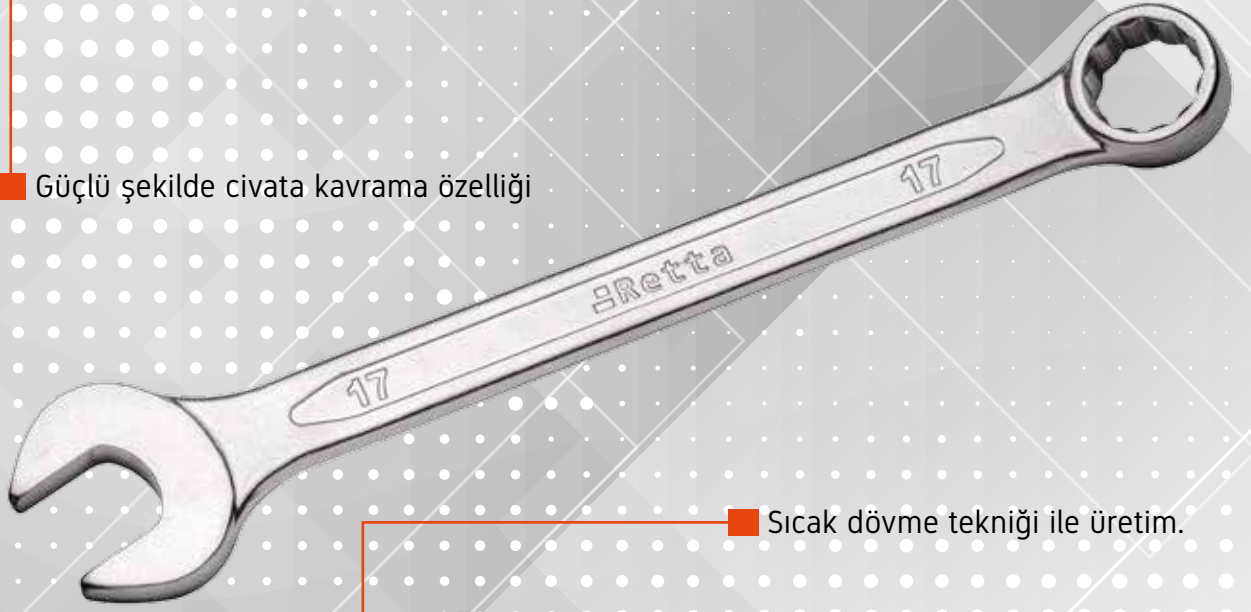

- Sıcak dövme tekniği ile üretim.

- Ultrasonik dedektör ile kontrol

- Yüksek vasıflı CHORME VANADIUM çeliği

ÇATAL İKİ AĞIZ ANAHTARLAR



- DIN ve ISO üzerinde Tork değerleri

YENİ YERLİ ÜRETİM

Retta
PROFLINE TOOLS

ÇEKİÇ

AĞAÇ SAPLI TESVİYECİ ÇEKİCİ



Dövme çelik

Özel sertleştirilmiş vurma yüzeyi

Özel kızılğaç sap

Çizilmez elektrostatik toz boya

KAYIŞLI FİLTRE - BORU ANAHTARI
RKB0012

Yüksek vasıflı
CHORME VANADIUM çeliği

Sıcak dövme tekniği ile
üretim



KAYIŞLI FİLTRE - BORU ANAHTARI
RKB0009

Özel çekme bant
kayışı

Yüksek Kavrama ve
Tutuş özelliği



YENİ YERLİ ÜRETİM



FİLTRE ANAHTARLARI

ZİNCİRLİ FİLTRE ANAHTARI

Yüksek vasıflı
CHORME VANADIUM çeliği

Çekme ve kavrama
mukavemeti yüksek
dişli zinciri



Yüksek vasıflı
CHORME VANADIUM çeliği

PVC SAPLI FİLTRE ANAHTARI

60-90 mm arasında
yüksek mukavemetli kavrama

Özel daldırma
PVC sap





Retta
PROFI LINE TOOLS

Retta Profesyonel El Aletleri olarak geliştirmiş olduğumuz atölye dolapları ve takım çantaları ürün programımız, içerdiği EVA modülleri ile fabrika ve atölyelerde daha modern bir görüntü oluşturmak ve envanter kontrolünü hızlı ve kolay bir şekilde gerçekleştirmeniz için tasarlanmıştır.

- ◆ Küçük parçalar için 12 gözden oluşan ABS'den mamül çalışma tablası
- ◆ Kolay itme ve çekmeye yarayan tutma kolu
- ◆ Çekmeceler teleskopik ray düzeneği ile tamamen çekilebilir, çıkarılabilir.
- ◆ Merkezi kilit sistemi, tek elle yapılan kullanımlarda bile istenmeyen açılmaları önler.
- ◆ Alt çekmece havaleli ve ağır yük çekmecesi olarak tasarlanmıştır.
- ◆ Darbeye dayanıklı yüksek kaliteli sac çizilmez elektrostatik fırın boya ile kaplanmıştır.



Merkezi
Kilit Sistemi



Ergonomik
Tutma Kolu



Teleskopik Ray Sistemi
Akıllı kilit sistemi



2 Sabit, 2 Hareketli
Kauçuk Tekerlekler
(1 fren sistemli tekerlek)

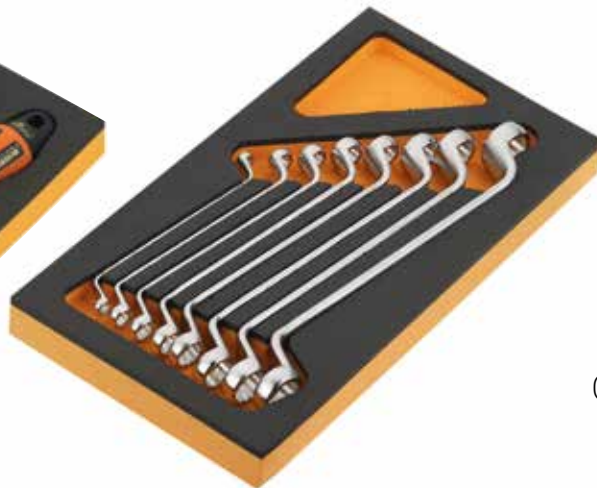

ATÖLYE DOLAPLARI

“Aradığınız herşey yerli yerinde”

Ürünlerinizin farkedilebilirliğini artırmak ve düzenli bir çalışma ortamı sağlamak için tasarlanmıştır. Özel EVA yapısı ile darbelere, kimyasallara dayanıklı ve temizliği kolay modüller.





RAFLI TAŞIMA ARABASI - 1010

- Darbeye dayanıklı yüksek kalite sac
- Çizilmez elektrostatik fırın boya
- Mukavemetli orta raf



MONOLINE
THE PROFESSIONAL GARAGE TOOLS

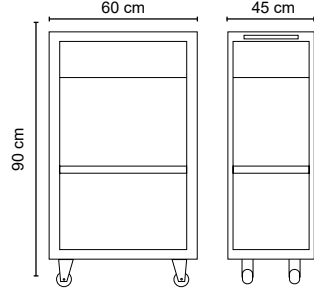

h	Max
3 cm	35 kg

KOD NO Code No	YÜKSEKLİK Height	GENİŞLİK Width	DERİNLİK Depth	FİYAT Price
RTA1010	90 cm	60 cm	45 cm	

RAFLI TAŞIMA ARABASI - 1020

- Darbeye dayanıklı yüksek kalite sac
- Çizilmez elektrostatik fırın boya
- Mukavemetli orta raf



MONOLINE
THE PROFESSIONAL GARAGE TOOLS

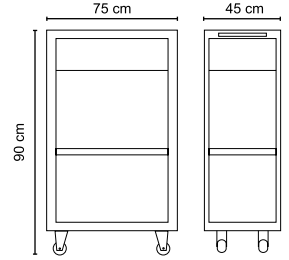

h	Max
3 cm	35 kg

KOD NO Code No	YÜKSEKLİK Height	GENİŞLİK Width	DERİNLİK Depth	FİYAT Price
RTA1020	90 cm	75 cm	45 cm	



MONOLINE
THE PROFESSIONAL GARAGE TOOLS

RAFLI TAŞIMA ARABASI - 1030 - ÇEKMECELİ

- EVA modülleriyle uyumlu %100 açılabilen teleskopik raylı çekmece
- Darbeye dayanıklı yüksek kalite sac
- Çizilmez elektrostatik fırın boya



h	Max
10 cm	35 kg

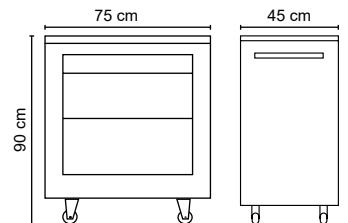

KOD NO Code No	YÜKSEKLİK Height	GENİŞLİK Width	DERİNLİK Depth	FİYAT Price
RTA1030	90 cm	75 cm	45 cm	

PROLINE

THE PROFESSIONAL GARAGE TOOLS



USTA TABURESİ - ÇEKMECELİ

- Darbeye dayanıklı yüksek kalite sac
- Çizilmez elektrostatik fırın boya
- Deri kaplama 90 DN sünger ile konforlu oturuş
- Üç adet sprey koyma gözü



h		Max	kg Max
13 cm		15 kg	150 kg

KOD NO Code No	YÜKSEKLİK Height	GENİŞLİK Width	DERİNLİK Depth	FİYAT Price
RTA0900	50 cm	40 cm	45 cm	

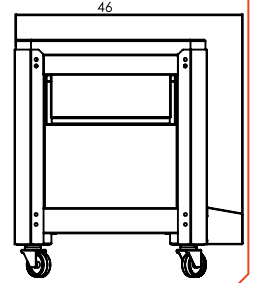
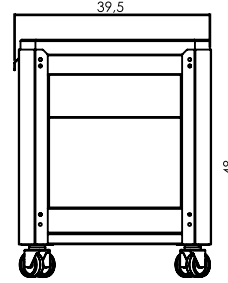

MONOLINE

THE PROFESSIONAL GARAGE TOOLS

RAFLI TAŞIMA ARABASI - 3 ÇEKMECELİ

- EVA modülleriyle uyumlu %100 açılabilen teleskopik raylı çekmece
- Darbeye dayanıklı yüksek kalite sac
- Çizilmez elektrostatik fırın boya



h		Max
3x10 cm		35 kg

KOD NO Code No	YÜKSEKLİK Height	GENİŞLİK Width	DERİNLİK Depth	FİYAT Price
RTA1040	90 cm	80 cm	45 cm	

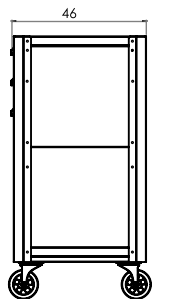
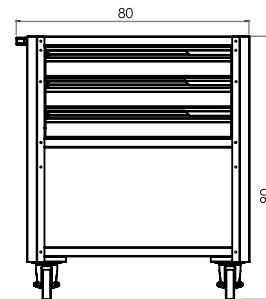



RAFLI TAKIM ARABASI - 4 ÇEKMECE

- EVA modülleriyle uyumlu %100 açılabilen teleskopik raylı çekmeceler
- İstem dışı açılımları engelleyici "Akıllı Kilit Sistemi"
- Darbeye dayanıklı yüksek kalite sac
- Çizilmez elektrostatik fırın boya

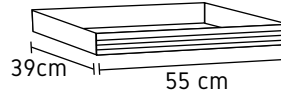

h		Max
4x13,5 cm		35 kg

KOD NO Code No	YÜKSEKLİK Height	GENİŞLİK Width	DERİNLİK Depth	FİYAT Price
RTA1060	90 cm	80 cm	45 cm	

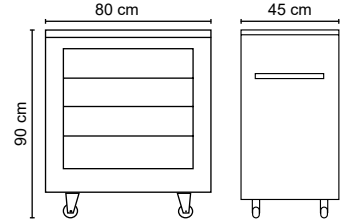

TAKIM ARABASI - 4 ÇEKMECE

- EVA modülleriyle uyumlu %100 açılabilen teleskopik raylı çekmeceler
- İstem dışı açılımları engelleyici "Akıllı Kilit Sistemi"
- Darbeye dayanıklı yüksek kalite sac
- Çizilmez elektrostatik fırın boya
- 7 gözlü üst bölüm

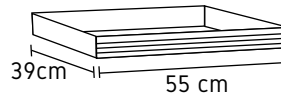

h		Max
3x13,5 cm		35 kg
20 cm		35 kg

KOD NO Code No	YÜKSEKLİK Height	GENİŞLİK Width	DERİNLİK Depth	AĞIRLIK Weight	FİYAT Price
RTY4001	90 cm	82 cm	45 cm	45,70 kg	

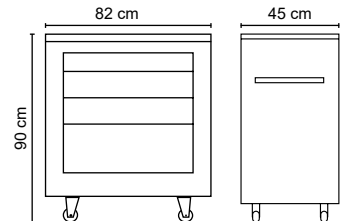

MONOLINE

THE PROFESSIONAL GARAGE TOOLS

TAKIM ARABASI - 5 ÇEKMECE

- EVA modülleriyle uyumlu %100 açılabilen teleskopik raylı çekmeceler
- İstem dışı açılımları engelleyici "Akıllı Kilit Sistemi"
- Darbeye dayanıklı yüksek kalite sac
- Çizilmez elektrostatik fırın boya
- 7 gözlü üst bölüm

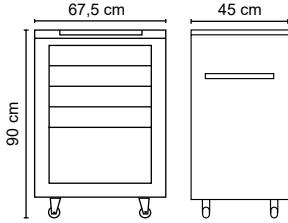

h	Max
4x 10 cm	35 kg
20 cm	35 kg

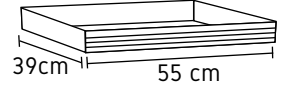

KOD NO Code No	YÜKSEKLİK Height	GENİŞLİK Width	DERİNLİK Depth	AĞIRLIK Weight	FİYAT Price
RTA5001	90 cm	67,5 cm	45 cm	48,50 kg	

PROLINE

THE PROFESSIONAL GARAGE TOOLS

TAKIM ARABASI - 5 ÇEKMECE

- EVA modülleriyle uyumlu %100 açılabilen teleskopik raylı çekmeceler
- İstem dışı açılımları engelleyici "Akıllı Kilit Sistemi"
- Darbeye dayanıklı yüksek kalite sac
- Çizilmez elektrostatik fırın boya
- 7 gözlü üst bölüm

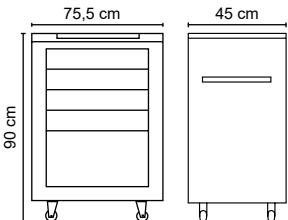

h	Max
4x 10 cm	35 kg
20 cm	35 kg



KOD NO Code No	YÜKSEKLİK Height	GENİŞLİK Width	DERİNLİK Depth	AĞIRLIK Weight	FİYAT Price
RTY5001	90 cm	77,5 cm	45 cm	56,24 kg	



TAKIM ARABASI - 6 ÇEKMECE

- EVA modülleriyle uyumlu %100 açılabilen teleskopik raylı çekmeceler
- İstem dışı açılımları engelleyici "Akıllı Kilit Sistemi"
- Darbeye dayanıklı yüksek kalite sac
- Çizilmez elektrostatik fırın boya
- 7 gözlü üst bölüm

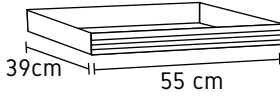

h	Max
5x 10 cm	35 kg
20 cm	35 kg

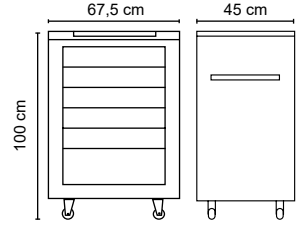

KOD NO Code No	YÜKSEKLİK Height	GENİŞLİK Width	DERİNLİK Depth	AĞIRLIK Weight	FİYAT Price
RTA6001	100 cm	67,5 cm	45 cm	55,76 kg	



TAKIM ARABASI - 6 ÇEKMECE

- EVA modülleriyle uyumlu %100 açılabilen teleskopik raylı çekmeceler
- İstem dışı açılımları engelleyici "Akıllı Kilit Sistemi"
- Darbeye dayanıklı yüksek kalite sac
- Çizilmez elektrostatik fırın boya
- 7 gözlü üst bölüm

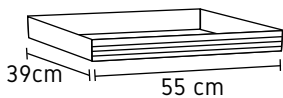

h	Max
5x 10 cm	35 kg
20 cm	35 kg

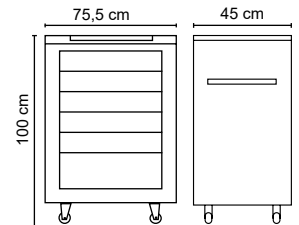

KOD NO Code No	YÜKSEKLİK Height	GENİŞLİK Width	DERİNLİK Depth	AĞIRLIK Weight	FİYAT Price
RTY6001	100 cm	75,5 cm	45 cm	60,70 kg	

MONOLINE

THE PROFESSIONAL GARAGE TOOLS

TAKIM ARABASI - 7 ÇEKMECE

- EVA modülleriyle uyumlu %100 açılabilen teleskopik raylı çekmeceler
- İstem dışı açılımları engelleyici "Akıllı Kilit Sistemi"
- Darbeye dayanıklı yüksek kalite sac
- Çizilmez elektrostatik fırın boya
- 7 gözlü üst bölüm

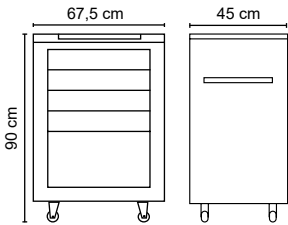

h		Max
6x	8,2 cm	35 kg
	117 cm	35 kg

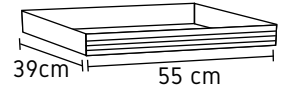

KOD NO Code No	YÜKSEKLİK Height	GENİŞLİK Width	DERİNLİK Depth	AĞIRLIK Weight	FİYAT Price
RTA7001	90 cm	67,5 cm	45 cm	48,50 kg	

PROLINE

THE PROFESSIONAL GARAGE TOOLS

TAKIM ARABASI - 7 ÇEKMECE

- EVA modülleriyle uyumlu %100 açılabilen teleskopik raylı çekmeceler
- İstem dışı açılımları engelleyici "Akıllı Kilit Sistemi"
- Darbeye dayanıklı yüksek kalite sac
- Çizilmez elektrostatik fırın boya
- 7 gözlü üst bölüm

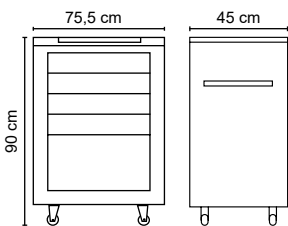

h		Max
6x	8,2 cm	35 kg
	117 cm	35 kg



KOD NO Code No	YÜKSEKLİK Height	GENİŞLİK Width	DERİNLİK Depth	AĞIRLIK Weight	FİYAT Price
RTY7001	90 cm	77,5 cm	45 cm	56,24 kg	



TAKIM ARABASI - 8 ÇEKMECE

- EVA modülleriyle uyumlu %100 açılabilen teleskopik raylı çekmeceler
- İstem dışı açılımları engelleyici "Akıllı Kilit Sistemi"
- Darbeye dayanıklı yüksek kalite sac
- Çizilmez elektrostatik fırın boya
- 7 gözlü üst bölüm

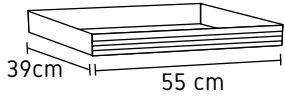

h		Max
8x	8,2 cm	35 kg

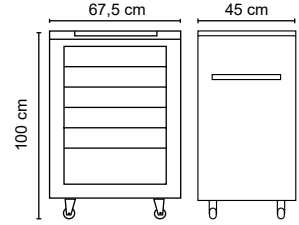

KOD NO Code No	YÜKSEKLİK Height	GENİŞLİK Width	DERİNLİK Depth	AĞIRLIK Weight	FİYAT Price
RTA8001	100 cm	67,5 cm	45 cm	55,76 kg	



TAKIM ARABASI - 8 ÇEKMECE

- EVA modülleriyle uyumlu %100 açılabilen teleskopik raylı çekmeceler
- İstem dışı açılımları engelleyici "Akıllı Kilit Sistemi"
- Darbeye dayanıklı yüksek kalite sac
- Çizilmez elektrostatik fırın boya
- 7 gözlü üst bölüm

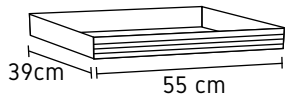

h		Max
8x	8,2 cm	35 kg

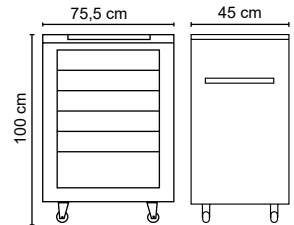

KOD NO Code No	YÜKSEKLİK Height	GENİŞLİK Width	DERİNLİK Depth	AĞIRLIK Weight	FİYAT Price
RTY8001	100 cm	75,5 cm	45 cm	60,70 kg	

MONOLINE

THE PROFESSIONAL GARAGE TOOLS

TAKIM ARABASI DOLAPLI - 3050

5 Çekmece + Dolap

- EVA modülleriyle uyumlu %100 açılabilen teleskopik raylı çekmeceler
- Mandalsız rulmanlı çekmeceler
- İstem dışı açılımları engelleyici "Akıllı Kilit Sistemi"
- Darbeye dayanıklı yüksek kalite sac
- Çizilmez elektrostatik fırın boya
- Kullanım kolaylığı sağlayan dayanıklı üst tabla
- İki bölmeli kapaklı, kilitli dolap

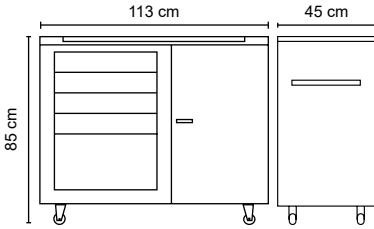

h	Max
4x 10 cm	35 kg
20 cm	35 kg



KOD NO Code No	YÜKSEKLİK Height	GENİŞLİK Width	DERİNLİK Depth	AĞIRLIK Weight	FİYAT Price
RTA3050	85 cm	113 cm	45 cm	66 kg	

MONOLINE

THE PROFESSIONAL GARAGE TOOLS

TAKIM ARABASI RAFLI - 3060

5 Çekmece + Yangöz

- EVA modülleriyle uyumlu %100 açılabilen teleskopik raylı çekmeceler
- İstem dışı açılımları engelleyici "Akıllı Kilit Sistemi"
- Darbeye dayanıklı yüksek kalite sac
- Çizilmez elektrostatik fırın boya
- Kullanım kolaylığı sağlayan dayanıklı üst tabla
- İki bölmeli raf

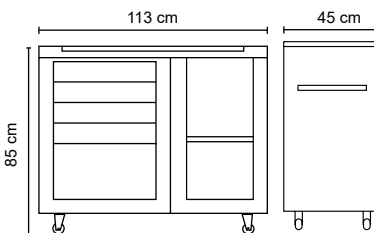

h	Max
4x 10 cm	35 kg
20 cm	35 kg

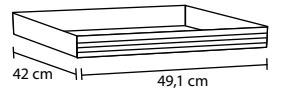

KOD NO Code No	YÜKSEKLİK Height	GENİŞLİK Width	DERİNLİK Depth	AĞIRLIK Weight	FİYAT Price
RTA3060	85 cm	113 cm	45 cm	58 kg	



TAKIM ARABASI DOLAPLI - 3070

5 Çekmece + Dolap

- EVA modülleriyle uyumlu %100 açılabilen teleskopik raylı çekmeceler
- İstem dışı açılımları engelleyici "Akıllı Kilit Sistemi"
- Darbeye dayanıklı yüksek kalite sac
- Çizilmez elektrostatik fırın boya
- Kullanım kolaylığı sağlayan dayanıklı üst tabla
- Dolap içi iki adet raylı çekmece

h	Max
4x 10 cm	35 kg
20 cm	35 kg

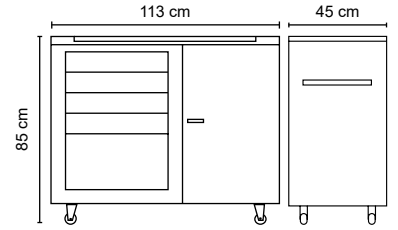
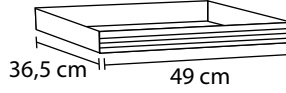

KOD NO Code No	YÜKSEKLİK Height	GENİŞLİK Width	DERİNLİK Depth	AĞIRLIK Weight	FİYAT Price
RTA3070	85 cm	113 cm	45 cm	66 kg	



MONOLINE

THE PROFESSIONAL GARAGE TOOLS

PROMAX TAKIM ARABASI DOLAPLI

6 Çekmece + Dolap

- EVA modülleriyle uyumlu %100 açılabilen teleskopik raylı çekmeceler
- İstem dışı açılımları engelleyici "Akıllı Kilit Sistemi"
- Darbeye dayanıklı yüksek kalite sac
- Çizilmez elektrostatik fırın boya
- Kullanım kolaylığı sağlayan dayanıklı üst tabla



h	Max
4x 10 cm	35 kg
1x 20 cm	35 kg
1x 10 cm	35 kg

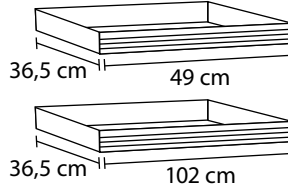

36,5 cm 49 cm
36,5 cm 102 cm Üst Çekmece

KOD NO Code No	YÜKSEKLİK Height	GENİŞLİK Width	DERİNLİK Depth	FIYAT Price
RTA3080	100 cm	115 cm	45 cm	

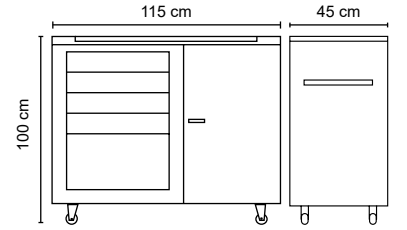

MONOLINE

THE PROFESSIONAL GARAGE TOOLS

PROMAX TAKIM ARABASI ÇEKMECELİ

11 Çekmece

- İstem dışı açılımları engelleyici "Akıllı Kilit Sistemi"
- Darbeye dayanıklı yüksek kalite sac
- Çizilmez elektrostatik fırın boya
- Kullanım kolaylığı sağlayan dayanıklı üst tabla



h	Max
6x 10 cm	35 kg
3x 20 cm	35 kg
1x 10 cm	35 kg

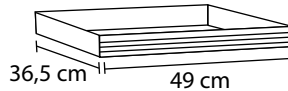

36,5 cm 49 cm

KOD NO Code No	YÜKSEKLİK Height	GENİŞLİK Width	DERİNLİK Depth	FIYAT Price
RTA3090	100 cm	115 cm	45 cm	

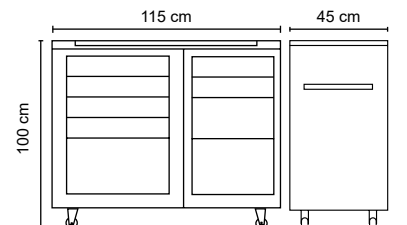



MONOLINE
THE PROFESSIONAL GARAGE TOOLS



ÇALIŞMA TEZGAHI - ÇEKMECELİ 3 Çekmece

- Yüksek kaliteli çelikten sağlam gövde
- İstem dışı açılımları engelleyici "Akıllı Kilit Sistemi"
- Darbeye dayanıklı yüksek kalite sac
- Çizilmez elektrostatik fırın boya
- Kullanım kolaylığı sağlayan dayanıklı üst tabla
- Zemin yapısına göre ayarlanabilir özel ayaklar
- Çalışma tezgahı üzerinde, 1 mm galvaniz kaplama sac

h		Max
3x	10 cm	35 kg

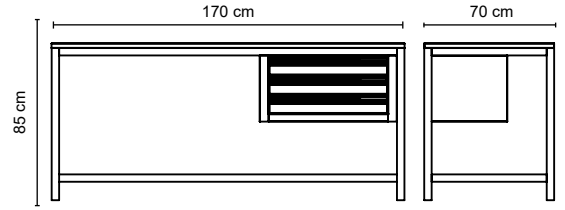
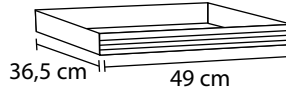

KOD NO Code No	YÜKSEKLİK Height	GENİŞLİK Width	DERİNLİK Depth	FİYAT Price
RTA9001	85 cm	170 cm	70 cm	



MONOLINE
THE PROFESSIONAL GARAGE TOOLS

PANOLU ÇALIŞMA TEZGAHI - ÇEKMECELİ 1 Ürün Asma Panosu + 3 Çekmece

- Yüksek kaliteli çelikten sağlam gövde - Aydınlatma ve elektrik tesisatı
- İstem dışı açılımları engelleyici "Akıllı Kilit Sistemi"
- Darbeye dayanıklı yüksek kalite sac
- Çizilmez elektrostatik fırın boya
- Zemin yapısına göre ayarlanabilir özel ayaklar
- Çalışma tezgahı üzerinde, 1 mm galvaniz kaplama sac

	Max
10 cm	35 kg

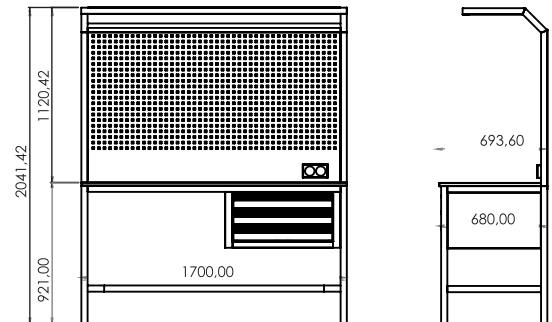
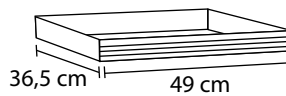

KOD NO Code No	YÜKSEKLİK Height	GENİŞLİK Width	DERİNLİK Depth	FİYAT Price
RTA9101	205 cm	170 cm	70 cm	

MONOLINE

THE PROFESSIONAL GARAGE TOOLS

PANOLU ÇALIŞMA TEZGAHI ÇEKMECE + DOLAPLI

1 Takım Asma Panosu + 5 Çekmece + Dolap

- Yüksek kaliteli çelikten sağlam gövde - Aydınlatma ve elektrik tesisatı
- İstem dışı açılımları engelleyici "Akıllı Kilit Sistemi"
- Darbeye dayanıklı yüksek kalite sac
- Çizilmez elektrostatik fırın boya
- Zemin yapısına göre ayarlanabilir özel ayaklar
- Çalışma tezgahı üzerinde, 1 mm galvaniz kaplama sac

h	Max
4x 10 cm	35 kg
20 cm	35 kg



KOD NO Code No	YÜKSEKLİK Height	GENİŞLİK Width	DERİNLİK Depth	FIYAT Price
RTA9201	201 cm	137 cm	75 cm	

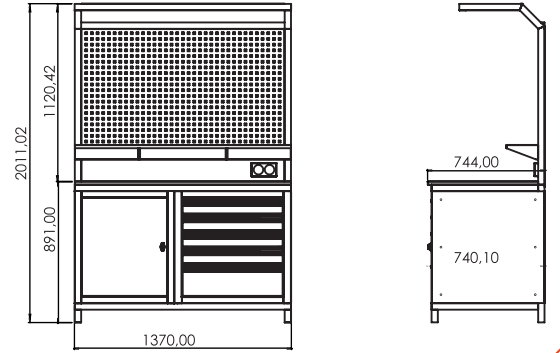

MONOLINE

THE PROFESSIONAL GARAGE TOOLS

PANOLU ÇALIŞMA TEZGAHI ÇEKMECE + 2 DOLAPLI

1 Takım Asma Panosu + 5 Çekmece + 2 Dolap

- Yüksek kaliteli çelikten sağlam gövde - Aydınlatma ve elektrik tesisatı
- İstem dışı açılımları engelleyici "Akıllı Kilit Sistemi"
- Darbeye dayanıklı yüksek kalite sac
- Çizilmez elektrostatik fırın boya
- Zemin yapısına göre ayarlanabilir özel ayaklar
- Çalışma tezgahı üzerinde, 1 mm galvaniz kaplama sac

h	Max
10 cm	35 kg
20 cm	35 kg

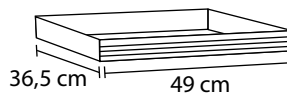

KOD NO Code No	YÜKSEKLİK Height	GENİŞLİK Width	DERİNLİK Depth	FIYAT Price
RTA9301	200 cm	200 cm	75 cm	

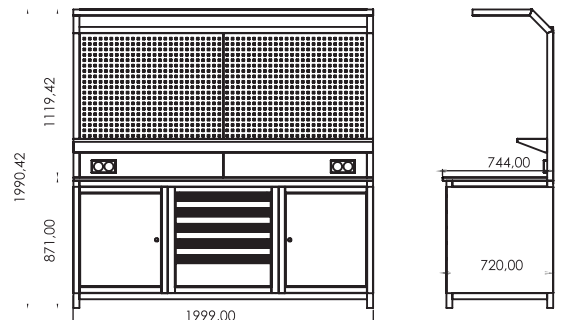



TAMİR KİTİ - 181PCS

MONOLINE
 THE PROFESSIONAL GARAGE TOOLS RTA5141

PROLINE
 THE PROFESSIONAL GARAGE TOOLS RTY5141

KOD NO Code No	YÜKSEKLİK Height	GENİŞLİK Width	DERİNLİK Depth	AĞIRLIK Weight	FİYAT Price
RTA5141	90 cm	67,5 cm	45 cm	65 kg	
RTY5141	90 cm	75,5 cm	45 cm	67 kg	

1. ÇEKMECE

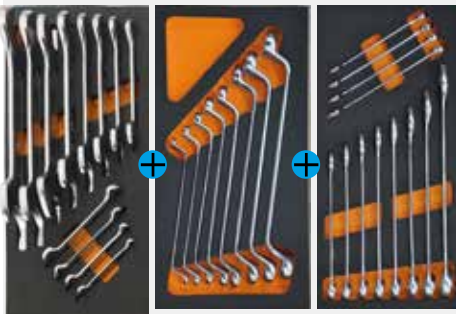

1. ÇEKMECE
- RES0102 - Çatal iki Ağız Anahtar Seti 12pcs
 - RES0111 - Yıldız İki Ağız Anahtar Seti 8pcs
 - RES0121 - Kombine Anahtar Seti 12pcs

2. ÇEKMECE



2. ÇEKMECE
- RES0201 - 1/4" Lokma Seti 54pcs
 - RES0221 - 1/2" Lokma Seti 23pcs
 - RES0291 - 10mm Torx-Allen Bits Seti 43pcs

3. ÇEKMECE



3. ÇEKMECE
- RES0301 - Pense Seti - Yankeski 3pcs
 - RES0321 - Ayarlı Pense - Kurbağacık Seti 4pcs
 - RES0341 - Maxi Grip Segman Pense Seti 4pcs

4. ÇEKMECE



4. ÇEKMECE
- RES0491 - RX Tornavida Seti 6pcs
 - RES0431 - RX Lokma Tornavida Seti 6pcs
 - RES0451 - RX Torx Tornavida Seti 6pcs

TAMIR KİTİ - 205PCS

MONOLINE RTA6205
THE PROFESSIONAL GARAGE TOOLS



PROLINE RTY6205
THE PROFESSIONAL GARAGE TOOLS



KOD NO Code No	YÜKSEKLİK Height	GENİŞLİK Width	DERİNLİK Depth	AĞIRLIK Weight	FİYAT Price
RTA6205	100 cm	65 cm	45 cm	75kg	
RTY6205	100 cm	74 cm	45 cm	77kg	

1. ÇEKMECE

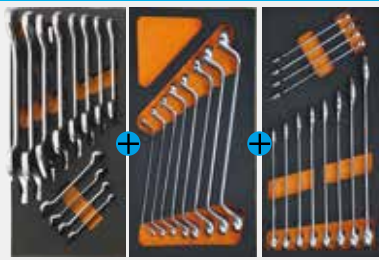

1. ÇEKMECE
- RES0102 - Çatal iki Ağız Anahtar Seti 12pcs
 - RES0111 - Yıldız İki Ağız Anahtar Seti 8pcs
 - RES0121 - Kombine Anahtar Seti 12pcs

2. ÇEKMECE



2. ÇEKMECE
- RES0201 - 1/4" Lokma Seti 54pcs
 - RES0221 - 1/2" Lokma Seti 23pcs
 - RES0291 - 10mm Torx-Allen Bits Seti 43pcs

3. ÇEKMECE



3. ÇEKMECE
- RES0301 - Pense Seti - Yankeski 3pcs
 - RES0321 - Çekiç, Keski, Ayarlı Pense Seti 4pcs
 - RES0341 - Segman Pensi, Miknats, Okont. Kalemi 4pcs

4. ÇEKMECE



4. ÇEKMECE
- RES0491 - RX Tornavida Seti 6pcs
 - RES0431 - RX Lokma ve Topaç Tornavida Seti 6pcs
 - RES0451 - RX Torx Tornavida Seti 6pcs

5. ÇEKMECE



5. ÇEKMECE
- RES0502 - T Saplı Allen Seti 6pcs
 - RES0261 - 1/2" İç & Dış Torx Lokma Seti 14pcs
 - RES0801 - Filtre Anahtar - Buji Seti 4pcs



YENİ MODÜLER EVA SETLERİ

FİLTRE ANAHTAR VE BUJİ LOKMA SETİ - 4PCS



İÇERİK: FİLTRE PENSESİ, KAYIŞLI FİLTRE ANAHTARI,
16-21 BUJİ LOKMALARI

KOD NO Code No	AĞIRLIK Weight	PAKET/KOLİ Package/Box	FİYAT Price
RES0801	760 gr	1 / 5 adet	

ÇEKİÇ, KESKİ, AYARLI PENSE SETİ - 4PCS



İÇERİK: UNİVERSAL AYARLI PENSE, FORT PENSE, ÇEKİÇ, KESKİ

KOD NO Code No	AĞIRLIK Weight	PAKET/KOLİ Package/Box	FİYAT Price
RES0321	760 gr	1 / 5 adet	

SEKMAN PENSESİ, FLEX MIKNATIS OTO KONTROL KALEMİ SETİ - 4PCS



İÇERİK: SEKMAN PENSESİ, İÇ DİŞ DÜZ FLEX MIKNATIS OTO
KONTROL KALEMİ

KOD NO Code No	AĞIRLIK Weight	PAKET/KOLİ Package/Box	FİYAT Price
RES0341	760 gr	1 / 5 adet	

LOKMA VE TOPAÇ TORNAVİDA SETİ - 6PCS



İÇERİK: 7, 8, 10, 13 LOKMA TORNAVİDA - 6X45, PH2X45 TOPAÇ
TORNAVİDA

KOD NO Code No	AĞIRLIK Weight	PAKET/KOLİ Package/Box	FİYAT Price
RES0431	760 gr	1 / 5 adet	



ÇATAL İKİ AĞIZ ANAHTAR SETİ - 8PCS

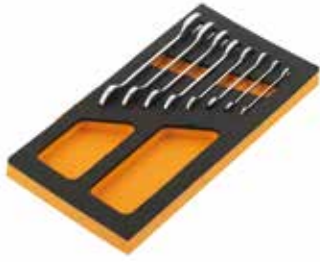

Made in
Turkey

İÇERİK: 6x7, 8x9, 10x11, 12x13, 14x15, 16x17, 18x19, 20x22 mm

KOD NO Code No	AĞIRLIK Weight	PAKET/KOLI Package/Box	FIYAT Price
RES0101	760 gr	1 / 5 adet	

ÇATAL İKİ AĞIZ ANAHTAR SETİ - 12PCS

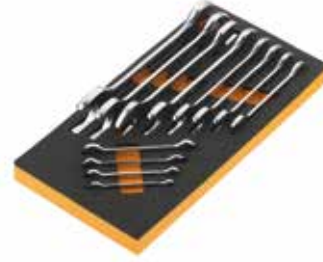

Made in
Turkey

İÇERİK: 6x7, 8x9, 10x11, 12x13, 14x15, 16x17, 18x19, 20x22, 21x23, 24x27, 25x28, 30x32 mm

KOD NO Code No	AĞIRLIK Weight	PAKET/KOLI Package/Box	FIYAT Price
RES0102	2220 gr	1 / 5 adet	

YILDIZ İKİ AĞIZ ANAHTAR SETİ - 8PCS

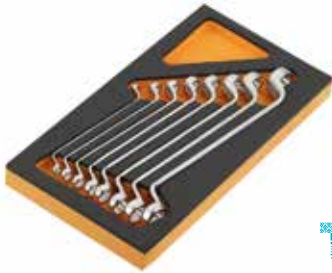

Made in
Turkey

İÇERİK: 6x7, 8x9, 10x11, 12x13, 14x15, 16x17, 18x19, 20x22 mm

KOD NO Code No	AĞIRLIK Weight	PAKET/KOLI Package/Box	FIYAT Price
RES0111	1225 gr	1 / 5 adet	

KOMBİNE ANAHTAR SETİ - 12PCS



Made in
Turkey

İÇERİK: 08, 09, 10, 11, 12, 13, 14, 15, 16, 17, 19, 22 mm

KOD NO Code No	AĞIRLIK Weight	PAKET/KOLI Package/Box	FIYAT Price
RES0121	1170 gr	1 / 5 adet	



Made in
Turkey

T SAPLI ALLEN SETİ - 6PCS

İÇERİK: ● 2.5, 3, 4, 5, 6, 8 mm

KOD NO Code No	AĞIRLIK Weight	PAKET/KOLI Package/Box	FIYAT Price
RES0502	540 gr	1 / 5 adet	

T SAPLI TORX SET - 6PCS

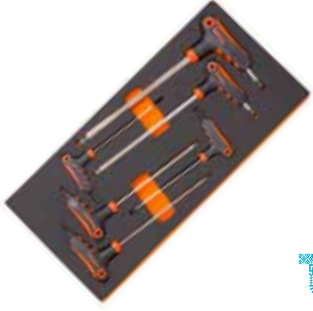

Made in
Turkey

İÇERİK: ⚙️ T10, T15, T20, T25, T30, T40

KOD NO Code No	AĞIRLIK Weight	PAKET/KOLİ Package/Box	FIYAT Price
RES0501	500 gr	1 / 5 adet	

RX TORNAVIDA SETİ - DÜZ - YILDIZ - 6PCS



Made in
Turkey

İÇERİK: ⚙️ PH0x80, PH1x100, PH2x125 ⚙️ 4.0x100, 5.0x100, 6.5x150

KOD NO Code No	AĞIRLIK Weight	PAKET/KOLİ Package/Box	FIYAT Price
RES0491	500 gr	1 / 5 adet	

RX LOKMA TORNAVIDA SETİ - 6PCS



Made in
Turkey

İÇERİK: 6, 7, 8, 10, 11, 13 mm

KOD NO Code No	AĞIRLIK Weight	PAKET/KOLİ Package/Box	FIYAT Price
RES0421	880 gr	1 / 5 adet	

RX TORX TORNAVIDA SETİ - 6PCS



Made in
Turkey

İÇERİK: ⚙️ T10, T15, T20, T25, T27, T30

KOD NO Code No	AĞIRLIK Weight	PAKET/KOLİ Package/Box	FIYAT Price
RES0451	500 gr	1 / 5 adet	

PENSE - YANKESKİ - KARGABURUN SET - 3PCS



İÇERİK: 180mm Kombine Pense, 160mm Yankeski, 160mm Kargaburun

KOD NO Code No	AĞIRLIK Weight	PAKET/KOLİ Package/Box	FIYAT Price
RES0301	760 gr	1 / 5 adet	

AYARLI PENSE VE KURBAĞACIK SETİ - 3PCS



İÇERİK: Ayarlı Pense, Fort Pense 250mm, Kurbağacık 250mm

KOD NO Code No	AĞIRLIK Weight	PAKET/KOLİ Package/Box	FIYAT Price
RES0311	1440 gr	1 / 5 adet	



1/4" 6 KÖŞE LOKMA SETİ - 54PCS

- K 4, 5, 6, 7, 8, 9, 10, 11, 12, 13 mm ● U 6, 7, 8, 9, 10, 11, 12, 13 mm
 - ★ T10, T15, T20, T25, T27, T30, T40 ● 4, 5.5, 6.5 mm
 - PH1, PH2, PH3
- Cırcır Kol, Uzatma 75-100 mm, Mafsal, T Kol, Lokma Tornavida, Bits Adaptörü Alyan: 1.5, 2, 2.5, 3, 4, 5, 6 mm
L Allen Kısa: 1.5, 2, 2.5, 3, 4, 5, 6, 8, 10 mm

KOD NO Code No	AĞIRLIK Weight	PAKET/KOLİ Package/Box	FİYAT Price
RES0201	1180 gr	1 / 5 adet	



1/2" 6 KÖŞE LOKMA SETİ - 23PCS

- 10, 11, 12, 13, 14, 15, 16, 17, 18, 19, 20, 21, 22, 23,24, 27, 30, 32 mm
- Cırcır Kol, Uzatma 125-250 mm, Mafsal, T Kol

KOD NO Code No	AĞIRLIK Weight	PAKET/KOLİ Package/Box	FİYAT Price
RES0221	3200 gr	1 / 5 adet	

10MM TORX - ALLEN - XZN BITS SETİ - 43PCS



- 3/8" Bits Adaptör, 1/2" Bits Adaptör
- 4, 5, 6, 7, 8, 10, 12mm
 - T20, T25, T30, T40, T45, T50, T55
 - M5, M6, M8, M10, M12
 - 4, 5, 6, 7, 8, 10, 12mm
 - T20, T25, T30, T40, T45, T50, T55
 - M5, M6, M8, M10, M12
 - M8, M9, M10

KOD NO Code No	AĞIRLIK Weight	PAKET/KOLİ Package/Box	FİYAT Price
RES0291	1320 gr	1 / 5 adet	

1/2" İÇ VE DIŞ TORX LOKMA SETİ - 14PCS



- E10, E12, E14, E16, E18, E20, E24
- ★ T30, T35, T40, T45, T50, T55, T60 mm

KOD NO Code No	AĞIRLIK Weight	PAKET/KOLİ Package/Box	FİYAT Price
RES0261	1080 gr	1 / 5 adet	

MINİ TORNAVİDA VE PENSE SETİ - 10PCS



İÇERİK: Oto Kontrol Kalem, Mikro Pense, Mikro Yankeski, Mikro Kargaburun
⊕ PH00x60, PH0x60, PH1x80 ⊖ 1,5x60, 3x100, 4x100 mm

KOD NO Code No	AĞIRLIK Weight	PAKET/KOLİ Package/Box	FİYAT Price
RES0701	380 gr	1 / 5 adet	

ÇEKİÇ VE KESKİ TAKIMI - 8PCS



4 mm nokta, 3 mm konik, 2 mm düz pim zımba, 12, 16 mm tesviyeci, 5 mm tırnak keski, 500 gr çekiç, 240 mm ince yassı keski

KOD NO Code No	AĞIRLIK Weight	PAKET/KOLİ Package/Box	FİYAT Price
RES0601	1280 gr	1 / 5 adet	





Güç ve Hassasiyet

- ◆ Bükülmeye ve kırılmaya karşı yüksek dayanıklılığa sahip Chrome Vanadium çeliğinden üretilmiştir.
- ◆ Hobi kullanımdan, zorlu koşullar altında, sanayinin aradığı en üst kalite değerlere uygundur.
- ◆ Civata başlarına kolay geçen profiller.
- ◆ Düşük imalat toleransları, anahtarların civata üzerine kusursuz oturmasını sağlar.

Ergonomi ve Geniş Ürün Gamı

- ◆ Pütürlü parlak yüzey avantajıyla yağlı ellerle bile güvenli kavrama.
- ◆ Keskin kenarları sıkıntısı 0'a indirilmiş ergonomik gövde tasarımı.
- ◆ Standart metrik ölçülerinde temini mümkün geniş portfolyo.
- ◆ Tek ya da setler veya modüller halinde temin edilebilir.

ANAHTARLAR



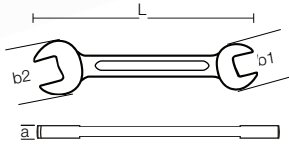

ÇATAL İKİ AĞIZ ANAHTARLAR

- İndüksiyonla sertleştirilmiş hassas ağızlar.
- Sıcak dövülmüş, sertleştirilmiş ve tavllanmış chrome vanadium çelik.
- Parlatılmış mat krom kaplama.
- Düşük imalat toleransları, anahtarların civata üzerine kusursuz oturmasını sağlar.
- Civata başlarına kolay geçen özel profiller.
- Kaymayı engelleyen ergonomik tasarım



KOD NO Code No	mm	L mm	a mm	b1 mm	b2 mm	AĞIRLIK Weight	PAKET/KOLİ Package/Box	FIYAT Price
RAA0607	6x7	99	4	17	15	18 gr	12/360 Adet	
RAA0809	8x9	110	4	21	19	28 gr	12/360 Adet	
RAA1011	10x11	120	5	24	23	44 gr	12/360 Adet	
RAA1213	12x13	134	6	29	27	64 gr	12/240 Adet	
RAA1415	14x15	147	6	32	30	92 gr	12/240 Adet	
RAA1617	16x17	164	7	38	35	120 gr	12/180 Adet	
RAA1819	18x19	180	7	41	38	148 gr	12/120 Adet	
RAA2022	20x22	192	8	47	41	195 gr	12/120 Adet	
RAA2123	21x23	215	9	48	45	243 gr	6/90 Adet	
RAA2427	24x27	235	9	57	51	352 gr	6/60 Adet	
RAA2528	25x28	255	10	60	54	440 gr	6/60 Adet	
RAA3032	30x32	265	11	67	62	548 gr	6/30 Adet	
RAA4146	41x46	370	13	91	80	1046 gr	5/15 Adet	



ÇATAL İKİ AĞIZ ANAHTAR SETLERİ

- İndüksiyonla sertleştirilmiş hassas ağızlar.
- Sıcak dövülmüş, sertleştirilmiş ve tavllanmış chrome vanadium çelik.
- Özel plastik kliptli ambalaj.
- Sık kullanılan ölçülerden oluşan setler.
- Asılabilir kliptli askı içinde takım.



KOD NO Code No	SET Set	İÇERİK Details	AĞIRLIK Weight	PAKET/KOLİ Package/Box	FIYAT Price
RAA6722	8pcs	6X7, 8X9, 10X11, 12X13, 14X15, 16X17, 18X19, 20X22 mm	768 gr	1/20 Adet	
RAA6732	12pcs	6X7, 8X9, 10X11, 12X13, 14X15, 16X17, 18X19, 20X22, 21x23, 24x27, 25x28, 30x32 mm	2475 gr	1/10 Adet	

KOMBİNE ANAHTARLAR

- İndüksiyonla sertleştirilmiş hassas ağızlar.
- Sıcak dövülmüş, sertleştirilmiş ve tavllanmış chrome vanad.
- Civata başlarına kolay geçen profiller.
- Kaymayı engelleyen ergonomik tasarım.
- Parlatılmış mazkrom kaplama

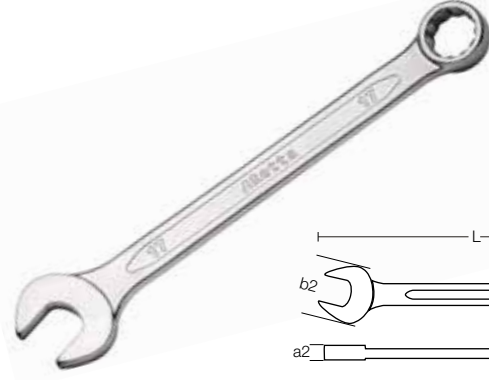

KOD NO Code No	mm	L mm	a1 mm	a2 mm	b1 mm	b2 mm	AĞIRLIK Weight	PAKET/KOLİ Package/Box	FİYAT Price
RKA1006	6	110	5	4	11	15	18 gr	12/360 Adet	
RKA1007	7	121	6	4	12,5	17	27 gr	12/360 Adet	
RKA1008	8	130	6	5	13	18	31 gr	12/360 Adet	
RKA1009	9	141	6,5	5	15	20,5	38 gr	12/360 Adet	
RKA1010	10	150	7	5,5	17	22	42 gr	12/360 Adet	
RKA1011	11	160	7	5,5	17,5	24,5	52 gr	12/360 Adet	
RKA1012	12	170	7,5	5,5	19	26	59 gr	12/360 Adet	
RKA1013	13	180	8,5	6	20	28	70 gr	12/360 Adet	
RKA1014	14	190	9	6	22	30	81 gr	12/240 Adet	
RKA1015	15	200	9	6	23	32	99 gr	12/192 Adet	
RKA1016	16	210	10	7	25	34,5	117 gr	12/180 Adet	
RKA1017	17	220	10	7	26	36,5	134 gr	12/120 Adet	
RKA1018	18	230	11	7	27,5	39	154 gr	12/120 Adet	
RKA1019	19	240	11	7	28	40	177 gr	6/120 Adet	
RKA1020	20	250	11,5	7,5	29,5	42	188 gr	6/90 Adet	
RKA1021	21	261	12	8	31	44,5	218 gr	6/90 Adet	
RKA1022	22	270	12	8	32	46	248 gr	6/90 Adet	
RKA1024	24	290	12	8	35	49,5	292 gr	6/60 Adet	
RKA1027	27	320	14	9	39	56	343 gr	6/60 Adet	
RKA1030	30	348	15	10	44	61	526 gr	6/30 Adet	
RKA1032	32	370	15,5	11	46	65	642 gr	6/30 Adet	

KOMBİNE ANAHTAR SETLERİ

- İndüksiyonla sertleştirilmiş hassas ağızlar.
- Sıcak dövülmüş, sertleştirilmiş ve tavllanmış chrome vanadium çelik.
- Özel plastik klipsli ambalaj.
- Sık kullanılan ölçülerden oluşan setler.
- Asılabilir klipsli askı içinde takım.



KOD NO Code No	SET Set	İÇERİK Details	AĞIRLIK Weight	PAKET/KOLİ Package/Box	FİYAT Price
RKA0822	12pcs	8, 9, 10, 11, 12, 13 14, 15, 16, 17, 19, 22 mm	1327 gr	1/10 Adet	
RKA0632	20pcs	6, 7, 8, 9, 10, 11, 12, 13 14, 15, 16, 17, 18, 19, 21, 22, 24, 27, 30, 32 mm	3699 gr	1/5 Adet	

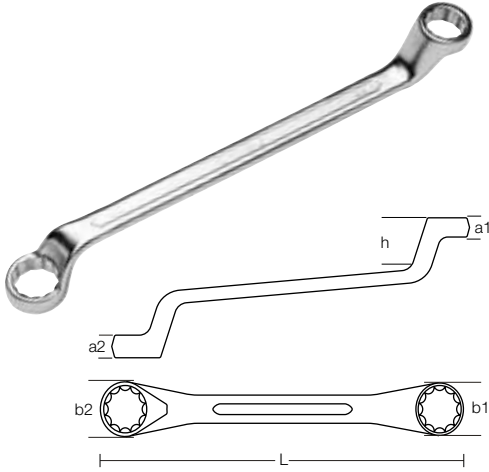

YILDIZ İKİ AĞIZ ANAHTARLAR

- İndüksiyonla sertleştirilmiş hassas ağızlar.
- Sıcak dövülmüş, sertleştirilmiş ve tavllanmış chrome vanadium çelik.
- Parlatılmış mat krom kaplama.
- Civata başlarına kolay geçen profiller.
- Düşük imalat toleransları, anahtarların civata üzerine kusursuz oturmasını sağlar.



KOD NO Code No	mm	L mm	a1 mm	a2 mm	b1 mm	b2 mm	h mm	AĞIRLIK Weight	PAKET/KOLİ Package/Box	FIYAT Price
RYA0607	6x7	165	6	5	13	6	20,7	42 gr	12/360 Adet	
RYA0809	8x9	180	6,6	6	16	9	21,7	58 gr	12/360 Adet	
RYA1011	10x11	195	8,5	7	18	12	23,6	80 gr	12/240 Adet	
RYA1213	12x13	215	9	8	21	20	25,1	112 gr	12/180 Adet	
RYA1415	14x15	230	10	9	24	22	26,1	143 gr	12/120 Adet	
RYA1617	16x17	250	11	10	27	25	27,1	188 gr	12/120 Adet	
RYA1819	18x19	265	11	11	30	28	28,6	223 gr	6/90 Adet	
RYA2022	20x22	285	13	12	34	31	31,0	305 gr	6/90 Adet	
RYA2123	21x23	305	13	12	35	32	33,0	338 gr	6/60 Adet	
RYA2427	24x27	325	14	13	41	36	34,5	410 gr	6/60 Adet	
RYA2528	25x28	340	15	14	42	38	35,5	483 gr	6/30 Adet	
RYA3032	30x32	375	16	16	47	44	37,4	636 gr	6/30 Adet	
RYA3641	36x41	435	19	19	60	53	40,4	1058 gr	5/25 Adet	
RYA4146	41x46	460	20	20	68	60	42,8	1256 gr	5/15 Adet	

YILDIZ İKİ AĞIZ ANAHTAR SETLERİ



- İndüksiyonla sertleştirilmiş hassas ağızlar.
- Sıcak dövülmüş, sertleştirilmiş ve tavllanmış chrome vanadium çelik.
- Özel plastik klipsli ambalaj.
- Sık kullanılan ölçülerden oluşan setler.
- Asılabilir klipsli askı içinde takım.



KOD NO Code No	SET Set	İÇERİK Details	AĞIRLIK Weight	PAKET/KOLİ Package/Box	FIYAT Price
RYA6722	8pcs	6X7, 8X9, 10X11, 12X13, 14X15, 16X17, 18X19, 20X22 mm	1182 gr	1/10 Adet	
RYA6732	12pcs	6X7, 8X9, 10X11, 12X13, 14X15, 16X17, 18X19, 20X22, 21x23, 24x27, 25x28, 30x32 mm	3286 gr	1/6 Adet	

YILDIZ CIRCİR ANAHTARLAR

- İndüksiyonla sertleştirilmiş hassas ağızlar.
- Sıcak dövülmüş, sertleştirilmiş ve tavllanmış chrome vanadium çelik.
- Civata başlarına kolay geçen özel proller.
- 72 diş çift taraflı circir mekanizması
- Düşük imalat toleransları, anahtarların civata üzerine kusursuz oturmasını sağlar.

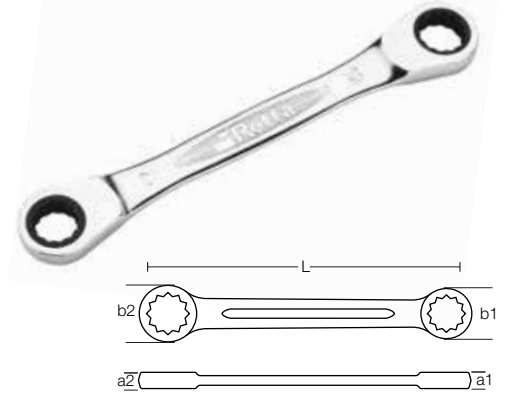

KOD NO Code No	mm	L mm	a1 mm	a2 mm	b1 mm	b2 mm	AĞIRLIK Weight	PAKET/KOLİ Package/Box	FİYAT Price
RCY0810	8x10	131	7	6	21	18	53 gr	10 / 200 Adet	
RCY1011	10x11	150	7	7	24	21	78 gr	10 / 200 Adet	
RCY1213	12x13	170	8	8	28	24	110 gr	10 / 100 Adet	
RCY1314	13x14	190	8	8	29	27	135 gr	10 / 100 Adet	
RCY1719	17x19	230	11	10	36	35	236 gr	10 / 60 Adet	

R-DRIVE CIRCİR KOMBİNE ANAHTARLAR

- İndüksiyonla sertleştirilmiş hassas ağızlar.
- Sıcak dövülmüş, sertleştirilmiş ve tavllanmış chrome vanadium çelik.
- Civata başlarına kolay geçen özel profiller.
- 72 diş çift taraflı circir mekanizması
- Düşük imalat toleransları, anahtarların civata üzerine kusursuz oturmasını sağlar.



Tek Ürün 7 Farklı Form

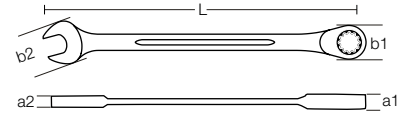
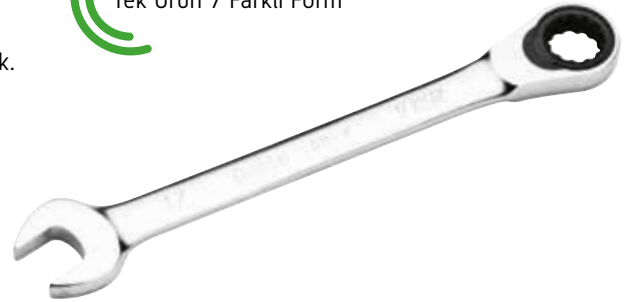

KOD NO Code No	mm	inch	star	L mm	a1 mm	a2 mm	b1 mm	b2 mm	AĞIRLIK Weight	PAKET/KOLİ Package/Box	FİYAT Price
RCA0108	8	5/16"	E10	140	7	8	18	18	35 gr	10 / 300 adet	
RCA0109	9	11/32"	E11	150	7	5	19	20	40 gr	10 / 200 adet	
RCA0111	11	7/16"	E14	165	8	5	23	24	61 gr	10 / 200 adet	
RCA0112	12	15/32"	-	171	9	5	24	26	84 gr	10 / 200 adet	
RCA0113	13	1/2"	E16	180	10	7	26	28	95 gr	10 / 200 adet	
RCA0114	14	9/16"	E18	190	10	7	27	31	105 gr	10 / 200 adet	
RCA0115	15	9/32"	-	200	10	7	29	32	126 gr	10 / 200 adet	
RCA0116	16	5/8"	E20	207	11	7	30	34	143 gr	10 / 100 adet	
RCA0117	17	21/32"	-	225	11	8	32	36	180 gr	10 / 100 adet	
RCA0119	19	3/4"	E24	248	12	9	35	41	217 gr	10 / 60 adet	
RCA0122	22	7/8"	E28	289	14	10	41	46	329 gr	10 / 60 adet	
RCA0124	24	15/16"	E30	322	14	11	46	52	460 gr	10 / 60 adet	



CIRCIR KOMBİNE ANAHTARLAR



- Sıcak dövülmüş, sertleştirilmiş ve tavllanmış chrome vanadium çelik.
- Küçük ve yüksek performanslı 72 dişliden oluşan hassas circir mekanizması.
- Kalitesi test edilmiş circir teknolojisi düz ve yuvarlak kafa içerisinde gömülü olduğundan etkin olarak çalışmaya imkan tanır..

KOD NO Code No	ÖLÇÜ mm	PAKET/KOLİ Package/Box	FİYAT Price
RCA0208	8 mm	10 / 180 adet	
RCA0212	12 mm	10 / 180 adet	
RCA0214	14 mm	10 / 120 adet	
RCA0215	15 mm	10 / 120 adet	
RCA0219	19 mm	10 / 60 adet	
RCA0221	21 mm	10 / 60 adet	
RCA0222	22 mm	10 / 60 adet	
RCA0224	24 mm	10 / 60 adet	
RCA0227	27 mm	10 / 60 adet	
RCA0230	30 mm	10 / 60 adet	
RCA0232	32 mm	10 / 60 adet	

MAFSALLI CIRCIR KOMBİNE ANAHTARLAR

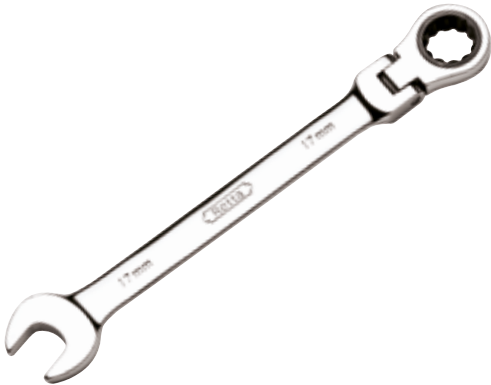

- Sıcak dövülmüş, sertleştirilmiş ve tavllanmış chrome vanadium çelik.
- Küçük ve yüksek performanslı 72 dişliden oluşan hassas circir mekanizması.
- Kalitesi test edilmiş circir teknolojisi düz ve yuvarlak kafa içerisinde gömülü olduğundan etkin olarak çalışmaya imkan tanır..

KOD NO Code No	ÖLÇÜ mm	PAKET/KOLİ Package/Box	FİYAT Price
RCA0308	8 mm	10 / 180 adet	
RCA0312	12 mm	10 / 180 adet	
RCA0314	14 mm	10 / 120 adet	
RCA0315	15 mm	10 / 60 adet	
RCA0317	17 mm	10 / 60 adet	
RCA0319	19 mm	10 / 60 adet	

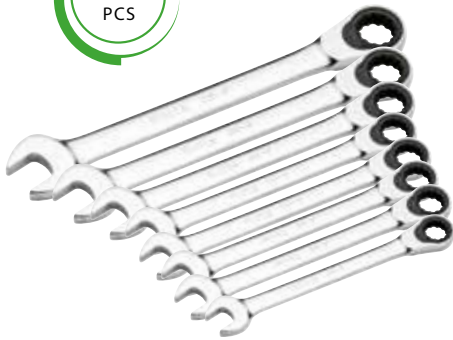
8
PCS

R-DRIVE CIRCIR KOMBİNE ANAHTAR SETİ

- Sıcak dövülmüş, sertleştirilmiş ve tavllanmış chrome vanadium çelik.
- Küçük ve yüksek performanslı 72 dişliden oluşan hassas circir mekanizması.
- Sık kullanılan ölçülerden oluşan setler.



KOD NO Code No	SET Set	İÇERİK Details	AĞIRLIK Weight	PAKET/KOLİ Package/Box	FİYAT Price
RCS0819	8pcs	8, 10, 11, 12, 13 14, 17, 19 mm	948 gr	1/5 Adet	

CIRCİR KOMBİNE ANAHTARLAR

- İndüksiyonla sertleştirilmiş hassas ağızlar.
- Sıcak dövülmüş, sertleştirilmiş ve tavllanmış chrome vanadium çelik.
- Parlatılmış mat krom kaplama.
- Civata başlarına kolay geçen özel proşler.
- 72 diş circir mekanizması sayesinde dar alanda seri çalışma sağlar
- Düşük imalat toleransları, anahtarların civata üzerine kusursuz oturmasını sağlar

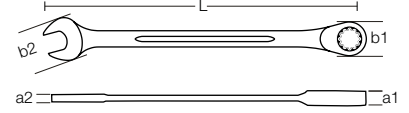

KOD NO Code No	mm	L mm	a1 mm	a2 mm	b1 mm	b2 mm	AĞIRLIK Weight	PAKET/KOLİ Package/Box	FIYAT Price
RCA0508	8	138	6	5	18	17	39 gr	10 / 200 Adet	
RCA0510	10	159	7	6	21	18	55 gr	10 / 200 Adet	
RCA0512	12	172	8	6	24	22	75 gr	10 / 200 Adet	
RCA0513	13	185	8	7	24	24	99 gr	10 / 200 Adet	
RCA0514	14	193	9	7	28	32	121 gr	10 / 100 Adet	
RCA0515	15	200	9	8	30	33	146 gr	10 / 100 Adet	
RCA0517	17	227	10	8	32	37	191 gr	10 / 100 Adet	
RCA0519	19	250	11	8	35	41	234 gr	10 / 60 Adet	
RCA0521	21	290	13	10	41	46	352 gr	10 / 30 Adet	
RCA0522	22	290	13	9	41	46	336 gr	10 / 30 Adet	
RCA0524	24	321	15	11	46	52	478 gr	10 / 30 Adet	

MAFSALLI CIRCİR KOMBİNE ANAHTARLAR

- İndüksiyonla sertleştirilmiş hassas ağızlar.
- Sıcak dövülmüş, sertleştirilmiş ve tavllanmış chrome vanadium çelik.
- Parlatılmış mat krom kaplama.
- Düşük imalat toleransları, anahtarların civata üzerine kusursuz oturmasını sağlar.
- Bükülebilir circir mekanizması ile istenilen açıda çalışabilme.
- Civata başlarına kolay geçen özel profiller.
- 72 diş circir mekanizması 180° hareketli circir aparatı

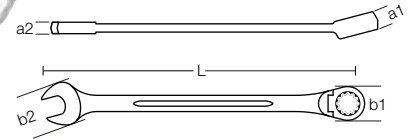
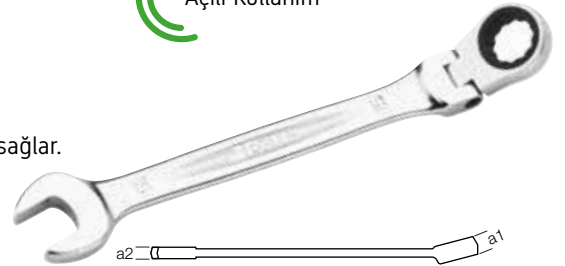

KOD NO Code No	mm	L mm	a1 mm	a2 mm	b1 mm	b2 mm	AĞIRLIK Weight	PAKET/KOLİ Package/Box	FIYAT Price
RCA0608	8	144	6	5	19	17	41 gr	10 / 200 Adet	
RCA0610	10	162	7	6	22	21	65 gr	10 / 200 Adet	
RCA0612	12	178	8	6	26	25	101 gr	10 / 200 Adet	
RCA0613	13	180	8	7	26	27	112 gr	10 / 200 Adet	
RCA0614	14	192	9	8	28	29	133 gr	10 / 100 Adet	
RCA0615	15	198	9	8	28	31	144 gr	10 / 100 Adet	
RCA0617	17	227	10	9	32	36	204 gr	10 / 100 Adet	
RCA0619	19	250	11	10	35	40	276 gr	10 / 60 Adet	
RCA0621	21	287	13	10	40	46	380 gr	10 / 30 Adet	
RCA0622	22	287	13	10	40	46	377 gr	10 / 30 Adet	
RCA0624	24	326	15	11	46	52	551 gr	10 / 30 Adet	



4 IN 1 CIRCIR KOMBİNE ANAHTAR

- Sıcak dövülmüş, sertleştirilmiş ve tavllanmış chrome vanadium çelik.
- Küçük ve yüksek performanslı 72 dişliden oluşan hassas circir mekanizması.

KOD NO Code No	mm	AĞIRLIK Weight	PAKET/KOLİ Package/Box	FİYAT Price
RCA1019	10 mm, 13 mm, 17 mm, 19 mm	135 gr	10/100 Adet	

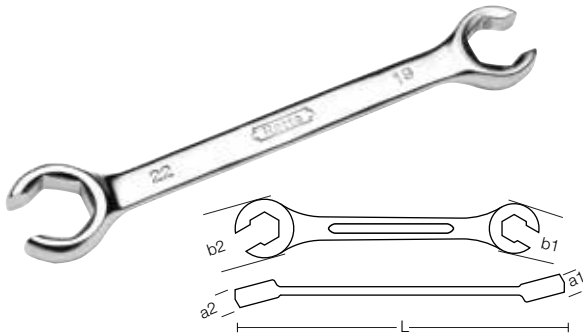

RAKOR ANAHTARLAR

- İndüksiyonla sertleştirilmiş hassas ağızlar.
- Sıcak dövülmüş, sertleştirilmiş ve tavllanmış chrome vanadium çelik.
- Parlatılmış mat krom kaplama.
- Hidro-Pnomatik rakorlar için özel tasarım.

KOD NO Code No	mm	L mm	a1 mm	a2 mm	b1 mm	b2 mm	AĞIRLIK Weight	PAKET/KOLİ Package/Box	FİYAT Price
RRA0810	8x10	126	9	9	20	22	44 gr	12 / 120 adet	
RRA0911	9x11	140	10	10	24	22	69 gr	12 / 120 adet	
RRA1012	10x12	140	10	10	25	22	68 gr	12 / 120 adet	
RRA1113	11x13	140	10	10	25	25	66 gr	12 / 120 adet	
RRA1214	12x14	165	11	11	28	25	99 gr	12 / 120 adet	
RRA1314	13x14	165	11	11	28	28	100 gr	12 / 120 adet	
RRA1517	15x17	173	11	11	30	28	108 gr	6 / 120 adet	
RRA1719	17x19	173	12	12	31	29	118 gr	6 / 120 adet	
RRA1922	19x22	199	13	12	36	32	165 gr	6 / 60 adet	
RRA2224	22x24	215	14	14	39	31	218 gr	6 / 60 adet	

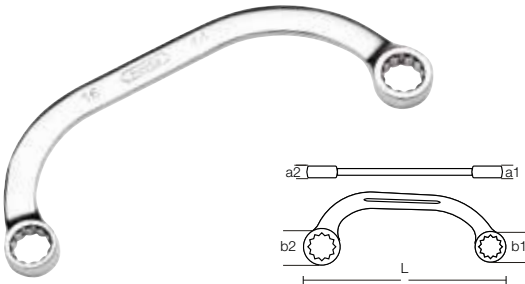

YARIM AY ANAHTARLAR

- İndüksiyonla sertleştirilmiş hassas ağızlar.
- Sıcak dövülmüş, sertleştirilmiş ve tavllanmış chrome vanadium çelik.
- Parlatılmış mat krom kaplama.

KOD NO Code No	mm	L mm	a1 mm	a2 mm	b1 mm	b2 mm	AĞIRLIK Weight	PAKET/KOLİ Package/Box	FİYAT Price
RAY1012	10x12	145	7	7	19	16	57 gr	12 / 120 Adet	
RAY1113	11x13	170	8	8	21	18	104 gr	12 / 120 Adet	
RAY1315	13x15	195	10	10	26	23	144 gr	12 / 120 Adet	
RAY1415	14x15	195	11	10	26	23	163 gr	12 / 120 Adet	
RAY1922	19x22	264	11	11	33	31	264 gr	6 / 60 Adet	

L ALLEN ANAHTARLAR KISA

- Korozyona karşı mat chrome kaplama.
- Anahtarların kolay oturması için yuvarlatılmış uçlar.
- Sertleştirilmiş kaliteli chrome vanadium malzeme.
- Miknatıslı uçlar sayesinde tam kavrama



KOD NO Code No	mm	L1 mm	L2 mm	AĞIRLIK Weight	PAKET/KOLİ Package/Box	FIYAT Price
RKL3040	4	73	28	8 gr	24 / 1800 adet	
RKL3050	5	84	32,5	13 gr	12 / 900 adet	
RKL3060	6	95	37,5	29 gr	12 / 576 adet	
RKL3080	8	106	43,5	58 gr	12 / 384 adet	
RKL3100	10	120	49,5	101 gr	12 / 240 adet	
RKL3120	12	135	56,5	163 gr	12 / 108 adet	
RKL3130	13	145	63	205 gr	12 / 72 adet	
RKL3140	14	152	69	253 gr	12 / 72 adet	
RKL3170	17	175	79	433 gr	12 / 72 adet	
RKL3190	19	195	88	602 gr	6 / 36 adet	

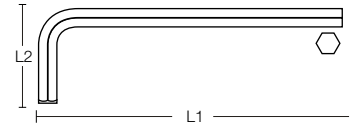

L ALLEN ANAHTARLAR TOPBAŞLI KISA

- Korozyona karşı mat chrome kaplama.
- Anahtarların kolay oturması için yuvarlatılmış uçlar.
- Sertleştirilmiş kaliteli chrome vanadium malzeme.
- Miknatıslı uçlar sayesinde tam kavrama.



KOD NO Code No	mm	L1 mm	L2 mm	AĞIRLIK Weight	PAKET/KOLİ Package/Box	FIYAT Price
RTB1040	4	73	28	12 gr	24 / 1800 adet	
RTB1080	8	106	43,5	56 gr	12 / 384 adet	
RTB1100	10	120	49,5	100 gr	12 / 240 adet	





L ALLEN ANAHTARLAR UZUN

- Korozyona karşı mat chrome kaplama.
- Anahtarların kolay oturması için yuvarlatılmış uçlar.
- Sertleştirilmiş kaliteli chrome vanadium malzeme.



KOD NO Code No	mm	L1 mm	L2 mm	AĞIRLIK Weight	PAKET/KOLİ Package/Box	FİYAT Price
RUL4040	4	143	28	18 gr	24 / 480 adet	
RUL4050	5	164	32,5	21 gr	24 / 480 adet	
RUL4060	6	185	37,5	54 gr	12 / 240 adet	
RUL4080	8	206	43,5	101 gr	12 / 144 adet	
RUL4100	10	232	49,5	174 gr	12 / 108 adet	

L ALLEN ANAHTARLAR TOPBAŞLI UZUN

- Korozyona karşı mat chrome kaplama.
- Anahtarların kolay oturması için yuvarlatılmış uçlar.
- Sertleştirilmiş kaliteli chrome vanadium malzeme.

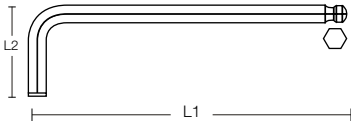

KOD NO Code No	mm	L1 mm	L2 mm	AĞIRLIK Weight	PAKET/KOLİ Package/Box	FİYAT Price
RTB5040	4	143	28	17 gr	24 / 480 adet	
RTB5050	5	164	32,5	31 gr	24 / 480 adet	
RTB5060	6	185	37,5	52 gr	12 / 240 adet	
RTB5080	8	206	43,5	100 gr	12 / 144 adet	
RTB5100	10	232	49,5	171 gr	12 / 108 adet	

L ANAHTARLAR - XZN - 12 KÖŞE

- Korozyona karşı mat chrome kaplama.
- Anahtarların kolay oturması için yuvarlatılmış uçlar.
- Sertleştirilmiş kaliteli chrome vanadium malzeme.



KOD NO Code No	mm	L1 mm	L2 mm	AĞIRLIK Weight	PAKET/KOLİ Package/Box	FİYAT Price
ROT1005	M5	75	30	17 gr	24 / 1800 adet	
ROT1006	M6	86	34	27 gr	24 / 1800 adet	
ROT1008	M8	98	40	46 gr	24 / 1800 adet	
ROT1010	M10	110	46	84 gr	12 / 900 adet	
ROT1012	M12	124	52	119 gr	12 / 900 adet	
ROT1014	M14	139	59	171 gr	12 / 576 adet	

L TORX ANAHTARLAR KISA

- Korozyona karşı mat chrome kaplama.
- Anahtarların kolay oturması için yuvarlatılmış uçlar.
- Sertleştirilmiş kaliteli chrome vanadium malzeme.



KOD NO Code No		L1 mm	L2 mm	AĞIRLIK Weight	PAKET/KOLİ Package/Box	FİYAT Price
RKT6025	T25	70	25	10 gr	24 / 1800 adet	
RKT6027	T27	78	25	15 gr	24 / 1800 adet	
RKT6030	T30	86	30	23 gr	12 / 900 adet	
RKT6040	T40	97	33	34 gr	12 / 576 adet	
RKT6045	T45	110	37	49 gr	12 / 384 adet	
RKT6050	T50	122	40	56 gr	12 / 384 adet	

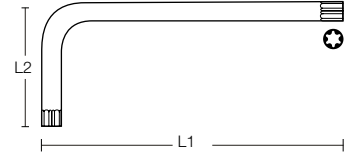

L TORX ANAHTARLAR UZUN

- Korozyona karşı mat chrome kaplama.
- Anahtarların kolay oturması için yuvarlatılmış uçlar.
- Sertleştirilmiş kaliteli chrome vanadium malzeme.



KOD NO Code No		L1 mm	L2 mm	AĞIRLIK Weight	PAKET/KOLİ Package/Box	FİYAT Price
RUT8025	T25	130	25	18 gr	24 / 1800 adet	
RUT8027	T27	145	29	26 gr	24 / 1800 adet	
RUT8030	T30	165	35	40 gr	12 / 900 adet	
RUT8040	T40	183	39	60 gr	12 / 576 adet	
RUT8045	T45	200	44	90 gr	12 / 384 adet	
RUT8050	T50	225	52	124 gr	12 / 384 adet	

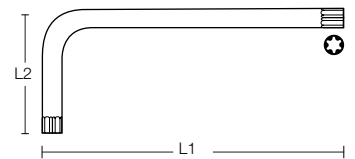



L TORX ANAHTARLAR KISA - DELİKLİ

- Korozyona karşı mat chrome kaplama.
- Anahtarların kolay oturması için yuvarlatılmış uçlar.
- Sertleştirilmiş kaliteli chrome vanadium malzeme.

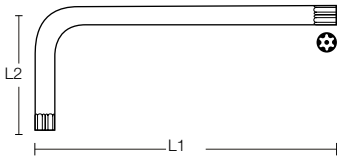

KOD NO Code No		L1 mm	L2 mm	AĞIRLIK Weight	PAKET/KOLİ Package/Box	FİYAT Price
RKD7025	T 25	70	25	11 gr	12 / 900 adet	
RKD7027	T 27	78	25	12 gr	12 / 900 adet	
RKD7030	T 30	86	30	21 gr	12 / 576 adet	
RKD7040	T 40	97	33	35 gr	12 / 576 adet	
RKD7045	T 45	110	37	47 gr	12 / 576 adet	
RKD7050	T 50	122	40	52 gr	12 / 576 adet	



L TORX ANAHTARLAR UZUN - DELİKLİ

- Korozyona karşı mat chrome kaplama.
- Anahtarların kolay oturması için yuvarlatılmış uçlar.
- Sertleştirilmiş kaliteli chrome vanadium malzeme.

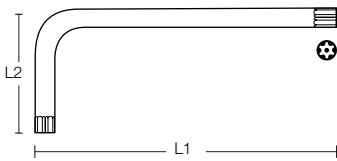

KOD NO Code No		L1 mm	L2 mm	AĞIRLIK Weight	PAKET/KOLİ Package/Box	FİYAT Price
RUD9025	T 25	130	25	18 gr	24 / 1800 adet	
RUD9027	T 27	145	29	22 gr	24 / 1800 adet	
RUD9030	T 30	165	35	40 gr	12 / 900 adet	
RUD9040	T 40	183	39	63 gr	12 / 576 adet	
RUD9045	T 45	200	44	84 gr	12 / 384 adet	
RUD9050	T 50	225	52	125 gr	12 / 384 adet	

L ALLEN ANAHTAR TAKIMI KISA

- Korozyona karşı nikel kaplama
- Anahtarların kolay oturması için yuvarlatılmış uçlar
- İstenilen boyun kolay seçimini sağlayan klips
- Sertleştirilmiş kaliteli chrome vanadium malzeme



KOD NO Code No	SET Set	İÇERİK Details	AĞIRLIK Weight	PAKET/KOLİ Package/Box	FIYAT Price
RAT3009	9 pcs	1,5 mm, 2 mm, 2,5 mm, 3 mm, 4 mm, 5 mm, 6 mm, 8 mm, 10 mm	256 gr	12 / 72 adet	

L ALLEN ANAHTAR TAKIMI UZUN

- Korozyona karşı nikel kaplama
- Anahtarların kolay oturması için yuvarlatılmış uçlar
- İstenilen boyun kolay seçimini sağlayan klips
- Sertleştirilmiş kaliteli chrome vanadium malzeme



KOD NO Code No	SET Set	İÇERİK Details	AĞIRLIK Weight	PAKET/KOLİ Package/Box	FIYAT Price
RAT4009	9 pcs	15 mm, 2 mm, 2,5 mm, 3 mm, 4 mm, 5 mm, 6 mm, 8 mm, 10 mm	418 gr	12 / 48 adet	

L ALLEN ANAHTAR TAKIMI TOPBAŞLI UZUN

- Korozyona karşı nikel kaplama
- Anahtarların kolay oturması için yuvarlatılmış uçlar
- İstenilen boyun kolay seçimini sağlayan klips
- Sertleştirilmiş kaliteli chrome vanadium malzeme



KOD NO Code No	SET Set	İÇERİK Details	AĞIRLIK Weight	PAKET/KOLİ Package/Box	FIYAT Price
RAT5009	9 pcs	15 mm, 2 mm, 2,5 mm, 3 mm, 4 mm, 5 mm, 6 mm, 8 mm, 10 mm	422 gr	12 / 48 adet	



9
PCS



L ALLEN ANAHTAR TAKIMI TOPBAŞLI KISA

- Korozyona karşı nikel kaplama
- Anahtarların kolay oturması için yuvarlatılmış uçlar
- İstenilen boyun kolay seçimini sağlayan klips
- Sertleştirilmiş kaliteli chrome vanadium malzeme



Made in
Turkey

KOD NO Code No	SET Set	İÇERİK Details	AĞIRLIK Weight	PAKET/KOLİ Package/Box	FİYAT Price
RAT0908	9 pcs	1,5 mm, 2 mm, 2,5 mm, 3 mm, 4 mm, 5 mm, 6 mm, 8 mm, 10 mm	256 gr	12 / 72 adet	

9
PCS



L TORX ANAHTAR TAKIMI KISA

- Korozyona karşı nikel kaplama
- Anahtarların kolay oturması için yuvarlatılmış uçlar
- İstenilen boyun kolay seçimini sağlayan klips
- Sertleştirilmiş kaliteli chrome vanadium malzeme



Made in
Turkey

KOD NO Code No	SET Set	İÇERİK Details	AĞIRLIK Weight	PAKET/KOLİ Package/Box	FİYAT Price
RAT6009	9 pcs	T10, T15, T20, T25, T27, T30, T40, T45, T50	250 gr	12 / 72 adet	

9
PCS



L TORX ANAHTAR TAKIMI UZUN

- Korozyona karşı nikel kaplama
- Anahtarların kolay oturması için yuvarlatılmış uçlar
- İstenilen boyun kolay seçimini sağlayan klips
- Sertleştirilmiş kaliteli chrome vanadium malzeme



Made in
Turkey

KOD NO Code No	SET Set	İÇERİK Details	AĞIRLIK Weight	PAKET/KOLİ Package/Box	FİYAT Price
RAT8009	9 pcs	T10, T15, T20, T25, T27, T30, T40, T45, T50	421 gr	12 / 48 adet	

L TORX ANAHTAR TAKIMI KISA - DELİKLİ

- Korozyona karşı nikel kaplama
- Anahtarların kolay oturması için yuvarlatılmış uçlar
- İstenilen boyun kolay seçimini sağlayan klips
- Sertleştirilmiş kaliteli chrome vanadium malzeme

9
PCS



KOD NO Code No	SET Set	İÇERİK Details	AĞIRLIK Weight	PAKET/KOLİ Package/Box	FİYAT Price
RAT7009	9 pcs	T10, T15, T20, T25, T27, T30, T40, T45, T50	247 gr	12 / 48 adet	

L TORX ANAHTAR TAKIMI UZUN - DELİKLİ

- Korozyona karşı nikel kaplama
- Anahtarların kolay oturması için yuvarlatılmış uçlar
- İstenilen boyun kolay seçimini sağlayan klips
- Sertleştirilmiş kaliteli chrome vanadium malzeme

9
PCS



KOD NO Code No	SET Set	İÇERİK Details	AĞIRLIK Weight	PAKET/KOLİ Package/Box	FİYAT Price
RAT9009	9 pcs	T10, T15, T20, T25, T27, T30, T40, T45, T50	418 gr	12 / 48 adet	

L ALLEN ANAHTAR TAKIMI KISA

- Korozyona karşı mat chrome kaplama
- Anahtarların kolay oturması için yuvarlatılmış uçlar
- İstenilen boyun kolay seçimini sağlayan klips
- Sertleştirilmiş kaliteli chrome vanadium malzeme

13
PCS



KOD NO Code No	SET Set	İÇERİK Details	AĞIRLIK Weight	PAKET/KOLİ Package/Box	FİYAT Price
RAT0913	13 pcs	2mm, 2.5mm, 3mm, 4mm, 5mm, 6mm, 7mm, 8mm, 10mm, 12mm, 14mm, 17mm, 19 mm	1797 gr	12 / 10 adet	



T SAPLI ALLEN ANAHTARLAR

- Özel tasarım ergonomik sap
- Korozyona karşı parlak chrome kaplama
- Anahtarların kolay oturması için yuvarlatılmış uçlar
- Sıcak çekilmiş, sertleştirilmiş ve tavllanmış CR-V malzeme

KOD NO Code No	mm	L1 mm	L2 mm	L3 mm	AĞIRLIK Weight	PAKET/KOLİ Package/Box	FİYAT Price
RXA1020	2	135	94	18	34 gr	12 / 96 adet	
RXA1025	2.5	145	104	18	36 gr	12 / 96 adet	
RXA1030	3	155	116	18	39 gr	12 / 96 adet	
RXA1040	4	175	125	22	70 gr	12 / 96 adet	
RXA1050	5	195	145	22	85 gr	12 / 96 adet	
RXA1060	6	215	167	22	109 gr	12 / 96 adet	
RXA1080	8	245	183	28	207 gr	12 / 96 adet	

CHROME
CrV
VANADIUM

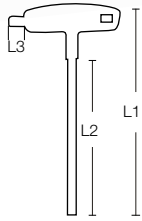

T SAPLI ALLEN ANAHTARLAR - TOPBAŞLI

- Özel tasarım ergonomik sap
- Korozyona karşı parlak chrome kaplama
- Anahtarların kolay oturması için yuvarlatılmış uçlar
- Sıcak çekilmiş, sertleştirilmiş ve tavllanmış CR-V malzeme

KOD NO Code No	mm	L1 mm	L2 mm	L3 mm	AĞIRLIK Weight	PAKET/KOLİ Package/Box	FİYAT Price
RTB2020	2	135	90	15	33 gr	12 / 96 adet	
RTB2025	2.5	145	103	15	36 gr	12 / 96 adet	
RTB2030	3	157	117	18	39 gr	12 / 96 adet	
RTB2040	4	175	125	21	69 gr	12 / 96 adet	
RTB2050	5	195	144	22	85 gr	12 / 96 adet	
RTB2060	6	220	168	22	107 gr	12 / 96 adet	
RTB2080	8	245	184	28	207 gr	12 / 96 adet	

CHROME
CrV
VANADIUM

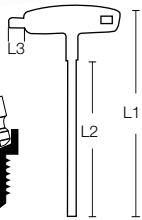

T SAPLI TORX ANAHTAR - DELİKSİZ

- Özel tasarım ergonomik sap
- Korozyona karşı parlak chrome kaplama
- Anahtarların kolay oturması için yuvarlatılmış uçlar
- Sıcak çekilmiş, sertleştirilmiş ve tavllanmış S2 malzeme

KOD NO Code No	mm	L1 mm	L2 mm	L3 mm	AĞIRLIK Weight	PAKET/KOLİ Package/Box	FİYAT Price
RXT2010	T10 x 100 mm	140	100	12	38 gr	12 / 96 adet	
RXT2015	T15 x 100 mm	140	100	12	38 gr	12 / 96 adet	
RXT2020	T20 x 100 mm	140	100	12	38 gr	12 / 96 adet	
RXT2025	T25 x 150 mm	200	150	20	107 gr	12 / 96 adet	
RXT2030	T30 x 150 mm	200	150	20	108 gr	12 / 96 adet	
RXT2040	T40 x 150 mm	200	150	20	110 gr	12 / 96 adet	

CHROME
CrV
VANADIUM

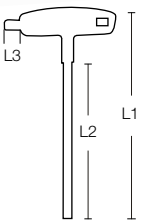

T SAPLI ALLEN ANAHTAR TAKIMI

- Özel tasarım ergonomik sap
- Korozyona karşı parlak chrome kaplama
- Anahtarların kolay oturması için yuvarlatılmış uçlar
- Sıcak çekilmiş, sertleştirilmiş ve tavllanmış CR-V malzeme

CHROME
CrV
VANADIUM



6
PCS



KOD NO Code No	SET Set	İÇERİK Details	AĞIRLIK Weight	PAKET/KOLİ Package/Box	FİYAT Price
RTA0600	6 pcs	2.5mm, 3mm, 4mm, 5mm, 6mm, 8mm	713 gr	1 / 12 adet	

T SAPLI ALLEN ANAHTAR TAKIMI - TOPBAŞLI

- Özel tasarım ergonomik sap
- Korozyona karşı parlak chrome kaplama
- Anahtarların kolay oturması için yuvarlatılmış uçlar
- Sıcak çekilmiş, sertleştirilmiş ve tavllanmış CR-V malzeme

CHROME
CrV
VANADIUM



6
PCS



KOD NO Code No	SET Set	İÇERİK Details	AĞIRLIK Weight	PAKET/KOLİ Package/Box	FİYAT Price
RTB2000	6 pcs	2,5mm, 3mm, 4mm, 5mm, 6mm, 8mm	576 gr	1 / 12 adet	

T SAPLI TORX ANAHTAR TAKIMI - DELİKSİZ

- Özel tasarım ergonomik sap
- Korozyona karşı parlak chrome kaplama
- Anahtarların kolay oturması için yuvarlatılmış uçlar
- Sıcak çekilmiş, sertleştirilmiş ve tavllanmış CR-V malzeme

CHROME
CrV
VANADIUM



6
PCS



KOD NO Code No	SET Set	İÇERİK Details	AĞIRLIK Weight	PAKET/KOLİ Package/Box	FİYAT Price
RTA0603	6 pcs	T10, T15, 20, T25, T30, T40	582 gr	1 / 12 adet	

T SAPLI TORX ANAHTAR TAKIMI - DELİKLİ

- Özel tasarım ergonomik sap
- Korozyona karşı parlak chrome kaplama
- Anahtarların kolay oturması için yuvarlatılmış uçlar
- Sıcak çekilmiş, sertleştirilmiş ve tavllanmış CR-V malzeme

CHROME
CrV
VANADIUM



6
PCS



KOD NO Code No	SET Set	İÇERİK Details	AĞIRLIK Weight	PAKET/KOLİ Package/Box	FİYAT Price
RTA0602	6 pcs	T10, T15, 20, T25, T30, T40	582 gr	1 / 12 adet	



T SAPLI LOKMA ANAHTARLAR

- Özel tasarım ergonomik sap
- Korozyona karşı parlak chrome kaplama
- Anahtarların kolay oturması için yuvarlatılmış uçlar
- Sıcak çekilmiş, sertleştirilmiş ve tavllanmış CR-V malzeme

KOD NO Code No	mm	L1 mm	L2 mm	AĞIRLIK Weight	PAKET/KOLİ Package/Box	FİYAT Price
RTS1006	6	260	200	202 gr	12 / 96 adet	
RTS1007	7	260	200	198 gr	12 / 96 adet	
RTS1011	11	260	200	260 gr	12 / 96 adet	
RTS1012	12	260	200	263 gr	12 / 96 adet	
RTS1013	13	260	200	269 gr	12 / 96 adet	



ÇAKI ALLEN ANAHTAR SETİ

- Paslanmaya karşı parlak chrome kaplı sertleştirilmiş chrome vanadium çeliği.
- Katlanır yapısı ile cepte taşınabilir.



KOD NO Code No	SET Set	İÇERİK Details	AĞIRLIK Weight	PAKET/KOLİ Package/Box	FİYAT Price
RCA0200	7pcs	2.5mm, 3mm, 4mm, 5mm, 6mm, 8mm, 10mm	374 gr	12 / 48 adet	



ÇAKI ALLEN ANAHTAR SETİ - TOPBAŞLI

- Paslanmaya karşı parlak chrome kaplı sertleştirilmiş chrome vanadium çeliği.
- Ulaşılması zor yerlerdeki köşe vidalar için.
- Katlanır yapısı ile cepte taşınabilir.



KOD NO Code No	SET Set	İÇERİK Details	AĞIRLIK Weight	PAKET/KOLİ Package/Box	FİYAT Price
RCT0210	7pcs	2.5mm, 3mm, 4mm, 5mm, 6mm, 8mm, 10mm	361 gr	12 / 48 adet	

T SAPLI ALLEN ANAHTARLAR

- Sıcak dövülmüş, sertleştirilmiş ve tavllanmış S2 malzeme

KOD NO Code No	ÖLÇÜ mm	PAKET/KOLİ Package/Box	FİYAT Price
RTA5020	2 mm	12 / 96 adet	
RTA5025	2.5 mm	12 / 96 adet	
RTA5030	3 mm	12 / 96 adet	
RTA5060	6 mm	12 / 96 adet	
RTA5080	8 mm	12 / 96 adet	



T SAPLI TORX ANAHTAR - DELİKSİZ

- Özel tasarım ergonomik sap
- Korozyona karşı parlak chrome kaplama
- Anahtarların kolay oturması için yuvarlatılmış uçlar
- Sıcak çekilmiş, sertleştirilmiş ve tavllanmış S2 malzeme

KOD NO Code No	mm	L1 mm	L2 mm	L3 mm	AĞIRLIK Weight	PAKET/KOLİ Package/Box	FİYAT Price
RTA7009	T9 x 100 mm	140	100	12	38 gr	12 / 96 adet	
RTA7010	T10 x 100 mm	140	100	12	38 gr	12 / 96 adet	
RTA7015	T15 x 100 mm	140	100	12	38 gr	12 / 96 adet	
RTA7025	T25 x 150 mm	200	150	20	107 gr	12 / 96 adet	
RTA7027	T27 x 150 mm	200	150	20	108 gr	12 / 96 adet	
RTA7040	T40 x 150 mm	200	150	20	110 gr	12 / 96 adet	

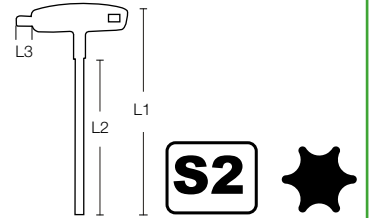

T SAPLI TORX ANAHTAR - DELİKLİ

- Özel tasarım ergonomik sap
- Korozyona karşı parlak chrome kaplama
- Anahtarların kolay oturması için yuvarlatılmış uçlar
- Sıcak çekilmiş, sertleştirilmiş ve tavllanmış S2 malzeme

KOD NO Code No	mm	L1 mm	L2 mm	L3 mm	AĞIRLIK Weight	PAKET/KOLİ Package/Box	FİYAT Price
RTA6009	T9 x 100 mm	140	100	12	38 gr	12 / 96 adet	
RTA6010	T10 x 100 mm	140	100	12	38 gr	12 / 96 adet	
RTA6027	T27 x 150 mm	200	150	20	107 gr	12 / 96 adet	

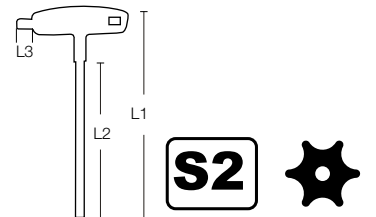



5
PCS



CHROME
CrV
VANADIUM



L ANAHTAR TAKIMI - XZN

- Korozyona karşı mat chrome kaplama
- Anahtarların kolay oturması için yuvarlatılmış uçlar
- İstenilen boyun kolay seçimini sağlayan klips
- Sertleştirilmiş kaliteli chrome vanadium malzeme

KOD NO Code No	SET Set	İÇERİK Details	AĞIRLIK Weight	PAKET/KOLİ Package/Box	FİYAT Price
ROT5000	5pcs	M5, M6, M8, M10, M12	302 gr	12 / 48 adet	

7
PCS



CHROME
CrV
VANADIUM



L TOPBAŞLI TORX ANAHTAR TAKIMI UZUN

- Korozyona karşı mat chrome kaplama
- Anahtarların kolay oturması için yuvarlatılmış uçlar
- İstenilen boyun kolay seçimini sağlayan klips
- Sertleştirilmiş kaliteli chrome vanadium malzeme
- Topbaşlı yada açılı kullanımı

KOD NO Code No	SET Set	İÇERİK Details	AĞIRLIK Weight	PAKET/KOLİ Package/Box	FİYAT Price
RTT7000	7pcs	T10, T15, T20, T25, T27, T30, T40	179 gr	12 / 48 adet	

7
PCS



CHROME
CrV
VANADIUM



L RIBE ANAHTAR TAKIMI UZUN

- Korozyona karşı mat chrome kaplama
- Anahtarların kolay oturması için yuvarlatılmış uçlar
- İstenilen boyun kolay seçimini sağlayan klips
- Sertleştirilmiş kaliteli chrome vanadium malzeme

KOD NO Code No	SET Set	İÇERİK Details	AĞIRLIK Weight	PAKET/KOLİ Package/Box	FİYAT Price
RRT7000	7pcs	M4, M5, M6, M7, M8, M9, M10	600 gr	12 / 48 adet	

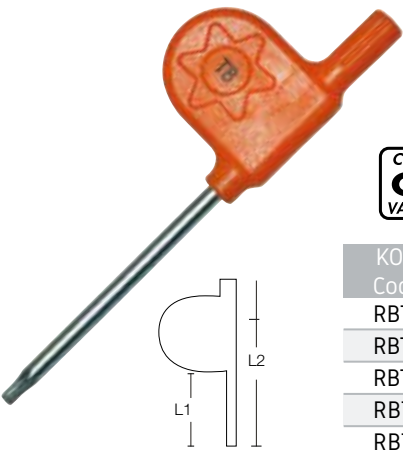

CHROME
CrV
VANADIUM



P SAPLI BAYRAK TORX ANAHTAR

- Karter vidaları için özel tasarım
- Korozyona karşı mat chrome kaplama
- Anahtarların kolay oturması için yuvarlatılmış uçlar
- İstenilen boyun kolay seçimini sağlayan klips
- Sertleştirilmiş kaliteli chrome vanadium malzeme

KOD NO Code No	İÇERİK Details	L1 mm	L2 mm	AĞIRLIK Weight	PAKET/KOLİ Package/Box	FİYAT Price
RBTOT05	T5	43	83	7 gr	24 / 480 adet	
RBTOT06	T6	43	83	7 gr	24 / 480 adet	
RBTOT08	T8	43	83	7 gr	24 / 480 adet	
RBTOT10	T10	43	83	9 gr	12 / 240 adet	
RBTOT15	T15	43	83	9 gr	12 / 144 adet	
RBTOT20	T20	43	83	10 gr	12 / 108 adet	

LOKMALAR



Güç ve Hassasiyet

- ◆ Bükülmeye ve kırılmaya karşı yüksek dayanıklılığa sahip Chrome Vanadium çeliğinden üretilmiştir.
- ◆ Hobi kullanımdan, zorlu koşullar altında, sanayinin aradığı en üst kalite değerlere uygundur.
- ◆ Civata başlarına kolay geçen profiller.
- ◆ Düşük imalat toleransları, anahtarların civata üzerine kusursuz oturmasını sağlar.

Ergonomi ve Geniş Ürün Gamı

- ◆ Pütürlü parlak yüzey avantajıyla yağlı ellerle bile güvenli kavrama.
- ◆ Keskin kenarları sıkıntısı 0'a indirilmiş ergonomik gövde tasarımı.
- ◆ Standart metrik ölçülerinde temini mümkün geniş portfolyo.
- ◆ Tek ya da setler veya modüller halinde temin edilebilir.



1/4" SERİSİ

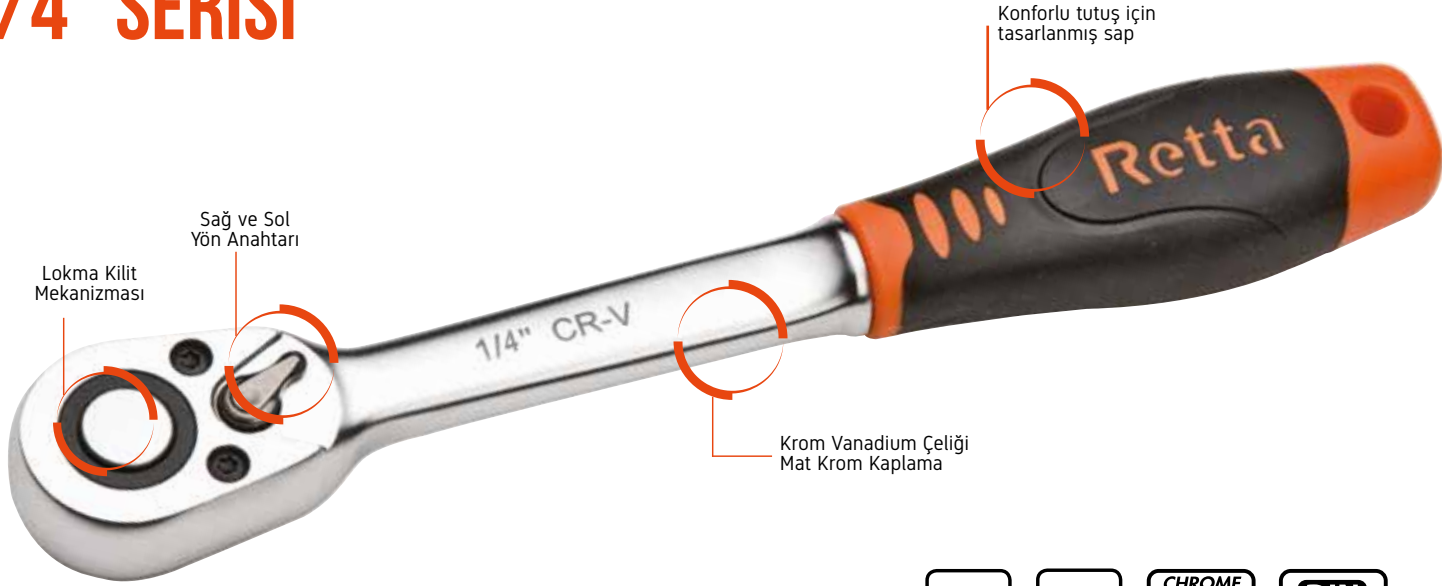

1/4"

**CHROME
CrV
VANADIUM**
**DIN
3122**

1/4" CIRCIR KOLU - MİNİ

- Parlak krom kaplı sertleştirilmiş kaliteli chrome vanadium çeliği.
- 1/4" lokma anahtarlar ve lokmalı bitsler ile kullanım için.
- 48 dişli hassas circir mekanizması.

KOD NO Code No	ÖLÇÜ mm	AĞIRLIK Weight	PAKET/KOLİ Package/Box	FIYAT Price
RCK0207	100 mm	95 gr	20 / 60 adet	



1/4" CIRCIR KOLU

- Parlak krom kaplı sertleştirilmiş kaliteli chrome vanadium çeliği.
- 1/4" lokma anahtarlar ve lokmalı bitsler ile kullanım için.
- 72 dişli hassas circir mekanizması.

KOD NO Code No	ÖLÇÜ mm	AĞIRLIK Weight	PAKET/KOLİ Package/Box	FIYAT Price
RCK0206	145mm	95 gr	10 / 60 adet	



1/4" CIRCIR KOLU

- Parlak krom kaplı sertleştirilmiş kaliteli chrome vanadium çeliği.
- 1/4" lokma anahtarlar ve lokmalı bitsler ile kullanım için.
- 48 dişli hassas circir mekanizması.

KOD NO Code No	ÖLÇÜ mm	AĞIRLIK Weight	PAKET/KOLİ Package/Box	FIYAT Price
RCK0209	140mm	126 gr	10 / 60 adet	



1/4" LOKMA ANAHTAR KISA - 6 KÖŞE

- Altı köşe civatalar için lokma anahtarlar.
- Parlak krom kaplı sertleştirilmiş kaliteli chrome vanadium çeliği.

KOD NO Code No	ÖLÇÜ mm	PAKET/KOLİ Package/Box	FIYAT Price
RTLO204	4 mm	15 / 1800 adet	
RTLO205	5 mm	15 / 1800 adet	
RTLO206	6 mm	15 / 1800 adet	
RTLO207	7 mm	15 / 1800 adet	
RTLO208	8 mm	15 / 1800 adet	
RTLO209	9 mm	15 / 1800 adet	
RTLO210	10 mm	15 / 1800 adet	
RTLO211	11 mm	15 / 1200 adet	
RTLO212	12 mm	15 / 1200 adet	
RTLO213	13 mm	15 / 900 adet	



1/4" LOKMA ANAHTAR UZUN - 6 KÖŞE

- Altı köşe civatalar için lokma anahtarlar.
- Parlak krom kaplı sertleştirilmiş kaliteli chrome vanadium çeliği.

KOD NO Code No	ÖLÇÜ mm	PAKET/KOLİ Package/Box	FIYAT Price
RTLO404	4 mm	15 / 900 adet	
RTLO405	5 mm	15 / 900 adet	
RTLO406	6 mm	15 / 900 adet	
RTLO407	7 mm	15 / 900 adet	
RTLO408	8 mm	15 / 900 adet	
RTLO409	9 mm	15 / 900 adet	
RTLO410	10 mm	15 / 720 adet	
RTLO411	11 mm	15 / 540 adet	
RTLO412	12 mm	15 / 540 adet	
RTLO413	13 mm	10 / 450 adet	



1/4" LOKMA ANAHTAR UZUN - 12 KÖŞE

- Oniki köşe civatalar için lokma anahtarlar.
- Parlak krom kaplı sertleştirilmiş kaliteli chrome vanadium çeliği.

KOD NO Code No	ÖLÇÜ mm	PAKET/KOLİ Package/Box	FIYAT Price
RJU1406	6 mm	15 / 900 adet	
RJU1407	7 mm	15 / 900 adet	
RJU1408	8 mm	15 / 900 adet	
RJU1410	10 mm	15 / 720 adet	
RJU1413	13 mm	15 / 450 adet	



1/4" İÇ TORX LOKMA ANAHTAR

- Torx başlı civatalar için.
- Parlak krom kaplı sertleştirilmiş kaliteli chrome vanadium çeliği.

KOD NO Code No	ÖLÇÜ mm	PAKET/KOLİ Package/Box	FIYAT Price
RTD1404	E4	15 / 1800 adet	
RTD1405	E5	15 / 1800 adet	
RTD1406	E6	15 / 1800 adet	
RTD1407	E7	15 / 1800 adet	
RTD1408	E8	15 / 1800 adet	
RTD1410	E10	15 / 1800 adet	
RTD1411	E11	15 / 120 adet	



1/4"

3/8"

1/4" - 3/8" LOKMA ADAPTÖR

- 1/4" lokma anahtarlar için kullanım.
- Parlak krom kaplı sertleştirilmiş kaliteli chrome vanadium çeliği.

KOD NO Code No	ÖLÇÜ mm	PAKET/KOLİ Package/Box	FIYAT Price
RAL1438	1/4" > 3/8"	24 / 300 adet	



1/4" UNIVERSAL MAFSAL

- 1/4" lokma anahtarlar için kullanım.
- Parlak krom kaplı sertleştirilmiş kaliteli chrome vanadium çeliği.

KOD NO Code No	ÖLÇÜ mm	PAKET/KOLİ Package/Box	FIYAT Price
RUM0114	30mm	15/ 750 adet	



1/4" T KOL

- 1/4" lokma anahtarlar için T kol.
- Parlak krom kaplı sertleştirilmiş kaliteli chrome vanadium çeliği.

KOD NO Code No	ÖLÇÜ mm	PAKET/KOLİ Package/Box	FIYAT Price
RTK1415	115 mm	50 / 200 adet	



1/4" UZATMA KOLU

- 1/4" lokma anahtarlar için T kol.
- Parlak krom kaplı sertleştirilmiş kaliteli chrome vanadium çeliği.

KOD NO Code No	ÖLÇÜ mm	PAKET/KOLİ Package/Box	FIYAT Price
RUK1407	75 mm	24 / 288 adet	
RUK1410	100 mm	24 / 288 adet	
RUK1415	150 mm	24 / 192 adet	



1/4" UZATMA KOLU FLEX

- 1/4" lokma anahtarlar için uzatma kolu flex.

KOD NO Code No	ÖLÇÜ mm	PAKET/KOLİ Package/Box	FIYAT Price
RYU0150	150 mm	15 / 300 adet	



1/4" MAFSALLI T SAPLI LOKMA

- 1/4" lokma anahtarlar için uzatma kolu flex.

KOD NO Code No	ÖLÇÜ mm	PAKET/KOLİ Package/Box	FIYAT Price
RFA0014	375 mm	10 / 50 adet	

1/4" LOKMA TORNAVIDA

- 1/4" lokma anahtarlar için tornavida.
- Parlak krom kaplı sertleştirilmiş kaliteli chrome vanadium çeliği.

KOD NO Code No	ÖLÇÜ mm	PAKET/KOLİ Package/Box	FİYAT Price
RTL0014	150 mm	10 / 200 adet	



1/4" LOKMALI TORX KISA - 6 KÖŞE

- Torx civata lokma anahtarlar için

KOD NO Code No	ÖLÇÜ mm	PAKET/KOLİ Package/Box	FİYAT Price
RTL0T10	T10	15 / 1800 adet	
RTL0T15	T15	15 / 1800 adet	
RTL0T20	T20	15 / 1800 adet	
RTL0T27	T27	15 / 1800 adet	
RTL0T30	T30	15 / 1800 adet	
RTL0T40	T40	15 / 1200 adet	



1/4" LOKMALI TORX KISA - 5 KÖŞE

- 5 Köşe civatalar için lokma anahtarlar.

KOD NO Code No	ÖLÇÜ mm	PAKET/KOLİ Package/Box	FİYAT Price
RTL0910	T10	15 / 1800 adet	
RTL0920	T20	15 / 1800 adet	
RTL0925	T25	15 / 1800 adet	
RTL0927	T27	15 / 1800 adet	
RTL0930	T30	15 / 1800 adet	
RTL0940	T40	15 / 1200 adet	



1/4" LOKMALI YILDIZ UÇ

- Yıldız civatalar için lokma anahtarlar.
- Parlak krom kaplı sertleştirilmiş kaliteli chrome vanadium çeliği.

KOD NO Code No	ÖLÇÜ mm	PAKET/KOLİ Package/Box	FİYAT Price
RPH1025	PH1	15 / 1800 adet	
RPH2025	PH2	15 / 1800 adet	
RPH3025	PH3	15 / 1800 adet	



1/4" LOKMALI ALLEN KISA

- 6 Köşe allen başlı civata lokma anahtarlar için

KOD NO Code No	ÖLÇÜ mm	PAKET/KOLİ Package/Box	FİYAT Price
RTA0030	3 mm	15 / 1800 adet	
RTA0040	4 mm	15 / 1800 adet	
RTA0050	5 mm	15 / 1800 adet	
RTA0060	6 mm	15 / 1800 adet	
RTA0070	7 mm	15 / 1800 adet	
RTA0010	10 mm	15 / 1200 adet	



1/4" LOKMALI İÇ TORX SET

- İÇERİK: E4, E5, E6, E7, E8, E10, E11
- Parlak krom kaplı sertleştirilmiş kaliteli chrome vanadium çeliği.

KOD NO Code No	İÇERİK Details	PAKET/KOLİ Package/Box	FİYAT Price
RTS0702	7 pcs	12 / 72 adet	



1/4" LOKMALI TORX SET

- İÇERİK: T10, T15, T20, T25, T27, T30, T40
- Parlak krom kaplı sertleştirilmiş kaliteli chrome vanadium çeliği.

KOD NO Code No	İÇERİK Details	PAKET/KOLİ Package/Box	FİYAT Price
RTL1040	7 pcs	12 / 72 adet	



1/4" LOKMALI DELİKLİ TORX SET - 5 KÖŞE

- İÇERİK: T10, T15, T20, T25, T27, T30, T40
- Parlak krom kaplı sertleştirilmiş kaliteli chrome vanadium çeliği.

KOD NO Code No	İÇERİK Details	PAKET/KOLİ Package/Box	FİYAT Price
RTL0704	7 pcs	12 / 72 adet	

1/4" LOKMA TAKIMI - 6 KÖŞE

- İÇERİK: 4, 5, 5.5, 6, 7, 8, 9, 10, 11, 12, 13 mm
- Cırcır Kol, Uzatma 100 mm, Mafsal, T Kol, Lokma Tornavida
- Gerilime dayanıklı sac kutu ambalaj.
- Lokmalar plastik tepsilerdeki yuvalarına sıralı yerleştirilmiştir.
- Cırcır kollar ergonomik olarak dizayn edilmiştir.
- Parlak krom kaplı sertleştirilmiş kaliteli chrome vanadium çeliği.

16
PCS



KOD NO Code No	İÇERİK Details	PAKET/KOLİ Package/Box	FİYAT Price
RLT1604	16 pcs	1 / 15 adet	

1/4" LOKMA TAKIMI - 6 KÖŞE

- İÇERİK: Cırcır Kolu, Uzatma 50-150 mm, Mafsal, T Kol,
- Lokma Tornavidası, Alyan: 1.25, 1.5, 2, 2.5, 3 mm
- ● 4, 4.5, 5, 5.5, 6, 7, 8, 9, 10, 11, 12, 13 mm
- ★ T8, T10, T15, T20, T25, T27, T30
- ● PH1, PH2 ● 5.5, 7 mm
- ● PZ1, PZ2 ● 4, 5, 6 mm

40
PCS



KOD NO Code No	İÇERİK Details	PAKET/KOLİ Package/Box	FİYAT Price
RLT4002	40 pcs	1 / 15 adet	

1/4" LOKMA TAKIMI - 6 KÖŞE

- İÇERİK: Cırcır Kolu, Uzatma 75-100 mm, Mafsal, T Kol, Lokma
- Tornavidası, Bits Adaptörü, Alyan: 1.5, 2, 2.5, 3, 4, 5, 6 mm
- ● K 4, 5, 6, 7, 8, 9, 10, 11, 12, 13 mm
- ★ T10, T15, T20, T25, T27, T30, T40
- ● U 6, 7, 8, 9, 10, 11, 12, 13 mm
- ● PH1, PH2, PH3 ● 4, 5.5, 6.5 mm

45
PCS



KOD NO Code No	İÇERİK Details	PAKET/KOLİ Package/Box	FİYAT Price
RLT4501	45 pcs	1 / 15 adet	

1/4" LOKMA TAKIMI UZUN - 6 KÖŞE

- İÇERİK: 4, 5, 6, 7, 8, 9, 10, 11, 13 mm , Lokma Tornavida
- Parlak krom kaplı sertleştirilmiş kaliteli chrome vanadium çeliği.

10
PCS



KOD NO Code No	İÇERİK Details	PAKET/KOLİ Package/Box	FİYAT Price
RLT1001	10 pcs	1 / 24 adet	



3/8" SERİSİ

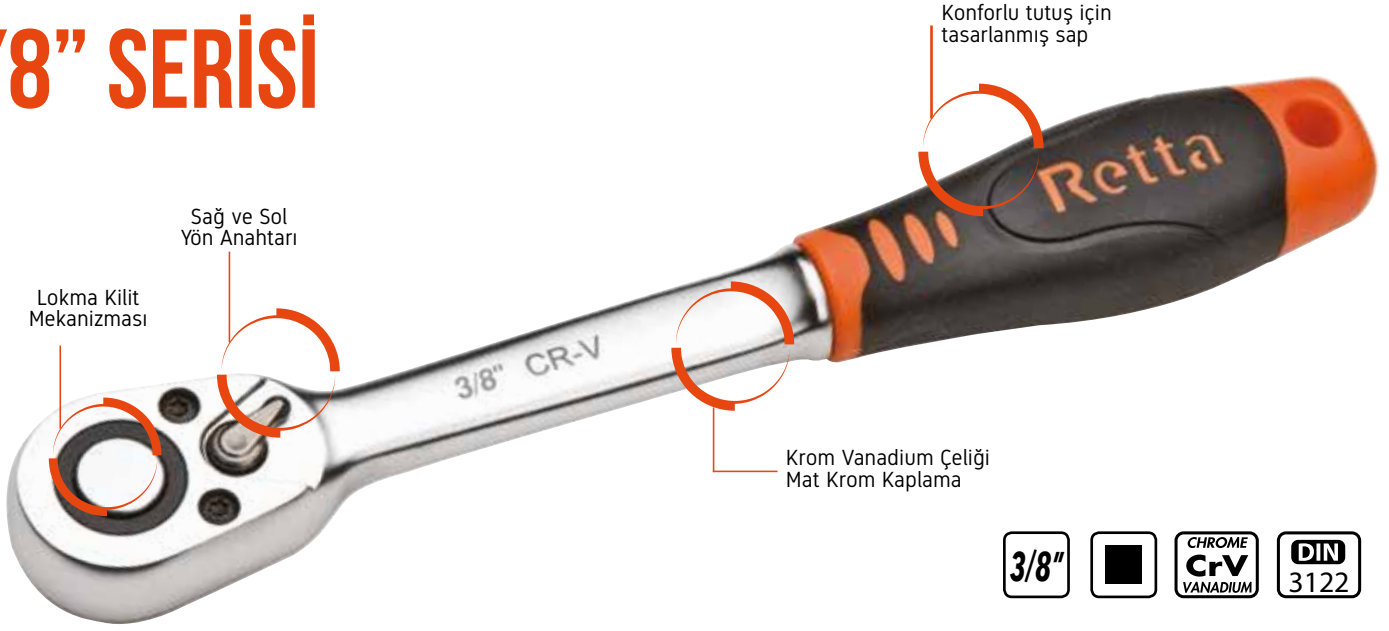

3/8"

CHROME
CrV
VANADIUMDIN
3122

3/8" CIRCIR KOLU

- Parlak krom kaplı sertleştirilmiş kaliteli chrome vanadium çeliği.
- 3/8" lokma anahtarlar ve lokmalı bitsler ile kullanım için.
- 72 dişli hassas circir mekanizması.

KOD NO Code No	ÖLÇÜ mm	AĞIRLIK Weight	PAKET/KOLİ Package/Box	FİYAT Price
RCK0306	200mm	278 gr	10 / 40 adet	



3/8" ASETAT SAPLI CIRCIR KOLU

- Parlak krom kaplı sertleştirilmiş kaliteli chrome vanadium çeliği.
- 3/8" lokma anahtarlar ve lokmalı bitsler ile kullanım için.
- 48 dişli hassas circir mekanizması.
- Asetat sap sayesinde yüksek kimyasal dayanımı.

KOD NO Code No	ÖLÇÜ mm	AĞIRLIK Weight	PAKET/KOLİ Package/Box	FİYAT Price
RCK0310	197 mm	258 gr	10 / 40 adet	



3/8" CIRCIR KOLU

- Parlak krom kaplı sertleştirilmiş kaliteli chrome vanadium çeliği.
- 3/8" lokma anahtarlar ve lokmalı bitsler ile kullanım için.
- 48 dişli hassas circir mekanizması.

KOD NO Code No	ÖLÇÜ mm	AĞIRLIK Weight	PAKET/KOLİ Package/Box	FİYAT Price
RCK0309	197mm	280 gr	10 / 40 adet	



3/8" LOKMA ANAHTAR UZUN - 6 KÖŞE

- Altı köşe civatalar için lokma anahtarlar.
- Parlak krom kaplı sertleştirilmiş kaliteli chrome vanadium çeliği.

KOD NO Code No	ÖLÇÜ mm	PAKET/KOLİ Package/Box	FIYAT Price
RTL0308	8 mm	15 / 300 adet	
RTL0310	10 mm	15 / 300 adet	
RTL0311	11 mm	15 / 300 adet	
RTL0312	12 mm	15 / 300 adet	
RTL0313	13 mm	15 / 300 adet	



3/8" LOKMA ANAHTAR UZUN - 12 KÖŞE

- Oniki köşe civatalar için lokma anahtarlar.
- Parlak krom kaplı sertleştirilmiş kaliteli chrome vanadium çeliği.

KOD NO Code No	ÖLÇÜ mm	PAKET/KOLİ Package/Box	FIYAT Price
RYU3808	8 mm	15 / 300 adet	
RYU3810	10 mm	15 / 300 adet	
RYU3811	11 mm	15 / 300 adet	
RYU3812	12 mm	15 / 300 adet	
RYU3813	13 mm	15 / 300 adet	



3/8" LOKMA ANAHTAR KISA - 6 KÖŞE

KOD NO Code No	ÖLÇÜ mm	PAKET/KOLİ Package/Box	FIYAT Price
RTL3806	6 mm	15 / 400 adet	
RTL3807	7 mm	15 / 400 adet	
RTL3808	8 mm	15 / 400 adet	
RTL3809	9 mm	15 / 400 adet	
RTL3810	10 mm	15 / 400 adet	
RTL3811	11 mm	15 / 400 adet	
RTL3812	12 mm	15 / 400 adet	
RTL3813	13 mm	15 / 400 adet	
RTL3814	14 mm	15 / 400 adet	
RTL3815	15 mm	15 / 400 adet	
RTL3816	16 mm	15 / 400 adet	
RTL3817	17 mm	15 / 200 adet	
RTL3818	18 mm	15 / 200 adet	
RTL3819	19 mm	15 / 200 adet	
RTL3820	20 mm	15 / 200 adet	
RTL3821	21 mm	15 / 100 adet	
RTL3822	22 mm	15 / 100 adet	
RTL3824	24 mm	15 / 100 adet	

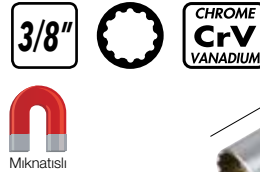

KISA

3/8" BUJÜ ANAHTARI - 12 KÖŞE

- Mat krom kaplı sertleştirilmiş kaliteli chrome vanadium çeliği.
- Araba motorlarındaki bujiler için lokma anahtar.

KOD NO Code No	ÖLÇÜ mm	PAKET/KOLİ Package/Box	FIYAT Price
RBA3809	90 mm	25 / 300 adet	



UZUN

3/8" BUJÜ ANAHTARI - 12 KÖŞE

- Mat krom kaplı sertleştirilmiş kaliteli chrome vanadium çeliği.
- Araba motorlarındaki bujiler için lokma anahtar.

KOD NO Code No	ÖLÇÜ mm	PAKET/KOLİ Package/Box	FIYAT Price
RBA3825	250 mm	25 / 300 adet	



3/8\"/>

- Mat krom kaplı sertleştirilmiş kaliteli chrome vanadium çeliđi.
- Araba motorlarındaki bujiler için lokma anahtar.

KOD NO Code No	ÖLÇÜ mm	PAKET/KOLİ Package/Box	FIYAT Price
RAL3814	3/8\"/>		



3/8\"/>

- Mat krom kaplı sertleştirilmiş kaliteli chrome vanadium çeliđi.
- Araba motorlarındaki bujiler için lokma anahtar.

KOD NO Code No	ÖLÇÜ mm	PAKET/KOLİ Package/Box	FIYAT Price
RAL3812	3/8\"/>		

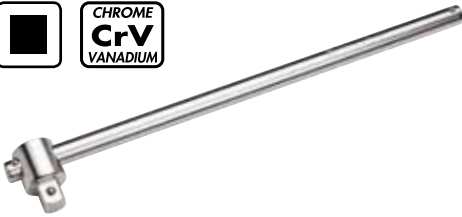

3/8\"/>

- Parlak krom kaplı sertleştirilmiş kaliteli chrome vanadium çeliđi.
- 3/8\"/>

KOD NO Code No	ÖLÇÜ mm	PAKET/KOLİ Package/Box	FIYAT Price
RTK3820	200 mm	24 / 96 adet	



3/8\"/>

- Parlak krom kaplı sertleştirilmiş kaliteli chrome vanadium çeliđi.
- 3/8\"/>

KOD NO Code No	ÖLÇÜ mm	PAKET/KOLİ Package/Box	FIYAT Price
RFA0038	420 mm	5 / 50 adet	



3/8\"/>

- Parlak krom kaplı sertleştirilmiş kaliteli chrome vanadium çeliđi.
- 3/8\"/>

KOD NO Code No	ÖLÇÜ mm	PAKET/KOLİ Package/Box	FIYAT Price
RUK3807	75 mm	25 / 100 adet	
RUK3815	150 mm	25 / 100 adet	
RUK3825	250 mm	24 / 48 adet	



3/8\"/>

- Parlak krom kaplı sertleştirilmiş kaliteli chrome vanadium çeliđi.
- 1/4\"/>

KOD NO Code No	ÖLÇÜ mm	PAKET/KOLİ Package/Box	FIYAT Price
RUM0138	58 mm	15 / 300 adet	

3/8" LOKMA TAKIMI - 6 KÖŞE

 24
PCS

- Cırcır Kol, Uzatma 75-150 mm, Mafsal, Buji Lokması: 16 mm, 21 mm
- ● 6, 7, 8, 9, 10, 11, 12, 13, 14, 15, 16, 17, 18, 19, 20, 21, 22, 24 mm

3/8"

 CHROME
CrV
VANADIUM

KOD NO Code No	İÇERİK Details	PAKET/KOLİ Package/Box	FİYAT Price
RLT2402	24 pcs	1 / 8 adet	

3/8" GO-THROUGH LOKMA TAKIMI

 15
PCS

- Cırcır Kol, Uzatma 80 mm, 3/8" adaptör
- ● 10, 11, 12, 13, 14, 15, 16, 17, 18, 19, 21, 22 mm



KOD NO Code No	İÇERİK Details	PAKET/KOLİ Package/Box	FİYAT Price
RGL0015	15 pcs	1 / 8 adet	



3/8"

 CHROME
CrV
VANADIUM



1/2" SERİSİ



1/2"

CHROME
CrV
VANADIUMDIN
3122

1/2" CIRCIR KOLU

- Parlak krom kaplı sertleştirilmiş kaliteli chrome vanadium çeliği.
- 1/2" lokma anahtarlar ve lokmalı bitsler ile kullanım için.
- 72 dişli hassas circir mekanizması.

KOD NO Code No	ÖLÇÜ mm	AĞIRLIK Weight	PAKET/KOLİ Package/Box	FİYAT Price
RCK0406	255mm	532 gr	10 / 30 adet	



1/2" ASETAT SAPLI CIRCIR KOLU

- Parlak krom kaplı sertleştirilmiş kaliteli chrome vanadium çeliği.
- 1/2" lokma anahtarlar ve lokmalı bitsler ile kullanım için.
- 48 dişli hassas circir mekanizması.
- Asetat sap sayesinde yüksek kimyasal dayanımı.

KOD NO Code No	ÖLÇÜ mm	AĞIRLIK Weight	PAKET/KOLİ Package/Box	FİYAT Price
RCK0410	255 mm	533 gr	10 / 72 adet	



1/2" CIRCIR KOLU

- Parlak krom kaplı sertleştirilmiş kaliteli chrome vanadium çeliği.
- 1/2" lokma anahtarlar ve lokmalı bitsler ile kullanım için.
- 48 dişli hassas circir mekanizması.

KOD NO Code No	ÖLÇÜ mm	AĞIRLIK Weight	PAKET/KOLİ Package/Box	FİYAT Price
RCK0409	255mm	532 gr	10 / 30 adet	

1/2" CIRCIR KOLU MAFSALLI

- Parlak krom kaplı sertleştirilmiş kaliteli chrome vanadium çeliği.
- 1/2" lokma anahtarlar ve lokmalı bitsler ile kullanım için.
- 48 dişli hassas circir mekanizması.

KOD NO Code No	ÖLÇÜ mm	AĞIRLIK Weight	PAKET/KOLİ Package/Box	FIYAT Price
RCK0109	260 mm	653 gr	5 / 20 adet	



1/2" CIRCIR KOLU UZATMALI

- Parlak krom kaplı sertleştirilmiş kaliteli chrome vanadium çeliği.
- 1/2" lokma anahtarlar ve lokmalı bitsler ile kullanım için.
- 72 dişli hassas circir mekanizması.

KOD NO Code No	ÖLÇÜ mm	AĞIRLIK Weight	PAKET/KOLİ Package/Box	FIYAT Price
RCK0509	285-425 mm	945 gr	5 / 20 adet	



1/2" CIRCIR KOLU DÖNERLİ

- Parlak krom kaplı sertleştirilmiş kaliteli chrome vanadium çeliği.
- 1/2" lokma anahtarlar ve lokmalı bitsler ile kullanım için.
- 72 dişli hassas circir mekanizması.

KOD NO Code No	ÖLÇÜ mm	AĞIRLIK Weight	PAKET/KOLİ Package/Box	FIYAT Price
RCK0609	255 mm	650 gr	5 / 20 adet	



1/2" CIRCIR KOLU - KARESİ ÇIKAN

- Parlak krom kaplı sertleştirilmiş kaliteli chrome vanadium çeliği.
- 1/2" lokma anahtarlar ve lokmalı bitsler ile kullanım için.
- 72 dişli hassas circir mekanizması.

KOD NO Code No	ÖLÇÜ mm	AĞIRLIK Weight	PAKET/KOLİ Package/Box	FIYAT Price
RCK0709	255 mm	478 gr	10 adet	





1/2"

CHROME
CrV
VANADIUMDIN
3124

1/2" LOKMA ANAHTARLAR KISA - 6 KÖŞE

- Altı köşe civatalar için lokma anahtarlar.
- Parlak krom kaplı sertleştirilmiş kaliteli chrome vanadium çeliği.

KOD NO Code No	ÖLÇÜ mm	PAKET/KOLİ Package/Box	FIYAT Price
RTL0108	8 mm	10 / 400 adet	
RTL0109	9 mm	10 / 400 adet	
RTL0110	10 mm	10 / 400 adet	
RTL0111	11 mm	10 / 400 adet	
RTL0112	12 mm	10 / 400 adet	
RTL0113	13 mm	10 / 400 adet	
RTL0114	14 mm	10 / 400 adet	
RTL0115	15 mm	10 / 400 adet	
RTL0116	16 mm	10 / 400 adet	
RTL0117	17 mm	10 / 400 adet	
RTL0118	18 mm	10 / 400 adet	
RTL0119	19 mm	10 / 200 adet	
RTL0120	20 mm	10 / 200 adet	
RTL0121	21 mm	10 / 200 adet	
RTL0122	22 mm	10 / 200 adet	
RTL0123	23 mm	10 / 100 adet	
RTL0124	24 mm	10 / 100 adet	
RTL0125	25 mm	10 / 100 adet	
RTL0126	26 mm	10 / 100 adet	
RTL0127	27 mm	10 / 100 adet	
RTL0128	28 mm	10 / 100 adet	
RTL0129	29 mm	10 / 100 adet	
RTL0130	30 mm	10 / 100 adet	
RTL0132	32 mm	10 / 100 adet	

1/2"

CHROME
CrV
VANADIUMDIN
3124

1/2" LOKMA ANAHTARLAR UZUN - 6 KÖŞE

- Altı köşe civatalar için lokma anahtarlar.
- Parlak krom kaplı sertleştirilmiş kaliteli chrome vanadium çeliği.

KOD NO Code No	ÖLÇÜ mm	PAKET/KOLİ Package/Box	FIYAT Price
RTL1208	8 mm	10 / 200 adet	
RTL1210	10 mm	10 / 200 adet	
RTL1211	11 mm	10 / 200 adet	
RTL1212	12 mm	10 / 200 adet	
RTL1213	13 mm	10 / 200 adet	
RTL1214	14 mm	10 / 200 adet	
RTL1215	15 mm	10 / 200 adet	
RTL1216	16 mm	10 / 200 adet	
RTL1217	17 mm	10 / 150 adet	
RTL1218	18 mm	10 / 150 adet	
RTL1219	19 mm	10 / 150 adet	
RTL1220	20 mm	10 / 100 adet	
RTL1221	21 mm	10 / 100 adet	
RTL1222	22 mm	10 / 100 adet	
RTL1224	24 mm	10 / 100 adet	
RTL1227	27 mm	10 / 80 adet	
RTL1230	30 mm	10 / 50 adet	
RTL1232	32 mm	10 / 50 adet	

1/2" LOKMA ANAHTARLAR KISA - 12 KÖŞE

- Oniki köşe civatalar için lokma anahtarlar.
- Parlak krom kaplı sertleştirilmiş kaliteli chrome vanadium çeliği.



KOD NO Code No	ÖLÇÜ mm	PAKET/KOLİ Package/Box	FIYAT Price
RYL1208	8 mm	10 / 400 adet	
RYL1209	9 mm	10 / 400 adet	
RYL1210	10 mm	10 / 400 adet	
RYL1211	11 mm	10 / 400 adet	
RYL1212	12 mm	10 / 400 adet	
RYL1213	13 mm	10 / 400 adet	
RYL1214	14 mm	10 / 400 adet	
RYL1215	15 mm	10 / 400 adet	
RYL1216	16 mm	10 / 400 adet	
RYL1217	17 mm	10 / 400 adet	
RYL1218	18 mm	10 / 400 adet	
RYL1219	19 mm	10 / 200 adet	
RYL1221	21 mm	10 / 200 adet	
RYL1222	22 mm	10 / 200 adet	
RYL1223	23 mm	10 / 100 adet	
RYL1224	24 mm	10 / 100 adet	
RYL1225	25 mm	10 / 100 adet	
RYL1226	26 mm	10 / 100 adet	
RYL1227	27 mm	10 / 100 adet	
RYL1228	28 mm	10 / 100 adet	
RYL1229	29 mm	10 / 100 adet	
RYL1230	30 mm	10 / 100 adet	
RYL1232	32 mm	10 / 100 adet	



1/2" LOKMA ANAHTARLAR UZUN - 12 KÖŞE

- Oniki köşe civatalar için lokma anahtarlar.
- Parlak krom kaplı sertleştirilmiş kaliteli chrome vanadium çeliği.



KOD NO Code No	ÖLÇÜ mm	PAKET/KOLİ Package/Box	FIYAT Price
RYU1208	8 mm	10 / 200 adet	
RYU1210	10 mm	10 / 200 adet	
RYU1211	11 mm	10 / 200 adet	
RYU1212	12 mm	10 / 200 adet	
RYU1213	13 mm	10 / 200 adet	
RYU1214	14 mm	10 / 200 adet	
RYU1215	15 mm	10 / 200 adet	
RYU1216	16 mm	10 / 200 adet	
RYU1217	17 mm	10 / 150 adet	
RYU1218	18 mm	10 / 150 adet	
RYU1219	19 mm	10 / 150 adet	
RYU1220	20 mm	10 / 100 adet	
RYU1221	21 mm	10 / 100 adet	
RYU1222	22 mm	10 / 100 adet	
RYU1224	24 mm	10 / 100 adet	
RYU1227	27 mm	10 / 80 adet	
RYU1230	30 mm	10 / 50 adet	
RYU1232	32 mm	10 / 50 adet	





1/2" İÇ TORX ANAHTARLAR KISA

- Torx başlı civatalar için tasarlanmıştır.
- Parlak krom kaplı sertleştirilmiş kaliteli chrome vanadium çeliği.

KOD NO Code No	ÖLÇÜ mm	PAKET/KOLİ Package/Box	FIYAT Price
RTD1208	E8	10 / 400 adet	
RTD1210	E10	10 / 400 adet	
RTD1212	E12	10 / 400 adet	
RTD1214	E14	10 / 400 adet	
RTD1216	E16	10 / 400 adet	
RTD1218	E18	10 / 300 adet	
RTD1220	E20	10 / 300 adet	
RTD1222	E22	10 / 200 adet	
RTD1224	E24	10 / 200 adet	



1/2" İÇ TORX ANAHTARLAR UZUN

- Torx başlı civatalar için tasarlanmıştır.
- Parlak krom kaplı sertleştirilmiş kaliteli chrome vanadium çeliği.

KOD NO Code No	ÖLÇÜ mm	PAKET/KOLİ Package/Box	FIYAT Price
RTD0208	E8	10 / 400 adet	
RTD0210	E10	10 / 400 adet	
RTD0212	E12	10 / 400 adet	
RTD0214	E14	10 / 400 adet	
RTD0216	E16	10 / 400 adet	
RTD0218	E18	10 / 300 adet	
RTD0220	E20	10 / 300 adet	
RTD0222	E22	10 / 200 adet	
RTD0224	E24	10 / 200 adet	



1/2" BUJİ ANAHTARLARI - 6 KÖŞE

KOD NO Code No	ÖLÇÜ mm	PAKET/KOLİ Package/Box	FIYAT Price
RBA0116	16 mm	10 / 240 adet	
RBA0121	21 mm	10 / 160 adet	



1/2" UNIVERSAL MAFSAL

KOD NO Code No	ÖLÇÜ mm	PAKET/KOLİ Package/Box	FIYAT Price
RUM0112	79 mm	10 / 160 adet	



1/2" - 3/4" LOKMA ADAPTÖR

- 1/2" lokma anahtarlar için kullanım.
- Parlak krom kaplı sertleştirilmiş kaliteli chrome vanadium çeliği.

KOD NO Code No	ÖLÇÜ mm	PAKET/KOLİ Package/Box	FIYAT Price
RAL1234	1/2">3/4"	12 / 96 adet	



1/2" - 3/8" LOKMA ADAPTÖR

- 1/2" lokma anahtarlar için kullanım.
- Parlak krom kaplı sertleştirilmiş kaliteli chrome vanadium çeliği.

KOD NO Code No	ÖLÇÜ mm	PAKET/KOLİ Package/Box	FIYAT Price
RAL1238	1/2">3/8"	12 / 96 adet	

1/2" UZATMA KOL

- Parlak krom kaplı sertleştirilmiş kaliteli chrome vanadium çeliği.
- 1/2" lokma anahtarlar için uzatma kol

KOD NO Code No	ÖLÇÜ mm	AĞIRLIK Weight	PAKET/KOLİ Package/Box	FİYAT Price
RUK1207	75 mm	149 gr	24 / 144 adet	
RUK1212	125 mm	185 gr	24 / 96 adet	
RUK1225	250 mm	359 gr	12 / 48 adet	
RUK1240	400 mm	523 gr	12 / 48 adet	

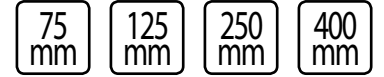

1/2" UZATMA KOL TOPBAŞLI

- Parlak krom kaplı sertleştirilmiş kaliteli chrome vanadium çeliği.
- 1/2" lokma anahtarlar için uzatma kol

KOD NO Code No	ÖLÇÜ mm	AĞIRLIK Weight	PAKET/KOLİ Package/Box	FİYAT Price
RUT1207	75 mm	130 gr	24 / 144 adet	
RUT1212	125 mm	190 gr	24 / 96 adet	
RUT1225	250 mm	339 gr	12 / 48 adet	

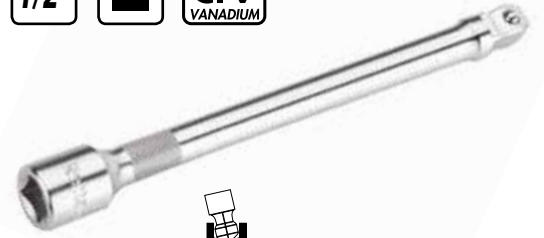

1/2" T KOL

- Parlak krom kaplı sertleştirilmiş kaliteli chrome vanadium çeliği.
- 1/2" lokma anahtarlar ve lokmalı bitsler için T kol.

KOD NO Code No	ÖLÇÜ mm	AĞIRLIK Weight	PAKET/KOLİ Package/Box	FİYAT Price
RTK1225	250 mm	374 gr	12 / 48 adet	
RTK1235	300 mm	431 gr	10 / 48 adet	

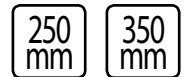
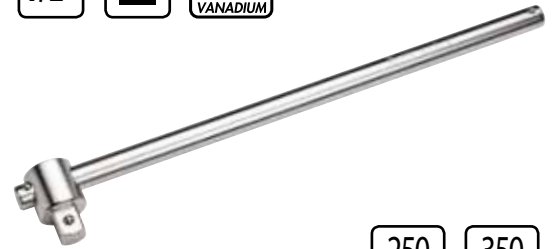

1/2" L KOL

- Parlak krom kaplı sertleştirilmiş kaliteli chrome vanadium çeliği.
- 1/2" lokma anahtarlar ve lokmalı bitsler için L kol.

KOD NO Code No	ÖLÇÜ mm	AĞIRLIK Weight	PAKET/KOLİ Package/Box	FİYAT Price
RLU0250	250 mm	385 gr	10 / 40 adet	





30 mm 1/2"



1/2" LOKMALI ALLEN UÇ KISA

- Altı köşe civatalar için lokmalı allen anahtarlar.
- Parlak krom kaplı sertleştirilmiş kaliteli chrome vanadium çeliği.

KOD NO Code No	ÖLÇÜ mm		PAKET/KOLİ Package/Box	FIYAT Price
RAL5004	4 mm	30 mm	10 / 240 adet	
RAL5005	5 mm	30 mm	10 / 240 adet	
RAL5006	6 mm	30 mm	10 / 240 adet	
RAL5007	7 mm	30 mm	10 / 240 adet	
RAL5008	8 mm	30 mm	10 / 240 adet	
RAL5009	9 mm	30 mm	10 / 240 adet	
RAL5010	10 mm	30 mm	10 / 240 adet	
RAL5012	12 mm	30 mm	10 / 240 adet	
RAL5014	14 mm	30 mm	10 / 240 adet	
RAL5017	17 mm	30 mm	10 / 240 adet	
RAL5019	19 mm	30 mm	10 / 240 adet	

100 mm 1/2" CHROME CrV VANADIUM



1/2" LOKMALI ALLEN UÇ UZUN

- Altı köşe civatalar için lokmalı allen anahtarlar.
- Parlak krom kaplı sertleştirilmiş kaliteli chrome vanadium çeliği.

KOD NO Code No	ÖLÇÜ mm		PAKET/KOLİ Package/Box	FIYAT Price
RAL1004	4 mm	100 mm	10 / 240 adet	
RAL1005	5 mm	100 mm	10 / 240 adet	
RAL1006	6 mm	100 mm	10 / 240 adet	
RAL1007	7 mm	100 mm	10 / 240 adet	
RAL1008	8 mm	100 mm	10 / 240 adet	
RAL1009	9 mm	100 mm	10 / 240 adet	
RAL1010	10 mm	100 mm	10 / 240 adet	
RAL1012	12 mm	100 mm	10 / 240 adet	
RAL1014	14 mm	100 mm	10 / 240 adet	
RAL1017	17 mm	100 mm	10 / 240 adet	
RAL1019	19 mm	100 mm	10 / 240 adet	

30 mm 1/2" CHROME CrV VANADIUM



1/2" LOKMALI TORX UÇ KISA - 6 KÖŞE

- Altı köşeli torx için bits uçlar.
- Kumlanmış, sertleştirilmiş kaliteli chrome vanadium çeliğinden bitsler.

KOD NO Code No	ÖLÇÜ mm		PAKET/KOLİ Package/Box	FIYAT Price
RTL5020	T20	30 mm	10 / 240 adet	
RTL5025	T25	30 mm	10 / 240 adet	
RTL5027	T27	30 mm	10 / 240 adet	
RTL5030	T30	30 mm	10 / 240 adet	
RTL5035	T35	30 mm	10 / 240 adet	
RTL5040	T40	30 mm	10 / 240 adet	
RTL5045	T45	30 mm	10 / 240 adet	
RTL5050	T50	30 mm	10 / 120 adet	
RTL5055	T55	30 mm	10 / 120 adet	
RTL5060	T60	30 mm	10 / 120 adet	
RTL5070	T70	30 mm	10 / 120 adet	

100 mm 1/2" CHROME CrV VANADIUM



1/2" LOKMALI TORX UÇ UZUN- 6 KÖŞE

- Altı köşeli torx için bits uçlar.
- Kumlanmış, sertleştirilmiş kaliteli chrome vanadium çeliğinden bitsler.

KOD NO Code No	ÖLÇÜ mm		PAKET/KOLİ Package/Box	FIYAT Price
RTL0520	T20	100 mm	10 / 240 adet	
RTL0525	T25	100 mm	10 / 240 adet	
RTL0527	T27	100 mm	10 / 240 adet	
RTL0530	T30	100 mm	10 / 240 adet	
RTL0535	T35	100 mm	10 / 240 adet	
RTL0540	T40	100 mm	10 / 240 adet	
RTL0545	T45	100 mm	10 / 240 adet	
RTL0550	T50	100 mm	10 / 240 adet	
RTL0555	T55	100 mm	10 / 240 adet	
RTL0560	T60	100 mm	10 / 240 adet	
RTL0570	T70	100 mm	10 / 240 adet	



1/2" LOKMALI TORX UÇ KISA - 12 KÖŞE

- Oniki köşeli torx için bits uçlar.
- Kumlanmış, sertleştirilmiş kaliteli chrome vanadium çeliğinden bitsler.

KOD NO Code No	ÖLÇÜ mm	PAKET/KOLİ Package/Box	FIYAT Price
RTL5008	M8 30 mm	10 / 200 adet	
RTL5010	M10 30 mm	10 / 200 adet	
RTL5012	M12 30 mm	10 / 200 adet	
RTL5014	M14 30 mm	10 / 200 adet	
RTL5016	M16 30 mm	10 / 200 adet	
RTL5018	M18 30 mm	10 / 200 adet	



1/2" LOKMALI TORX UÇ UZUN - 12 KÖŞE

- Oniki köşeli torx için bits uçlar.
- Kumlanmış, sertleştirilmiş kaliteli chrome vanadium çeliğinden bitsler.

KOD NO Code No	ÖLÇÜ mm	PAKET/KOLİ Package/Box	FIYAT Price
RTL0708	M8 100 mm	10 / 200 adet	
RTL0710	M10 100 mm	10 / 200 adet	
RTL0712	M12 100 mm	10 / 200 adet	
RTL0714	M14 100 mm	10 / 200 adet	
RTL0716	M16 100 mm	10 / 200 adet	
RTL0718	M18 100 mm	10 / 200 adet	



1/2" LOKMALI RİBE UÇ UZUN

- Altı köşeli ribe için bits uçlar.
- Kumlanmış, sertleştirilmiş kaliteli chrome vanadium çeliğinden bitsler.

KOD NO Code No	ÖLÇÜ mm	PAKET/KOLİ Package/Box	FIYAT Price
RTL0605	M5 100 mm	10 / 200 adet	
RTL0606	M6 100 mm	10 / 200 adet	
RTL0607	M7 100 mm	10 / 200 adet	
RTL0608	M8 100 mm	10 / 200 adet	
RTL0609	M9 100 mm	10 / 200 adet	
RTL0610	M10 100 mm	10 / 200 adet	
RTL0614	M14 100 mm	10 / 100 adet	
RTL0616	M16 100 mm	10 / 100 adet	



1/2" LOKMALI TORX UÇ DELİKLİ - 12 KÖŞE

- Oniki köşeli torx için bits uçlar.
- Kumlanmış, sertleştirilmiş kaliteli chrome vanadium çeliğinden bitsler.

KOD NO Code No	ÖLÇÜ mm	PAKET/KOLİ Package/Box	FIYAT Price
RTL5516	M16 50 mm	10 / 240 adet	
RTL1016	M16 100 mm	10 / 240 adet	



1/2"

1/4"

1/2"

CHROME
CrV
VANADIUM

1/2" - 1/4" BITS ADAPTÖR

- Parlak krom kaplı sertleştirilmiş kaliteli chrome vanadium çeliği.
- 1/4" bits uçlar için kullanım.

KOD NO Code No	ÖLÇÜ mm	AĞIRLIK Weight	PAKET/KOLİ Package/Box	FIYAT Price
RBA1406	1/2">1/4"	49 gr	24 / 300 adet	



1/2"

10
mm

1/2"

CHROME
CrV
VANADIUM

1/2" - 10MM BITS ADAPTÖR

- Parlak krom kaplı sertleştirilmiş kaliteli chrome vanadium çeliği.
- 1/4" bits uçlar için kullanım.

KOD NO Code No	ÖLÇÜ mm	AĞIRLIK Weight	PAKET/KOLİ Package/Box	FIYAT Price
RBA1200	1/2">10mm	49 gr	10 adet	

7
PCS

1/2" İÇ TORX LOKMA TAKIMI

- Parlak krom kaplı sertleştirilmiş kaliteli chrome vanadium çeliği.
- Klipsli metal ray üzerinde.
- E10, E12, E14, E16, E18, E20, E24

KOD NO Code No	İÇERİK	AĞIRLIK Weight	PAKET/KOLİ Package/Box	FIYAT Price
RTS0703	7 pcs	515 gr	5 adet	

1/2"

CHROME
CrV
VANADIUM

1/2" MAFSALLI T SAPLI LOKMA ADAPTÖR

- Parlak krom kaplı sertleştirilmiş kaliteli chrome vanadium çeliği.
- 1/2" lokma anahtarlar ve lokmalı bitslerle kullanım için.

KOD NO Code No	ÖLÇÜ mm	AĞIRLIK Weight	PAKET/KOLİ Package/Box	FIYAT Price
RFA0012	500 mm	640 gr	5 / 20 adet	

T SAPLI FLEX LOKMA ANAHTARLAR

- Parlak krom kaplı sertleştirilmiş kaliteli chrome vanadium çeliği.
- Altı köşe civatalar için lokma anahtarlar.

KOD NO Code No	ÖLÇÜ mm		AĞIRLIK Weight	PAKET/KOLİ Package/Box	FİYAT Price
RFL0645	6 mm	400 mm	172 gr	6 / 50 adet	
RFL0745	7 mm	400 mm	168 gr	10 / 50 adet	
RFL0845	8 mm	400 mm	171 gr	10 / 50 adet	
RFL1045	10 mm	400 mm	280 gr	10 / 50 adet	
RFL1145	11 mm	400 mm	290 gr	5 / 50 adet	
RFL1245	12 mm	400 mm	285 gr	6 / 50 adet	
RFL1345	13 mm	400 mm	391 gr	5 / 50 adet	
RFL1445	14 mm	400 mm	392 gr	5 / 50 adet	
RFL1745	17 mm	400 mm	600 gr	5 / 50 adet	
RFL1945	19 mm	400 mm	895 gr	5 / 50 adet	

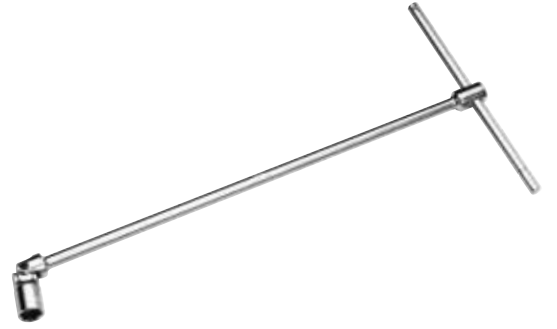

1/2"



CHROME
CrV
VANADIUM

T SAPLI FLEX BUJİ ANAHTARLAR

- Araba motorlarındaki bujiler için lokma anahtarlar.
- Çıkarma esnasında bujileri tutmaya yarayan plastik tutucu conta.
- Parlak chrome kaplı sertleştirilmiş kaliteli chrome vanadium çelik.

KOD NO Code No	ÖLÇÜ mm		AĞIRLIK Weight	PAKET/KOLİ Package/Box	FİYAT Price
RBA1216	16 mm	475 mm	608 gr	6 / 20 adet	
RBA1221	21 mm	475 mm	898 gr	5 / 20 adet	



1/2"



CHROME
CrV
VANADIUM



T SAPLI LOKMA ANAHTARLAR

- Parlak krom kaplı sertleştirilmiş kaliteli chrome vanadium çeliği.
- 1/2" lokma anahtarlar ve lokmalı bitslerle kullanım için.

KOD NO Code No	ÖLÇÜ mm		AĞIRLIK Weight	PAKET/KOLİ Package/Box	FİYAT Price
RTK0407	7 mm		193 gr	35 / 70 adet	
RTK0411	11 mm		291 gr	35 / 70 adet	
RTK0412	12 mm		293 gr	35 / 70 adet	



15
PCS

1/2" LOKMA TAKIMI - 6 KÖŞE



- İÇERİK: Cırcır Kol, Uzatma 125 mm, Mafsal, T Kol , Buji Anahtar 21 mm
- ● 10, 11, 12, 13, 15, 17,19, 21, 22, 24 mm
- Parlak krom kaplı sertleştirilmiş kaliteli chrome vanadium çeliği.
- Lokmalar plastik seperatördeki yuvalarına sıralı yerleştirilmiştir.

KOD NO Code No	İÇERİK Details	PAKET/KOLİ Package/Box	FİYAT Price
RLT1502	15 pcs	1 / 6 adet	

18
PCS

1/2" LOKMA TAKIMI - 6 KÖŞE



- İÇERİK: Cırcır Kol, Uzatma 125-250 mm, Mafsal, T Kol
- ● 10, 11, 12, 13, 14, 15, 17,19, 22, 24, 27, 30, 32 mm
- Lokmalar plastik seperatördeki yuvalarına sıralı yerleştirilmiştir.
- Cırcır kollar ergonomik olarak dizayn edilmiştir.
- Parlak krom kaplı sertleştirilmiş kaliteli chrome vanadium çeliği.

KOD NO Code No	İÇERİK Details	PAKET/KOLİ Package/Box	FİYAT Price
RLT1801	18 pcs	1 / 4 adet	

25
PCS

1/2" LOKMA TAKIMI - 6 KÖŞE



- İÇERİK: Cırcır Kol, Uzatma 125-250 mm, Mafsal, T Kol, Buji Lokması: 16, 21mm
- ●10, 11, 12, 13, 14, 15, 16, 17, 18, 19, 20, 21, 22, 23, 24, 27, 30, 32 mm
- Lokmalar plastik seperatördeki yuvalarına sıralı yerleştirilmiştir.
- Cırcır kollar ergonomik olarak dizayn edilmiştir.
- Parlak krom kaplı sertleştirilmiş kaliteli chrome vanadium çeliği.

KOD NO Code No	İÇERİK Details	PAKET/KOLİ Package/Box	FİYAT Price
RLT2502	25 pcs	1 / 4 adet	

1/2" LOKMA TAKIMI - 12 KÖŞE

- İÇERİK: Cırcır Kol, Uzatma 125-250 mm, Mafsal, T Kol, Buji Lokması: 16, 21mm
- ●10, 11, 12, 13, 14, 15, 16, 17, 18, 19, 20, 21, 22, 23, 24, 27, 30, 32 mm
- Parlak krom kaplı sertleştirilmiş kaliteli chrome vanadium çeliği.
- Lokmalar plastik seperatördeki yuvalarına sıralı yerleştirilmiştir.
- Cırcır kol ergonomik olarak dizayn edilmiştir.

25
PCS



KOD NO Code No	İÇERİK Details	PAKET/KOLİ Package/Box	FİYAT Price
RLT2503	25 pcs	1 / 4 adet	

1/2" LOKMA TAKIMI UZATMALI - 6 KÖŞE

- İÇERİK:Uzatmalı Cırcır Kol, Uzatma 125-250 mm, Mafsal, T Kol, Buji Lokması: 16, 21mm
- ●10, 11, 12, 13, 14, 15, 16, 17, 18, 19, 20, 21, 22, 23, 24, 27, 30, 32 mm
- Parlak krom kaplı sertleştirilmiş kaliteli chrome vanadium çeliği.
- Lokmalar plastik seperatördeki yuvalarına sıralı yerleştirilmiştir.
- Uzatmalı cırcır kol ile sunulmuştur.

25
PCS



KOD NO Code No	İÇERİK Details	PAKET/KOLİ Package/Box	FİYAT Price
RLT2501	25 pcs	1 / 4 adet	

1/2" - 1/4" LOKMA TAKIMI - 6 KÖŞE

- 1/2 ve 1/4 Cırcır Kol, 1/4 Uzatma 55 mm, 1/2 ve 1/4 Mafsal,
- 1/2 Buji Lokması 16 mm ve 21 mm, 1/2 Uzatma 75 mm ve 250 mm,
- 1/2 T Kol, 1/4 T Kol, 1/4 Lokma Tornavida, Alyan: 1.25, 1.5, 2, 2.5, 3 mm
- 1/4" ● 4, 4.5, 5, 5.5, 6, 7, 8, 9, 10, 11, 12, 13 mm
- 1/2" ●10, 11, 12, 13, 14, 15, 17, 19, 22, 24, 27, 30, 32 mm
 - T15, T20, T25, T27, T30 ● 4, 5.5 mm
 - PH1,PH2 ● 4, 5, 6 mm

55
PCS



KOD NO Code No	İÇERİK Details	PAKET/KOLİ Package/Box	FİYAT Price
RLT5601	55 pcs	1 / 4 adet	

16
PCS

1/2" LOKMA TAKIMI - 6 KÖŞE



- İÇERİK: Döner Saplı Cırcır Kol, Uzatma 125 mm, Mafsal, T Kol
- 10, 11, 12, 13, 14, 15, 16, 17, 18, 19, 22, 24 mm
- Parlak krom kaplı sertleştirilmiş kaliteli chrome vanadium çeliği.
- Lokmalar plastik seperetördeki yuvalarına sıralı yerleştirilmiştir.
- Cırcır kol ergonomik olarak dizayn edilmiştir.
- Döner saplı cırcır kol.

KOD NO Code No	İÇERİK Details	PAKET/KOLİ Package/Box	FIYAT Price
RLT1601	25 pcs	1 / 4 adet	

25
PCS

1/2" LOKMA TAKIMI - 12 KÖŞE - INCH



- İÇERİK: Cırcır Kol, Uzatma 125-250 mm, Mafsal, T Kol, Buji Lokması: 16-21 mm
- 3/8", 7/16", 1/2", 9/16", 19/32", 5/8", 11/16", 3/4", 25/32", 13/16", 7/8", 15/16", 1", 1-1/16", 1-1/8", 1-3/16", 1-1/4" inch
- Gerilime dayanıklı sac kutu ambalaj.
- Lokmalar plastik tepsilerdeki yuvalarına sıralı yerleştirilmiştir.
- Cırcır kol ergonomik olarak dizayn edilmiştir.

KOD NO Code No	İÇERİK Details	PAKET/KOLİ Package/Box	FIYAT Price
RLT2504	25 pcs	1 / 4 adet	

15
PCS

1/2" İÇ-DIŞ TORX LOKMA TAKIMI



- İÇERİK: 1/2" T Kol
- T20, T25, T27, T30, T35, T40, T45, T50
- E12, E14, E16, E18, E22, E24
- Lokmalar plastik seperetördeki yuvalarına sıralı yerleştirilmiştir.
- Parlak krom kaplı sertleştirilmiş kaliteli chrome vanadium çeliği.

KOD NO Code No	İÇERİK Details	PAKET/KOLİ Package/Box	FIYAT Price
RLT1501	15 pcs	1 / 4 adet	

1/2" LOKMA TAKIMI UZUN - 6 KÖŞE



- İÇERİK: ● 10, 11, 13, 14, 17, 19, 21, 22, 24, 27 mm
- Gerilime dayanıklı sac kutu ambalaj.
- Lokmalar plastik seperetördeki yuvalarına sıralı yerleştirilmiştir.
- Uzatmalı cırcır kol ile sunulmuştur..



KOD NO Code No	İÇERİK Details	PAKET/KOLİ Package/Box	FİYAT Price
RLT1006	10 pcs	1 / 4 adet	

1/2" LOKMA TAKIMI UZUN- 12 KÖŞE



- İÇERİK: ● 10, 11, 13, 14, 17, 19, 21, 22, 24, 27 mm
- Gerilime dayanıklı sac kutu ambalaj.
- Lokmalar plastik seperetördeki yuvalarına sıralı yerleştirilmiştir.
- Uzatmalı cırcır kol ile sunulmuştur..



KOD NO Code No	İÇERİK Details	PAKET/KOLİ Package/Box	FİYAT Price
RLT1012	10 pcs	1 / 4 adet	

10MM TORX/ALLEN/XZN LOKMALI BITS SETİ



- 3/8" Bits Adaptör, 1/2" Bits Adaptör
- Kumlanmış, sertleştirilmiş kaliteli chrome vanadium çeliğinden bitsler.

30 mm

- 4, 5, 6, 7, 8, 10, 12mm
- T20, T25, T30, T40, T45, T50, T55
- M5, M6, M8, M10, M12

75 mm

- 4, 5, 6, 7, 8, 10, 12mm
- T20, T25, T30, T40, T45, T50, T55
- M5, M6, M8, M10, M12



KOD NO Code No	İÇERİK Details	PAKET/KOLİ Package/Box	FİYAT Price
RTS0141	40 pcs	1 / 4 adet	



1/2" LOKMALI ALLEN SET KISA - 6 KÖŞE



- 5, 6, 7, 8, 10, 12, 14, 17, 19 mm
- Lokmalar plastik seperetördeki yuvalarına sıralı yerleştirilmiştir.
- Parlak krom kaplı sertleştirilmiş kaliteli chrome vanadium çeliği.

KOD NO Code No	İÇERİK Details	PAKET/KOLİ Package/Box	FİYAT Price
RLT0901	9 pcs	1 / 15 adet	



1/2" LOKMALI ALLEN SET UZUN - 6 KÖŞE



- 5, 6, 7, 8, 9, 10, 12, 14, 17 mm
- Lokmalar plastik seperetördeki yuvalarına sıralı yerleştirilmiştir.
- Parlak krom kaplı sertleştirilmiş kaliteli chrome vanadium çeliği.

KOD NO Code No	İÇERİK Details	PAKET/KOLİ Package/Box	FİYAT Price
RLT0902	9 pcs	1 / 15 adet	



1/2" LOKMALI TORX SET KISA - 6 KÖŞE



- T20, T25, T27, T30, T35, T40, T45, T55, T60 mm
- Lokmalar plastik seperetördeki yuvalarına sıralı yerleştirilmiştir.
- Parlak krom kaplı sertleştirilmiş kaliteli chrome vanadium çeliği.

KOD NO Code No	İÇERİK Details	PAKET/KOLİ Package/Box	FİYAT Price
RKT2060	9 pcs	1 / 15 adet	



1/2" LOKMALI TORX SET UZUN - 6 KÖŞE



- T20, T25, T27, T30, T35, T40, T45, T55, T60 mm
- Gerilime dayanıklı sac kutu ambalaj.
- Parlak krom kaplı sertleştirilmiş kaliteli chrome vanadium çeliği.

KOD NO Code No	İÇERİK Details	PAKET/KOLİ Package/Box	FİYAT Price
RUT2060	9 pcs	1 / 15 adet	

1/2" LOKMALI TORX BITS SET - 6 KÖŞE



18
PCS

- 1/4 Kısa: T8, T10, T15, T20, T25, T27
- 1/2 Kısa: T30, T40, T45, T50, T55, T60
- 1/2 Uzun: T30, T40, T45, T50, T55, T60

KOD NO Code No	İÇERİK Details	PAKET/KOLİ Package/Box	FİYAT Price
RLT1901	18 pcs	1 / 4 adet	



1/2" - 3/8" LOKMALI RIBE SET



7
PCS

- İÇERİK: Döner Saplı Cırcır Kol, Uzatma 125 mm, Mafsal, T Kol
- M6, M8, M10, M12, M14, M16
- Altı köşeli vidalar için ribe uçlar.
- Kumlanmış, sertleştirilmiş kaliteli chrome vanadium çeliğinden bitsler.
- Parlak krom kaplı sertleştirilmiş kaliteli chrome vanadium çelik tutucu.

KOD NO Code No	İÇERİK Details	PAKET/KOLİ Package/Box	FİYAT Price
RTS0701	7 pcs	1 / 4 adet	



1/2" TORX SET - 6 KÖŞE



13
PCS

- Altı köşeli vidalar için bits uçlar.
- Kumlanmış, sertleştirilmiş kaliteli chrome vanadium çeliğinden bitsler.
- İÇERİK: 1/2" Lokma Adaptör
- UZUN: T30, T40, T45, T50, T55, T60 • KISA: T30, T40, T45, T50, T55, T60

KOD NO Code No	İÇERİK Details	PAKET/KOLİ Package/Box	FİYAT Price
RTS1301	13 pcs	1 / 4 adet	



1/2" TORX SET - 12 KÖŞE



13
PCS

- XZN vidalar için bits uçlar.
- Kumlanmış, sertleştirilmiş kaliteli chrome vanadium çeliğinden bitsler.
- İÇERİK: 1/2" Lokma Adaptör
- UZUN: M6, M8, M10, M12, M14, M16 • KISA: M6, M8, M10, M12, M14, M16

KOD NO Code No	İÇERİK Details	PAKET/KOLİ Package/Box	FİYAT Price
RSS1301	13 pcs	1 / 4 adet	





3/4" SERİSİ



3/4" CIRCIR KOLU

- Parlak krom kaplı sertleştirilmiş kaliteli chrome vanadium çeliği.
- 3/4" lokma anahtarlar ve lokmalı bitsler ile kullanım için.
- 24 dişli hassas circir mekanizması.

3/4"

CHROME
CrV
VANADIUM

KOD NO Code No	ÖLÇÜ mm	AĞIRLIK Weight	PAKET/KOLİ Package/Box	FİYAT Price
RCK3500	500 mm	2044 gr	4 / 16 adet	



3/4" T KOL

- Parlak krom kaplı sertleştirilmiş kaliteli chrome vanadium çeliği.
- 3/4" lokma anahtarlar için T kol.

3/4"

CHROME
CrV
VANADIUM

KOD NO Code No	ÖLÇÜ mm	AĞIRLIK Weight	PAKET/KOLİ Package/Box	FİYAT Price
RTK3445	460 mm	1725 gr	10 / 20 adet	



3/4" LOKMA TAKIMI - 6 KÖŞE



- İÇERİK: Circir Kol, Uzatma 100-200 mm, T Kol
- ● 22, 24, 27, 30, 32, 36, 38, 41, 46, 50 mm
- Parlak krom kaplı sertleştirilmiş kaliteli chrome vanadium çeliği.

3/4"

CHROME
CrV
VANADIUM

KOD NO Code No	İÇERİK Details	PAKET/KOLİ Package/Box	FİYAT Price
RLT0015	14 pcs	1 adet	



3/4" LOKMA TAKIMI - 12 KÖŞE



- İÇERİK: Circir Kol, Uzatma 100-200 mm, T Kol
- ● 22, 24, 27, 30, 32, 36, 38, 41, 46, 50 mm
- Parlak krom kaplı sertleştirilmiş kaliteli chrome vanadium çeliği.

3/4"

CHROME
CrV
VANADIUM

KOD NO Code No	İÇERİK Details	PAKET/KOLİ Package/Box	FİYAT Price
RLT0014	14 pcs	1 adet	



3/4" LOKMA ANAHTAR KISA - 6 KÖŞE

- Altı köşe civatalar için lokma anahtarlar.
- Parlak krom kaplı sertleştirilmiş kaliteli chrome vanadium çeliği.



KOD NO Code No	ÖLÇÜ mm	PAKET/KOLİ Package/Box	FIYAT Price
RLA3419	19 mm	25 / 80 adet	
RLA3421	21 mm	25 / 80 adet	
RLA3422	22 mm	25 / 80 adet	
RLA3424	24 mm	25 / 80 adet	
RLA3427	27 mm	25 / 80 adet	
RLA3430	30 mm	25 / 60 adet	
RLA3432	32 mm	20 / 60 adet	
RLA3436	36 mm	20 / 50 adet	
RLA3438	38 mm	25 / 40 adet	
RLA3441	41 mm	20 / 40 adet	
RLA3446	46 mm	10 / 20 adet	
RLA3450	50 mm	10 / 20 adet	
RLA3455	55 mm	10 / 20 adet	
RLA3460	60 mm	10 / 20 adet	



3/4" LOKMA ANAHTAR KISA - 12 KÖŞE

- Oniki köşe civatalar için lokma anahtarlar.
- Parlak krom kaplı sertleştirilmiş kaliteli chrome vanadium çeliği.



KOD NO Code No	ÖLÇÜ mm	PAKET/KOLİ Package/Box	FIYAT Price
RYA3419	19 mm	25 / 80 adet	
RYA3421	21 mm	25 / 80 adet	
RYA3422	22 mm	25 / 80 adet	
RYA3424	24 mm	25 / 80 adet	
RYA3427	27 mm	25 / 80 adet	
RYA3430	30 mm	20 / 60 adet	
RYA3432	32 mm	20 / 60 adet	
RYA3436	36 mm	25 / 50 adet	
RYA3438	38 mm	10 / 40 adet	
RYA3441	41 mm	10 / 40 adet	
RYA3446	46 mm	10 / 20 adet	
RYA3450	50 mm	10 / 20 adet	
RYA3455	55 mm	10 / 20 adet	
RYA3460	60 mm	10 / 20 adet	
RYA3465	65mm	5 / 20 adet	



3/4" SERİSİ

3/4" - 1" LOKMA ADAPTÖR

- Parlak krom kaplı sertleştirilmiş kaliteli chrome vanadium çeliği.
- 1" lokma anahtarlar için kullanım.

KOD NO Code No	ÖLÇÜ mm	PAKET/KOLİ Package/Box	FİYAT Price
RAL3410	3/4">1"	12 / 96 adet	



3/4" - 1/2" LOKMA ADAPTÖR

- Parlak krom kaplı sertleştirilmiş kaliteli chrome vanadium çeliği.
- 1/2" lokma anahtarlar için kullanım.

KOD NO Code No	ÖLÇÜ mm	PAKET/KOLİ Package/Box	FİYAT Price
RAL3412	3/4">1/2"	12 / 96 adet	



3/4" LOKMALI ALLEN

- Parlak krom kaplı sertleştirilmiş kaliteli chrome vanadium çeliği.

KOD NO Code No	ÖLÇÜ mm	AĞIRLIK Weight	PAKET/KOLİ Package/Box	FİYAT Price
RAL3414	14 mm	307 gr	12 / 60 adet	
RAL3417	17 mm	323 gr	12 / 60 adet	
RAL3419	19 mm	335 gr	12 / 60 adet	
RAL3422	22 mm	385 gr	12 / 60 adet	



3/4" UZATMA KOLU

- Parlak krom kaplı sertleştirilmiş kaliteli chrome vanadium çeliği.
- 3/4" lokma anahtarlar ve lokmalı bitslerle kullanım için.

KOD NO Code No	ÖLÇÜ mm	AĞIRLIK Weight	PAKET/KOLİ Package/Box	FİYAT Price
RUK3410	100 mm	433 gr	1 / 20 adet	
RUK3420	200 mm	788 gr	1 / 20 adet	
RUK3440	400 mm	1485 gr	1 / 20 adet	



1" SERİSİ

1" LOKMA ANAHTAR KISA - 12 KÖŞE

- Parlak krom kaplı sertleştirilmiş kaliteli chrome vanadium çeliği.
- Oniki köşe civatalar için lokma anahtarlar.

KOD NO Code No	ÖLÇÜ mm	AĞIRLIK Weight	PAKET/KOLİ Package/Box	FİYAT Price
RYA0136	36 mm	496 gr	10 / 40 adet	
RYA0141	41 mm	560 gr	10 / 20 adet	
RYA0146	46 mm	817 gr	10 / 20 adet	
RYA0150	50 mm	903 gr	10 / 20 adet	
RYA0155	55 mm	1138 gr	6/10 adet	
RYA0160	60 mm	1345 gr	6/10 adet	
RYA0180	80 mm	2213 gr	3/8 adet	



1" CİRCİR KOLU UZATMALI

- Parlak krom kaplı sertleştirilmiş kaliteli chrome vanadium çeliği.
- 1" lokma anahtarlar için.
- 48 dişli hassas cırcır mekanizması

KOD NO Code No	ÖLÇÜ mm	AĞIRLIK Weight	PAKET/KOLİ Package/Box	FİYAT Price
RCK1085	1143 mm	5984 gr	1 / 3 adet	



1" T KOL

- Parlak krom kaplı sertleştirilmiş kaliteli chrome vanadium çeliği.
- 1" lokma anahtarlar için T kol.

KOD NO Code No	ÖLÇÜ mm	AĞIRLIK Weight	PAKET/KOLİ Package/Box	FİYAT Price
RTK0155	500 mm	2015 gr	4 / 8 adet	



1" UZATMA KOLU

- Parlak krom kaplı sertleştirilmiş kaliteli chrome vanadium çeliği.
- 1" lokma anahtarlar için.

KOD NO Code No	ÖLÇÜ mm	AĞIRLIK Weight	PAKET/KOLİ Package/Box	FİYAT Price
RUK0120	200 mm	1143 gr	5 / 10 adet	
RUK0140	400 mm	1924 gr	5 / 10 adet	

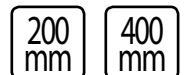
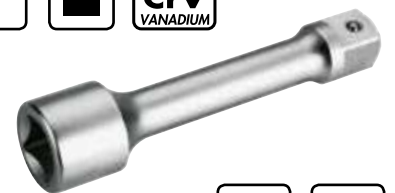



1/2" HAVALI LOKMA ANAHTAR KISA - 6 KÖŞE

- Siyah fosfat kaplı sertleştirilmiş chrome molybdenum malzeme.
- Altı köşe civatalar için lokma anahtarlar.

KOD NO Code No	ÖLÇÜ mm	PAKET/KOLİ Package/Box	FİYAT Price
RHL1208	8 mm	24 / 288 adet	
RHL1210	10 mm	24 / 288 adet	
RHL1211	11 mm	24 / 288 adet	
RHL1212	12 mm	24 / 288 adet	
RHL1213	13 mm	24 / 288 adet	
RHL1215	15 mm	24 / 288 adet	
RHL1217	17 mm	12 / 192 adet	
RHL1218	18 mm	24 / 192 adet	
RHL1219	19 mm	24 / 144 adet	
RHL1221	21 mm	10 / 144 adet	
RHL1227	27 mm	24 / 96 adet	
RHL1230	30 mm	24 / 96 adet	
RHL1232	32 mm	24 / 96 adet	



1/2" HAVALI LOKMA ANAHTAR UZUN - 6 KÖŞE

- Siyah fosfat kaplı sertleştirilmiş chrome molybdenum malzeme.
- Altı köşe civatalar için lokma anahtarlar.

KOD NO Code No	ÖLÇÜ mm	PAKET/KOLİ Package/Box	FİYAT Price
RHD1213	13 mm	25 / 144 adet	
RHD1217	17 mm	25 / 96 adet	
RHD1218	18 mm	25 / 96 adet	
RHD1219	19 mm	25 / 96 adet	
RHD1221	21 mm	24 / 48 adet	
RHD1222	22 mm	24 / 48 adet	
RHD1224	24 mm	24 / 48 adet	
RHD1227	27 mm	24 / 48 adet	
RHD1230	30 mm	24 / 48 adet	

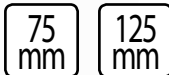

1/2" HAVALI UZATMA KOLU

- Siyah fosfat kaplı sertleştirilmiş chrome molybdenum malzeme.
- 1/2" lokma anahtarlar ve lokmalı bitslerle kullanım için.

KOD NO Code No	ÖLÇÜ mm	AĞIRLIK Weight	PAKET/KOLİ Package/Box	FİYAT Price
RHU2075	75 mm	158 gr	25 / 100 adet	
RHU2125	125 mm	241 gr	25 / 100 adet	

1/2" HAVALI ALLEN LOKMA

- Siyah fosfat kaplı sertleştirilmiş chrome molybdenum malzeme.
- Sadece havalı cırcır makinaları ile kullanıma uygundur.

KOD NO Code No	ÖLÇÜ mm	AĞIRLIK Weight	PAKET/KOLİ Package/Box	FİYAT Price
RHA0460	4 mm	64 gr	10 / 60 adet	
RHA0560	5 mm	68 gr	10 / 60 adet	
RHA0660	6 mm	73 gr	10 / 60 adet	
RHA0760	7 mm	76 gr	10 / 40 adet	
RHA0860	8 mm	76 gr	10 / 40 adet	
RHA1060	10 mm	89 gr	10 / 40 adet	
RHA1260	12 mm	97 gr	10 / 40 adet	
RHA1460	14 mm	112 gr	10 / 40 adet	
RHA1760	17 mm	134 gr	10 / 20 adet	



*Havalı cırcır kolu ile kullanıma uygundur.
Yüksek torklu tabanca ile kullanılmaz

1/2" HAVALI TORX LOKMA - 6 KÖŞE

- Siyah fosfat kaplı sertleştirilmiş chrome molybdenum malzeme.
- Sadece havalı cırcır makinaları ile kullanıma uygundur.

KOD NO Code No	ÖLÇÜ mm	AĞIRLIK Weight	PAKET/KOLİ Package/Box	FİYAT Price
RHT5560	T55	87 gr	10 / 40 adet	
RHT8060	T80	126 gr	10 / 40 adet	

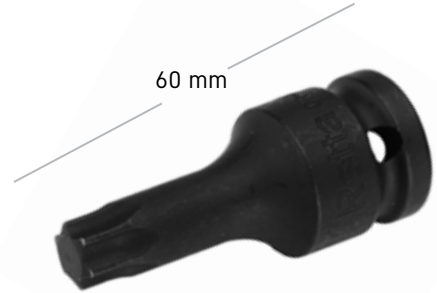

*Havalı cırcır kolu ile kullanıma uygundur.
Yüksek torklu tabanca ile kullanılmaz

1/2" HAVALI UNIVERSAL MAFSAL

- Siyah fosfat kaplı sertleştirilmiş chrome molybdenum malzeme.
- 1/2" lokma anahtarlar için mafsal.

KOD NO Code No	ÖLÇÜ mm	AĞIRLIK Weight	PAKET/KOLİ Package/Box	FİYAT Price
RHM0012	80 mm	171 gr	25 / 100 adet	



1/2" - 3/4" HAVALI LOKMA ADAPTÖR

- Siyah fosfat kaplı sertleştirilmiş chrome molybdenum malzeme.
- 1/2" lokma anahtarlar için adaptör.

KOD NO Code No	ÖLÇÜ mm	AĞIRLIK Weight	PAKET/KOLİ Package/Box	FİYAT Price
RHA1234	1/2">3/4"	171 gr	25 / 100 adet	





9
PCS

GARANTİ
KAPSAM DIŞI



1/2" HAVALI ALLEN LOKMA SET



- 6, 7, 8, 9, 10, 12, 14, 17, 19 mm
- Siyah fosfat kaplı sertleştirilmiş chrome molybdenum malzeme.
- Altı köşe civatalar için lokma anahtarlar.

KOD NO Code No	İÇERİK Details	PAKET/KOLİ Package/Box	FİYAT Price
RAS0619	9 pcs	1 / 10 adet	

9
PCS

GARANTİ
KAPSAM DIŞI



1/2" HAVALI TORX LOKMA SET - 6 KÖŞE



- T25, T27, T30, T35, T40, T45, T50, T55, T60
- Siyah fosfat kaplı sertleştirilmiş chrome molybdenum malzeme.
- Altı köşe civatalar için lokma anahtarlar.

KOD NO Code No	İÇERİK Details	PAKET/KOLİ Package/Box	FİYAT Price
RTS2560	9 pcs	1 / 10 adet	

10
PCS



1/2" HAVALI LOKMA SET - 6 KÖŞE



- 10, 11, 12, 13, 14, 15, 16, 17, 19, 21 mm
- Siyah fosfat kaplı sertleştirilmiş chrome molybdenum malzeme.
- Altı köşe civatalar için lokma anahtarlar.

KOD NO Code No	İÇERİK Details	PAKET/KOLİ Package/Box	FİYAT Price
RHD1200	10 pcs	1 / 10 adet	

3/4"



CHROME
Cr-Mo
MOLYBDENUM

DIN
3124



3/4" HAVALI LOKMA ANAHTAR KISA - 6 KÖŞE

- Siyah fosfat kaplı sertleştirilmiş chrome molybdenum malzeme.
- Altı köşe civatalar için lokma anahtarlar.

KOD NO Code No	ÖLÇÜ mm	PAKET/KOLİ Package/Box	FİYAT Price
RHL3419	19 mm	10 / 60 adet	
RHL3421	21 mm	10 / 60 adet	
RHL3424	24 mm	10 / 40 adet	
RHL3427	27 mm	10 / 40 adet	
RHL3430	30 mm	10 / 40 adet	
RHL3432	32 mm	10 / 40 adet	
RHL3433	33 mm	10 / 40 adet	
RHL3434	34 mm	10 / 40 adet	
RHL3436	36 mm	10 / 40 adet	
RHL3438	38 mm	10 / 40 adet	
RHL3441	41 mm	10 / 20 adet	
RHL3446	46 mm	10 / 20 adet	
RHL3450	50 mm	6 / 20 adet	
RHL3455	55 mm	6 / 20 adet	
RHL3460	60 mm	6 / 20 adet	
RHL3465	65 mm	6 / 20 adet	

3/4"



CHROME
Cr-Mo
MOLYBDENUM

DIN
3124



3/4" HAVALI LOKMA ANAHTAR UZUN - 6 KÖŞE

- Siyah fosfat kaplı sertleştirilmiş chrome molybdenum malzeme.
- Altı köşe civatalar için lokma anahtarlar

KOD NO Code No	ÖLÇÜ mm	PAKET/KOLİ Package/Box	FİYAT Price
RHD3419	19 mm	15 / 60 adet	
RHD3421	21 mm	15 / 60 adet	
RHD3424	24 mm	15 / 40 adet	
RHD3427	27 mm	12 / 40 adet	
RHD3430	30 mm	12 / 40 adet	
RHD3432	32 mm	12 / 40 adet	
RHD3436	36 mm	10 / 40 adet	
RHD3438	38 mm	10 / 40 adet	
RHD3441	41 mm	6 / 20 adet	
RHD3446	46 mm	6 / 20 adet	

3/4" HAVALI UZATMA KOLU

- Siyah fosfat kaplı sertleştirilmiş chrome molybdenum malzeme.
- Lokma anahtarlar için uzatma kol.

KOD NO Code No	ÖLÇÜ mm	AĞIRLIK Weight	PAKET/KOLİ Package/Box	FİYAT Price
RHU3175	175 mm	921 gr	1 / 20 adet	

3/4"



CHROME
Cr-Mo
MOLYBDENUM



175
mm



3/4"

CHROME
Cr-Mo
MOLYBDENUMGARANTİ
KAPSAM DIŞI

3/4" HAVALI UNIVERSAL MAFSAL

- Siyah fosfat kaplı sertleştirilmiş chrome molybdenum malzeme.
- Lokma anahtarlar için mafsal.

KOD NO Code No	ÖLÇÜ mm	AĞIRLIK Weight	PAKET/KOLİ Package/Box	FİYAT Price
RHM0034	80 mm	500 gr	10 / 40 adet	

3/4"
1/2"CHROME
Cr-Mo
MOLYBDENUMGARANTİ
KAPSAM DIŞI

3/4" - 1/2" HAVALI LOKMA ADAPTÖR

- Siyah fosfat kaplı sertleştirilmiş chrome molybdenum malzeme.
- Lokma anahtarlar için adaptör.

KOD NO Code No	ÖLÇÜ mm	AĞIRLIK Weight	PAKET/KOLİ Package/Box	FİYAT Price
RHA3412	3/4">1/2"	500 gr	10 / 60 adet	

3/4"
1/2"CHROME
Cr-Mo
MOLYBDENUMGARANTİ
KAPSAM DIŞI

3/4" - 1/2" HAVALI LOKMA ADAPTÖR

- Siyah fosfat kaplı sertleştirilmiş chrome molybdenum malzeme.
- Lokma anahtarlar için adaptör.

KOD NO Code No	ÖLÇÜ mm	AĞIRLIK Weight	PAKET/KOLİ Package/Box	FİYAT Price
RAH3412	3/4">1/2"	347 gr	10 / 60 adet	
RAH3412R	Yedek Uç	5 gr	1 / 10 adet	

1"

CHROME
Cr-Mo
MOLYBDENUM

1" HAVALI UZATMA KOLU

- Siyah fosfat kaplı sertleştirilmiş chrome molybdenum malzeme.
- Lokma anahtarlar için uzatma kol.

KOD NO Code No	ÖLÇÜ mm	AĞIRLIK Weight	PAKET/KOLİ Package/Box	FİYAT Price
RHU1175	175 mm	1278 gr	5 / 20 adet	
RHU1250	250 mm	1662 gr	1 / 20 adet	

1"

 CHROME
Cr-Mo
MOLYBDENUM

1" HAVALI LOKMA ANAHTAR KISA - 6 KÖŞE

- Siyah fosfat kaplı sertleştirilmiş chrome molybdenum malzeme.
- Altı köşe civatalar için lokma anahtarlar.

KOD NO Code No	ÖLÇÜ mm	PAKET/KOLİ Package/Box	FİYAT Price
RHL1024	24 mm	10 / 60 adet	
RHL1027	27 mm	10 / 60 adet	
RHL1030	30 mm	10 / 60 adet	
RHL1032	32 mm	10 / 40 adet	
RHL1033	33 mm	10 / 40 adet	
RHL1036	36 mm	10 / 40 adet	
RHL1038	38 mm	10 / 40 adet	
RHL1041	41 mm	10 / 40 adet	
RHL1046	46 mm	10 / 40 adet	
RHL1050	50 mm	10 / 20 adet	
RHL1055	55 mm	10 / 20 adet	
RHL1060	60 mm	10 / 20 adet	
RHL1065	65 mm	10 / 20 adet	
RHL1070	70 mm	10 / 20 adet	
RHL1075	75 mm	10 / 20 adet	
RHL1080	80 mm	10 / 20 adet	
RHL1085	85 mm	10 / 20 adet	
RHL1090	90 mm	10 / 20 adet	
RHL1100	100 mm	10 / 20 adet	

1"

 CHROME
Cr-Mo
MOLYBDENUM

1" HAVALI LOKMA ANAHTAR UZUN - 6 KÖŞE

- Siyah fosfat kaplı sertleştirilmiş chrome molybdenum malzeme.
- Altı köşe civatalar için lokma anahtarlar.

KOD NO Code No	ÖLÇÜ mm	PAKET/KOLİ Package/Box	FİYAT Price
RHD1024	24 mm	10 / 60 adet	
RHD1027	27 mm	10 / 60 adet	
RHD1030	30 mm	10 / 60 adet	
RHD1032	32 mm	10 / 40 adet	
RHD1036	36 mm	10 / 40 adet	
RHD1038	38 mm	10 / 40 adet	
RHD1041	41 mm	10 / 40 adet	
RHD1046	46 mm	10 / 40 adet	
RHD1065	65 mm	10 / 40 adet	

1" - 3/4" HAVALI LOKMA ADAPTÖR

KOD NO Code No	ÖLÇÜ mm	AĞIRLIK Weight	PAKET/KOLİ Package/Box	FİYAT Price
RAH1034	1" > 3/4"	592 gr	20 / 60 adet	
RAH1034R	Yedek Uç	5 gr	1 / 10 adet	

 CHROME
CrV
VANADIUM

1"

3/4"



TORK ANAHTARLAR





1/4" - 1/2" CIRCIRLI TORK ANAHTARLARI

- Mat krom kaplı sertleştirilmiş kaliteli chrome vanadium çeliği.
- 5 Nm hassasiyet.
- Nm / Kg / Lb-Ft / Lb-Inc cinsinden scala.
- Kalibrasyon sertifikalıdır.
- \pm % 4 tolerans



KOD NO Code No	KARE ÖLÇÜSÜ Square	ÖLÇÜ mm	AĞIRLIK Weight	PAKET/KOLİ Package/Box	FİYAT Price
RTK0225	1/4"	2-25 Nm	622 gr	1 / 24 adet	

KOD NO Code No	KARE ÖLÇÜSÜ Square	ÖLÇÜ mm	AĞIRLIK Weight	PAKET/KOLİ Package/Box	FİYAT Price
RTK1010	1/2"	10-100 Nm	1205 gr	1 / 12 adet	
RTK2020	1/2"	20-200 Nm	1675 gr	1 / 12 adet	
RTK6030	1/2"	60-300 Nm	1945 gr	1 / 12 adet	



1/2" TORK ANAHTARLAR

- Parlak krom kaplı sertleştirilmiş kaliteli chrome vanadium çeliği.
- Nm / Kg / Lb-Ft / Lb-Inc cinsinden scala.
- Sağ / sol kullanım kolaylığı sağlayan itmeli mekanizma.
- \pm % 4 tolerans



KOD NO Code No	ÖLÇÜ mm	AĞIRLIK Weight	PAKET/KOLİ Package/Box	FİYAT Price
RTK2513	25-135 Nm	1854 gr	1 / 20 adet	
RTK5022	50-225 Nm	1959 gr	1 / 20 adet	
RTK7033	70-330 Nm	3432 gr	1 / 20 adet	
RTK0001	Yedek Uç	10 gr	1 adet	

3/4" TORK ANAHTAR

- Endüstriyel amaçla üretilmiş extra hafif alüminyum tork anahtarı.
- Rüzgar gülleri, havacılık, makina ve otomasyon sanayinde kullanılır.
- \pm % 3 hassasiyet.
- DIN-ISO 6789
- Nm / Kg / Lb-Ft / Lb-Inc cinsinden scala.



KOD NO Code No	KAPASİTE Capacity	AĞIRLIK Weight	PAKET/KOLİ Package/Box	FİYAT Price
RTK3475	140-760 Nm	3800 gr	1 adet	



Endüstri



Enerji



Gemi Sanayi

TORK ARTTIRICI SET

- Giriş torku 231 Nm, azami çıkış torku: 1500 Nm.
- 6.5 kat tork artışı.
- Tork arttırıcıyı sabitlemek için Z tip kol uzatma.
- Kısa ve derin lokma kullanımına uygun.
- Aşırı yüklenme güvenlik adaptörü.



KOD NO Code No	İÇERİK Derails	AĞIRLIK Weight	PAKET/KOLİ Package/Box	FİYAT Price
RTA1234	5 pcs	6025 gr	1 adet	

1/2" TORK AÇI ÖLÇER

- Tork anahtarı ile açılı sıkma yapmak için kullanılır.

KOD NO Code No	ÖLÇÜ mm	AĞIRLIK Weight	PAKET/KOLİ Package/Box	FİYAT Price
RT01255	1/2" x 1/2"	190 gr	6 / 48 adet	



1/2" TELESKOPIK TORK AÇI ÖLÇER

- Tork anahtarı ile açılı sıkma yapmak için kullanılır.

KOD NO Code No	ÖLÇÜ mm	AĞIRLIK Weight	PAKET/KOLİ Package/Box	FİYAT Price
RT01250	1/2" x 1/2"	326 gr	5 / 40 Adet	





PENSELER



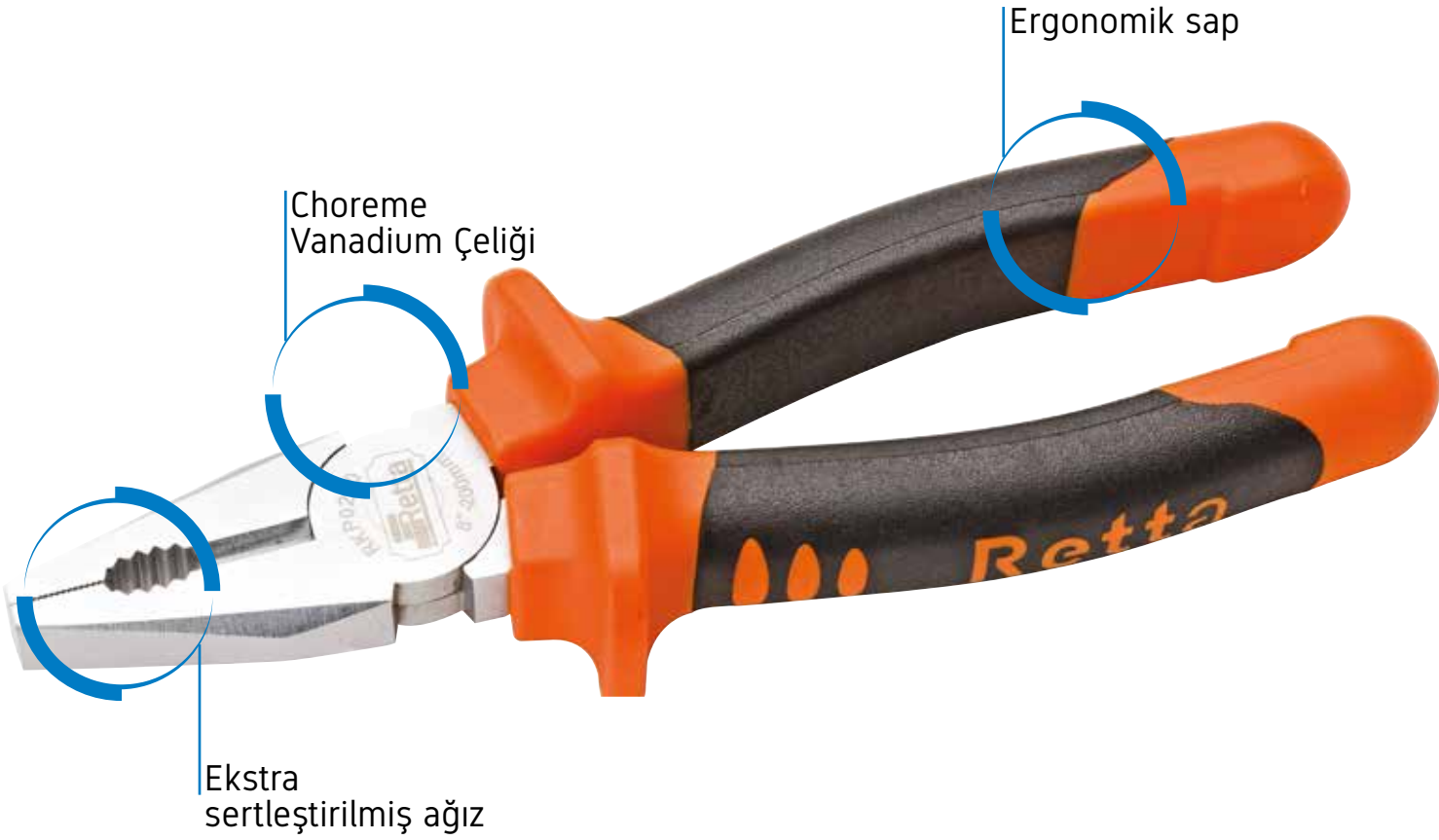

CHROME
CrV
VANADIUM

DIN
3124



KOMBİNE PENSE

- Yüksek vasıflı chrome vanadium çeliğinden üretilmiştir.
- İndüksiyonla sertleştirilmiş hassas kesici ağızlar.
- Mat krom kaplamalı yüzey ve yumuşak çift plastikli sap.

KOD NO Code No	ÖLÇÜ mm	PAKET/KOLİ Package/Box	FİYAT Price
RKP0160	160 mm	6 / 60 adet	
RKP0180	180 mm	6 / 60 adet	
RKP0200	200 mm	6 / 60 adet	

CHROME
CrV
VANADIUM

DIN
5749



YAN KESKİ

- Yüksek vasıflı chrome vanadium çeliğinden üretilmiştir.
- İndüksiyonla sertleştirilmiş hassas kesici ağızlar.
- Mat krom kaplamalı yüzey ve yumuşak çift plastikli sap.
- Tel kesme kapasiteleri
RYK0140 - 1,8 mm
RYK0160 - 2,0 mm
RYK0180 - 2,5 mm

KOD NO Code No	ÖLÇÜ mm	PAKET/KOLİ Package/Box	FİYAT Price
RYK0140	140 mm	6 / 60 adet	
RYK0160	160 mm	6 / 60 adet	
RYK0180	180 mm	6 / 60 adet	

KARGABURUN

- Yüksek vasıflı chrome vanadium çeliğinden üretilmiştir.
- İndüksiyonla sertleştirilmiş hassas kesici ağızlar.
- Mat krom kaplamalı yüzey ve yumuşak çift plastikli sap.
- Tel kesme kapasiteleri 1,6 mm

KOD NO Code No	ÖLÇÜ mm	PAKET/KOLİ Package/Box	FİYAT Price
RKB0160	160 mm	6 / 60 adet	
RKB0200	200 mm	6 / 60 adet	



KARGABURUN EĞRİ

- Yüksek vasıflı chrome vanadium çeliğinden üretilmiştir.
- İndüksiyonla sertleştirilmiş hassas kesici ağızlar.
- Mat krom kaplamalı yüzey ve yumuşak çift plastikli sap.
- Tel kesme kapasiteleri 1,6 mm

KOD NO Code No	ÖLÇÜ mm	PAKET/KOLİ Package/Box	FİYAT Price
RKE0160	160 mm	6 / 60 adet	
RKE0200	200 mm	6 / 60 adet	



KARGABURUN YUVARLAK

- Yüksek vasıflı chrome vanadium çeliğinden üretilmiştir.
- Mat krom kaplamalı yüzey ve yumuşak çift plastikli sap.

KOD NO Code No	ÖLÇÜ mm	PAKET/KOLİ Package/Box	FİYAT Price
RKY0160	160 mm	6 / 60 adet	



KABLO SIYIRMA PENSESİ

- Yüksek vasıflı chrome vanadium çeliğinden üretilmiştir.
- Mat krom kaplamalı yüzey ve yumuşak çift plastikli sap.

KOD NO Code No	ÖLÇÜ mm	PAKET/KOLİ Package/Box	FİYAT Price
RKS0160	160 mm	6 / 60 adet	





ÖZEL AĞIZLI AYARLI PENSE

Made in
Turkey

- Yüksek vasıflı chrome vanadium çeliğinden ağızlar.
- Gövdesi yüksek dayanımlı çelik sactan mamül sap.
- Nikel kaplama yüzey.

KOD NO Code No	ÖLÇÜ mm	PAKET/KOLİ Package/Box	FİYAT Price
RAP3000	240 mm	5 / 25 adet	



SPESİYAL AYARLI PENSE

- Yüksek vasıflı chrome vanadium çeliğinden ağızlar.
- Parlak krom kaplama yüzey.

KOD NO Code No	ÖLÇÜ mm	PAKET/KOLİ Package/Box	FİYAT Price
RAP0510	240 mm	10 / 50 adet	



UNIVERSAL AYARLI PENSE

Made in
Turkey

- Yüksek vasıflı chrome vanadium çeliğinden ağızlar.
- Gövdesi yüksek dayanımlı çelik sactan mamül sap.
- Nikel kaplama yüzey.

KOD NO Code No	ÖLÇÜ mm	PAKET/KOLİ Package/Box	FİYAT Price
RAP4000	240 mm	5 / 25 adet	



C TİPİ AYARLI PENSE

- Yüksek vasıflı chrome vanadium çeliğinden ağızlar.
- Gövdesi yüksek dayanımlı çelik sactan mamül sap.
- Nikel kaplama yüzey.

KOD NO Code No	ÖLÇÜ mm	PAKET/KOLİ Package/Box	FİYAT Price
RAP6100	240 mm	12 / 25 adet	



KAYNAKÇI AYARLI PENSE

- Yüksek vasıflı chrome vanadium çeliğinden ağızlar.
- Gövdesi yüksek dayanımlı çelik sactan mamül sap.
- Nikel kaplama yüzey.

KOD NO Code No	ÖLÇÜ mm	PAKET/KOLİ Package/Box	FİYAT Price
RAP5100	240 mm	5 / 25 adet	



FORT PENSE - 250

- Yüksek vasıflı chrome vanadium çeliğinden üretilmiştir.
- Altıgen parçalar ve boruları tutmakta kullanılır.
- Siyah fosfat kaplamalı yüzey ve PVC izoleli sap.

KOD NO Code No	ÖLÇÜ mm	PAKET/KOLİ Package/Box	FİYAT Price
RFP0250	250 mm	6 / 60 adet	



FORT PENSE - 300

- Yüksek vasıflı chrome vanadium çeliğinden üretilmiştir.
- Altıgen parçalar ve boruları tutmakta kullanılır.
- Siyah fosfat kaplamalı yüzey ve PVC izoleli sap.

KOD NO Code No	ÖLÇÜ mm	PAKET/KOLİ Package/Box	FİYAT Price
RFP0300	300 mm	6 / 60 adet	



KURBAĞACIK ANAHTAR KROM

- Yüksek vasıflı chrome vanadium çeliğinden üretilmiştir.
- Tesisatçılar için boru, somun ve düz parçalarda kullanılır.

KOD NO Code No	ÖLÇÜ mm	PAKET/KOLİ Package/Box	FİYAT Price
RKA0212	12" - 300 mm	6 / 24 adet	



MAXI GRIP FORT PENSE

- Yüksek vasıflı chrome vanadium çeliğinden üretilmiştir.
- Altıgen parçalar ve boruları tutmakta kullanılır.
- Siyah fosfat kaplamalı yüzey ve PVC izoleli sap.

KOD NO Code No	ÖLÇÜ mm	PAKET/KOLİ Package/Box	FİYAT Price
RFP2180	180 mm	6 / 36 adet	
RFP2250	250 mm	6 / 36 adet	

MAXI GRIP FORT PENSE

- Altıgen parçalar ve boruları tutmakta kullanılır.
- PVC izoleli sap.

KOD NO Code No	ÖLÇÜ mm	PAKET/KOLİ Package/Box	FİYAT Price
RFP0400	400 mm	6 / 60 adet	





GARANTİ
KAPSAM DIŐI



SEGMAN PENSESİ DİŐ DÜZ

- Yüksek vasıflı chrome vanadium çeliğinden üretilmiştir.
- Parlak krom kaplamalı yüzey ve PVC izoleli sap.

KOD NO Code No	ÖLÇÜ mm	PAKET/KOLİ Package/Box	FİYAT Price
RSP9002	225 mm	6 / 60 adet	

GARANTİ
KAPSAM DIŐI



SEGMAN PENSESİ DİŐ EĞRİ

- Yüksek vasıflı chrome vanadium çeliğinden üretilmiştir.
- Parlak krom kaplamalı yüzey ve PVC izoleli sap.

KOD NO Code No	ÖLÇÜ mm	PAKET/KOLİ Package/Box	FİYAT Price
RSP9001	225 mm	6 / 60 adet	

GARANTİ
KAPSAM DIŐI



SEGMAN PENSESİ İÇ DÜZ

- Yüksek vasıflı chrome vanadium çeliğinden üretilmiştir.
- Parlak krom kaplamalı yüzey ve PVC izoleli sap.

KOD NO Code No	ÖLÇÜ mm	PAKET/KOLİ Package/Box	FİYAT Price
RSP5504	140 mm	6 / 60 adet	
RSP9004	225 mm	6 / 60 adet	

GARANTİ
KAPSAM DIŐI



SEGMAN PENSESİ İÇ EĞRİ

- Yüksek vasıflı chrome vanadium çeliğinden üretilmiştir.
- Parlak krom kaplamalı yüzey ve PVC izoleli sap.

KOD NO Code No	ÖLÇÜ mm	PAKET/KOLİ Package/Box	FİYAT Price
RSP5503	140 mm	6 / 60 adet	
RSP9003	225 mm	6 / 60 adet	

MAXI GRIP SEGMAN PENSESİ DIŞ DÜZ

- Yüksek vasıflı chrome vanadium çeliğinden üretilmiştir.
- Siyah fosfat kaplamalı yüzey ve PVC izoleli sap.
- Görünmez yay mekanizması.
- Emniyet segmanları için kullanılır.

KOD NO Code No	ÖLÇÜ mm		AĞIRLIK Weight	PAKET/KOLİ Package/Box	FIYAT Price
RSP0510	140 mm	10-25 mm	103 gr	6 / 60 adet	
RSP0710	180 mm	15-60 mm	191 gr	6 / 60 adet	
RSP0910	225 mm	40-100 mm	307 gr	6 / 60 adet	



MAXI GRIP SEGMAN PENSESİ İÇ DÜZ

- Yüksek vasıflı chrome vanadium çeliğinden üretilmiştir.
- Siyah fosfat kaplamalı yüzey ve PVC izoleli sap.
- Görünmez yay mekanizması.
- Emniyet segmanları için kullanılır.

KOD NO Code No	ÖLÇÜ mm		AĞIRLIK Weight	PAKET/KOLİ Package/Box	FIYAT Price
RSP0520	140 mm	10-25 mm	103 gr	6 / 60 adet	
RSP0720	180 mm	15-60 mm	172 gr	6 / 60 adet	
RSP0920	225 mm	40-100 mm	300 gr	6 / 60 adet	



MAXI GRIP SEGMAN PENSESİ DIŞ EĞRİ

- Yüksek vasıflı chrome vanadium çeliğinden üretilmiştir.
- Siyah fosfat kaplamalı yüzey ve PVC izoleli sap.
- Görünmez yay mekanizması.
- Emniyet segmanları için kullanılır.

KOD NO Code No	ÖLÇÜ mm		AĞIRLIK Weight	PAKET/KOLİ Package/Box	FIYAT Price
RSP0515	140 mm	10-25 mm	101 gr	6 / 60 adet	
RSP0715	180 mm	15-60 mm	192 gr	6 / 60 adet	
RSP0915	225 mm	40-100 mm	292 gr	6 / 60 adet	



MAXI GRIP SEGMAN PENSESİ İÇ EĞRİ

- Yüksek vasıflı chrome vanadium çeliğinden üretilmiştir.
- Siyah fosfat kaplamalı yüzey ve PVC izoleli sap.
- Görünmez yay mekanizması.
- Emniyet segmanları için kullanılır.

KOD NO Code No	ÖLÇÜ mm		AĞIRLIK Weight	PAKET/KOLİ Package/Box	FIYAT Price
RSP0525	140 mm	10-25 mm	90 gr	6 / 60 adet	
RSP0725	180 mm	15-60 mm	171 gr	6 / 60 adet	
RSP0925	225 mm	40-100 mm	299 gr	6 / 60 adet	





RKP0650



ÖZEL SEGMAN PENSESİ - DÜZ

- Yüksek vasıflı chrome vanadium çeliğinden üretilmiştir.
- Mat krom kaplamalı yüzey ve PVC izoleli sap.

KOD NO Code No	ÖLÇÜ mm	PAKET/KOLİ Package/Box	FIYAT Price
RKP0650	200 mm	10 / 36 adet	



RKP0645



ÖZEL SEGMAN PENSESİ - EĞRİ

- Yüksek vasıflı chrome vanadium çeliğinden üretilmiştir.
- Mat krom kaplamalı yüzey ve PVC izoleli sap.

KOD NO Code No	ÖLÇÜ mm	PAKET/KOLİ Package/Box	FIYAT Price
RKP0645	200 mm	10 / 36 adet	



UZUN DÜZ KARGABURUN

- Yüksek vasıflı chrome vanadium çeliğinden üretilmiştir.
- Mat krom kaplamalı yüzey ve PVC izoleli sap.

KOD NO Code No	ÖLÇÜ mm	PAKET/KOLİ Package/Box	FIYAT Price
RUK1300	300 mm	5 / 36 adet	



UZUN EĞRİ KARGABURUN

- Yüksek vasıflı chrome vanadium çeliğinden üretilmiştir.
- Parlak krom kaplamalı yüzey ve PVC izoleli sap.

KOD NO Code No	ÖLÇÜ mm	PAKET/KOLİ Package/Box	FIYAT Price
RUK1345	300 mm	5 / 36 adet	



UZUN YUVARLAK KARGABURUN

- Yüksek vasıflı chrome vanadium çeliğinden üretilmiştir.
- Parlak krom kaplamalı yüzey ve PVC izoleli sap.

KOD NO Code No	ÖLÇÜ mm	PAKET/KOLİ Package/Box	FIYAT Price
RUK0360	300 mm	5 / 36 adet	

PLASTİKÇİ YANKESKİ

- Yüksek vasıflı chrome vanadium çeliğinden üretilmiştir.
- Endüksiyonla sertleştirilmiş hassas kesici ağızlar.
- Polisajlanmış yüzey ve daldırma PVC sap.

KOD NO Code No	ÖLÇÜ mm	PAKET/KOLİ Package/Box	FİYAT Price
RYP0125	125 mm	12 / 60 adet	
RYP0160	160 mm	12 / 60 adet	



AĞIR TİP YANKESKİ

- Yüksek vasıflı chrome vanadium çeliğinden üretilmiştir.
- Endüksiyonla sertleştirilmiş hassas kesici ağızlar.
- Polisajlanmış yüzey ve daldırma PVC sap.

KOD NO Code No	ÖLÇÜ mm	PAKET/KOLİ Package/Box	FİYAT Price
RTY0180	180 mm	6 / 60 adet	



KOMPAKT MİNİ KESKİ

- Tel, vida, çivi ve perçin kesim işlerini kolaylıkla yapar.
- KAPASİTE: 3.6 - 6.0 mm

KOD NO Code No	ÖLÇÜ mm	PAKET/KOLİ Package/Box	FİYAT Price
RKK0200	200 mm	6 / 60 adet	



MİKRO KARGABURUN UZUN

KOD NO Code No	ÖLÇÜ mm	PAKET/KOLİ Package/Box	FİYAT Price
RMU0615	120 mm	10 / 200 adet	



MİKRO TEPE KESKİ

KOD NO Code No	ÖLÇÜ mm	PAKET/KOLİ Package/Box	FİYAT Price
RMT1115	120 mm	10 / 200 adet	

 Paslanmaz Çelik





Paslanmaz Çelik



MİKRO YANKESKİ

- Özel mafsal tasarımı.
- Kaynaklanmış sactan yay mekanizması.

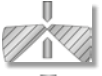

RMY2115 - Dışa Pahlı Kesim



RMY4115 - Düz Kesim

KOD NO Code No	ÖLÇÜ mm	PAKET/KOLİ Package/Box	FİYAT Price
RMY2115	115 mm	6 / 60 adet	
RMY4115	115 mm	6 / 60 adet	

Paslanmaz Çelik



MİKRO YANKESKİ

- Özel mafsal tasarımı.
- Kaynaklanmış sactan yay mekanizması.

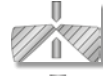

RMY1115 - Dışa Pahlı Kesim



RMY5115 - Düz Kesim

KOD NO Code No	ÖLÇÜ mm	PAKET/KOLİ Package/Box	FİYAT Price
RMY1115	120 mm	6 / 200 adet	
RMY5115	120 mm	6 / 200 adet	

Paslanmaz Çelik



MİKRO YANKESKİ

KOD NO Code No	ÖLÇÜ mm	PAKET/KOLİ Package/Box	FİYAT Price
RMY3115	120 mm	10 / 200 adet	

Paslanmaz Çelik



MİKRO KOMBİNE PENSE

- Özel mafsal tasarımı.
- Kaynaklanmış sactan yay mekanizması.

KOD NO Code No	ÖLÇÜ mm	PAKET/KOLİ Package/Box	FİYAT Price
RMK8115	130 mm	10 / 120 adet	

Paslanmaz Çelik



MİKRO EĞRİ KARGABURUN DIŞLI

- Özel mafsal tasarımı.
- Kaynaklanmış sactan yay mekanizması.

KOD NO Code No	ÖLÇÜ mm	PAKET/KOLİ Package/Box	FİYAT Price
RMK7115	120 mm	10 / 200 adet	

Paslanmaz Çelik



MİKRO YUVARLAK KARGABURUN

KOD NO Code No	ÖLÇÜ mm	PAKET/KOLİ Package/Box	FİYAT Price
RMK5115	120 mm	10 / 200 adet	

Paslanmaz Çelik



MİKRO KARGABURUN

KOD NO Code No	ÖLÇÜ mm	PAKET/KOLİ Package/Box	FİYAT Price
RMK9115	120 mm	10 / 200 adet	

Paslanmaz Çelik



MİKRO UZUN KARGABURUN

- Özel mafsal tasarımı.
- Kaynaklanmış sactan yay mekanizması.

KOD NO Code No	ÖLÇÜ mm	PAKET/KOLİ Package/Box	FİYAT Price
RMK6115	140 mm	10 / 200 adet	

Paslanmaz Çelik



MİKRO YASSI KARGABURUN DIŞLİ

- Özel mafsal tasarımı.
- Kaynaklanmış sactan yay mekanizması.

KOD NO Code No	ÖLÇÜ mm	PAKET/KOLİ Package/Box	FİYAT Price
RMK3115	120 mm	10 / 200 adet	

Paslanmaz Çelik



MİKRO YASSI KARGABURUN DÜZ

- Özel mafsal tasarımı.
- Kaynaklanmış sactan yay mekanizması.

KOD NO Code No	ÖLÇÜ mm	PAKET/KOLİ Package/Box	FİYAT Price
RMK2115	120 mm	10 / 200 adet	

Paslanmaz Çelik



MİKRO KARGABURUN DIŞLİ

- Özel mafsal tasarımı.
- Kaynaklanmış sactan yay mekanizması.

KOD NO Code No	ÖLÇÜ mm	PAKET/KOLİ Package/Box	FİYAT Price
RMK1115	120 mm	10 / 120 adet	

Paslanmaz Çelik



MİKRO KARGABURUN DÜZ

- Özel mafsal tasarımı.
- Kaynaklanmış sactan yay mekanizması.

KOD NO Code No	ÖLÇÜ mm	PAKET/KOLİ Package/Box	FİYAT Price
RMK4115	120 mm	10 / 200 adet	



MARANGOZ KERPETENLER

KOD NO Code No	ÖLÇÜ mm	PAKET/KOLİ Package/Box	FİYAT Price
RMK0200	200 mm	5 / 50 adet	



BETONCU KERPETENLER

KOD NO Code No	ÖLÇÜ mm	PAKET/KOLİ Package/Box	FİYAT Price
RBK0250	250 mm	5 / 50 adet	
RBK0280	280 mm	5 / 50 adet	



TEPE KESKİ

KOD NO Code No	ÖLÇÜ mm	PAKET/KOLİ Package/Box	FİYAT Price
RTK0160	160 mm	6 / 60 adet	
RTK0180	180 mm	6 / 60 adet	



KABLO SIYIRMA PENSESİ

KOD NO Code No	ÖLÇÜ mm	PAKET/KOLİ Package/Box	FİYAT Price
RKS0029	210 mm	10 / 60 adet	



KABLO KESME VE SIYIRMA PENSESİ

KOD NO Code No	ÖLÇÜ mm	PAKET/KOLİ Package/Box	FİYAT Price
RKK0042	170 mm	10 / 60 adet	



PABUÇ SIKMA PENSESİ

KOD NO Code No	ÖLÇÜ mm	PAKET/KOLİ Package/Box	FİYAT Price
RKS0062	247 mm	6 / 36 adet	

1	2	3
RKS0062 / 1	RKS0062 / 2	RKS0062 / 3
\$ 13,00	\$ 13,00	\$ 13,00



TELEFON VE NETWORK BAĞLANTI PENSESİ

- Saplar ergonomik yapıları sayesinde minimum basınç ile maksimum performans sağlar.
- Network ve telefon kabloları için sıyırma, kesme ve sıkıştırma kullanılır.

KOD NO Code No	ÖLÇÜ mm	PAKET/KOLİ Package/Box	FIYAT Price
RTP0068	195 mm	8 / 48 adet	
RTP0068P	6 P	6 / 36 adet	



PERÇİN TABANCASI - POP

- Hızlı ve güvenli perçinleme.
- 2,4 - 3,2 - 4,0 - 4,8 perçinler için
- Uçlar ve anahtar ürün gövdesindedir.
- Güçlü açma yaylı.
- Ergonomik sap.

KOD NO Code No	ÖLÇÜ mm	PAKET/KOLİ Package/Box	FIYAT Price
RPP2450	255 mm	1 / 50 adet	



TELEFON VE NETWORK BAĞLANTI PENSESİ

- Saplar ergonomik yapıları sayesinde minimum basınç ile maksimum performans sağlar.
- Network ve telefon kabloları için sıyırma, kesme ve sıkıştırma kullanılır.

KOD NO Code No	ÖLÇÜ mm	PAKET/KOLİ Package/Box	FIYAT Price
RTP0069	195 mm	8 / 48 adet	



PERÇİN TABANCASI - SOMUNLU

- M3, M4, Alüminyum, çelik, paslanmaz çelik perçinlerde kullanım.
- M5, Alüminyum ve çelik perçinlerde kullanım.
- M6, Alüminyum perçinlerde kullanım.
- Uçlar ve anahtar ürün gövdesindedir.
- Güçlü açma yaylı.
- Ergonomik sap, somunlu perçinlerde kullanılır.

KOD NO Code No	ÖLÇÜ mm	PAKET/KOLİ Package/Box	FIYAT Price
RVP3060	255 mm	1 / 36 adet	



KABLO SIYIRMA PENSESİ

- Özel olarak dizayn edilmiş sıkıştırma çeneleri kabloyu sıkıştırma süresince emniyetli bir şekilde tutar.
- Kalınlığı 0.2 - 0.5 mm² aralığındaki kablolarda mikro ayarlama düğmesi kullanılır.

KOD NO Code No	ÖLÇÜ mm	PAKET/KOLİ Package/Box	FIYAT Price
RKS0165	205 mm	10 / 60 adet	



PERÇİN TABANCASI - POP

- Hızlı ve güvenli perçinleme.
- Değişebilir uçlu 2,4-3,2-4,0-4,8 mm.
- Tüm malzemelerde 4.0 mm'e kadar perçinleme.
- Güçlü açma yaylı.
- Ergonomik sap.

KOD NO Code No	ÖLÇÜ mm	PAKET/KOLİ Package/Box	FIYAT Price
RPP0500	255 mm	10 / 40 adet	



Güç ve Hassasiyet

- ◆ Bükülmeye ve kırılmaya karşı yüksek dayanıklılığa sahip Chrome Vanadium çeliğinden üretilmiştir.
- ◆ Hobi kullanımdan, zorlu koşullar altında, sanayinin aradığı en üst kalite değerlerine uygundur.
- ◆ Uçlar, vida başlarına tam oturacak şekilde hassas ölçülerle işlenmiştir.

Ergonomi ve Geniş Ürün Gami

- ◆ İki bileşenli yüksek kaliteli saplar kaymaya karşı koruyuculuğu olup ergonomiktir ve yorulmadan çalışmayı sağlar.
- ◆ Keskin kenarları sıkıntısız 0'a indirilmiş ergonomik gövde tasarımı.
- ◆ Tek ya da setler veya modüller halinde temin edilebilir.

TORNAVIDALAR



RX SERİSİ TORNAVİDALAR

İstenilen tornavida modelini belirlemek için modern markalama tekniği kullanılmaktadır.



Mıknatıslı ve Siyah Oksitlenmiş Uç

Krom Vanadium Çeliğinden Süngü

Konforlu tutuş için tasarlanmış sap

RX SERİSİ KLEMENS TORNAVİDALAR

- Yüksek vasıflı chrome vanadium çelikten üretilmiştir.
- Uçlar, vida başına tam oturacak şekilde hassas ölçülerde işlenmiştir.

KOD NO Code No	ÖLÇÜ mm	PAKET/KOLİ Package/Box	FİYAT Price
RXK3075	3 x 75 mm	12 / 96 adet	
RXK3100	3 x 100 mm	12 / 96 adet	
RXK3125	3 x 125 mm	12 / 96 adet	
RXK4100	4 x 100 mm	12 / 96 adet	
RXK4125	4 x 125 mm	12 / 96 adet	
RXK5100	5 x 100 mm	12 / 96 adet	
RXK5125	5 x 125 mm	12 / 96 adet	
RXK5150	5 x 150 mm	12 / 96 adet	

RX SERİSİ DÜZ TORNAVİDALAR

- Yüksek vasıflı chrome vanadium çelikten üretilmiştir.
- Uçlar siyah oksit ile kaplamalı ve mıknatıslıdır.
- Uçlar, vida başına tam oturacak şekilde hassas ölçülerde işlenmiştir.

KOD NO Code No	ÖLÇÜ mm	PAKET/KOLİ Package/Box	FİYAT Price
RXD5100	5.0 x 100 mm	12 / 96 adet	
RXD5125	5.0 x 125 mm	12 / 96 adet	
RXD5150	5.0 x 150 mm	12 / 96 adet	
RXD5200	5.0 x 200 mm	12 / 96 adet	
RXD5300	5.0 x 300 mm	12 / 96 adet	
RXD6100	6.0 x 100 mm	12 / 96 adet	
RXD6125	6.5 x 125 mm	12 / 96 adet	
RXD6150	6.5 x 150 mm	12 / 96 adet	
RXD8150	8.0 x 150 mm	12 / 96 adet	
RXD8200	8.0 x 200 mm	12 / 96 adet	

RX SERİSİ YILDIZ TORNAVIDALAR

- Uçlar siyah oksit ile kaplamalı ve mıknatıslıdır.
- Uçlar, vida başına tam oturacak şekilde hassas ölçülerde işlenmiştir.

KOD NO Code No	ÖLÇÜ mm	PAKET/KOLİ Package/Box	FIYAT Price
RXY3080	PH0 x 80 mm	12 / 96 adet	
RXY3100	PH0 x 100 mm	12 / 96 adet	
RXY3125	PH0 x 125 mm	12 / 96 adet	
RXY4100	PH1 x 100 mm	12 / 96 adet	
RXY4125	PH1 x 125 mm	12 / 96 adet	
RXY5100	PH1 x 100 mm	12 / 96 adet	
RXY5125	PH1 x 125 mm	12 / 96 adet	
RXY5150	PH1 x 150 mm	12 / 96 adet	
RXY5200	PH1 x 200 mm	12 / 96 adet	
RXY5300	PH1 x 300 mm	12 / 96 adet	
RXY6100	PH2 x 100 mm	12 / 96 adet	
RXY6125	PH2 x 125 mm	12 / 96 adet	
RXY6150	PH2 x 150 mm	12 / 96 adet	
RXY8150	PH3 x 150 mm	12 / 96 adet	



RX SERİSİ DELİKLİ TORX TORNAVIDALAR

- Yüksek vasıflı chrome vanadium çelikten üretilmiştir.
- Uçlar, vida başına tam oturacak şekilde hassas ölçülerde işlenmiştir.

KOD NO Code No	ÖLÇÜ mm	PAKET/KOLİ Package/Box	FIYAT Price
RXT1010	T10 x 80 mm	12 / 96 adet	
RXT1015	T15 x 80 mm	12 / 96 adet	
RXT1020	T20 x 100 mm	12 / 96 adet	
RXT1025	T25 x 100 mm	12 / 96 adet	
RXT1027	T27 x 115 mm	12 / 96 adet	
RXT1030	T30 x 115 mm	12 / 96 adet	



RX SERİSİ TORX TORNAVIDALAR

- Uçlar siyah oksit ile kaplamalı ve mıknatıslıdır.
- Uçlar, vida başına tam oturacak şekilde hassas ölçülerde işlenmiştir.

KOD NO Code No	ÖLÇÜ mm	PAKET/KOLİ Package/Box	FIYAT Price
RXT0010	T10 x 80 mm	12 / 96 adet	
RXT0015	T15 x 80 mm	12 / 96 adet	
RXT0020	T20 x 100 mm	12 / 96 adet	
RXT0025	T25 x 100 mm	12 / 96 adet	
RXT0027	T27 x 115 mm	12 / 96 adet	
RXT0030	T30 x 115 mm	12 / 96 adet	





RX SERİSİ POZİDRİV TORNAVİDALAR



- Uçlar siyah oksit ile kaplamalı ve mıknatıslıdır.
- Uçlar, vida başına tam oturacak şekilde hassas ölçülerde işlenmiştir.

KOD NO Code No	ÖLÇÜ mm	PAKET/KOLİ Package/Box	FİYAT Price
RXZ3060	PZ0 x60 mm	12 / 96 adet	
RXZ5080	PZ1 x80 mm	12 / 96 adet	
RXZ6100	PZ2 x100 mm	12 / 96 adet	
RXZ6150	PZ2 x150 mm	12 / 96 adet	



RX SERİSİ TOPAÇ DÜZ TORNAVİDALAR



- Yüksek vasıflı chrome vanadium çelikten üretilmiştir.
- Uçlar, vida başına tam oturacak şekilde hassas ölçülerde işlenmiştir.
- Uçlar siyah oksit ile kaplamalı ve mıknatıslıdır.

KOD NO Code No	ÖLÇÜ mm	PAKET/KOLİ Package/Box	FİYAT Price
RXD6045	6.0 x 45 mm	12 / 96 adet	



RX SERİSİ TOPAÇ YILDIZ TORNAVİDALAR



- Yüksek vasıflı chrome vanadium çelikten üretilmiştir.
- Uçlar, vida başına tam oturacak şekilde hassas ölçülerde işlenmiştir.
- Uçlar siyah oksit ile kaplamalı ve mıknatıslıdır.

KOD NO Code No	ÖLÇÜ mm	PAKET/KOLİ Package/Box	FİYAT Price
RXY5045	PH1x45 mm	12 / 96 adet	
RXY6045	PH2x45 mm	12 / 96 adet	



RX SERİSİ TOPAÇ POZİDRİV TORNAVİDALAR



- Yüksek vasıflı chrome vanadium çelikten üretilmiştir.
- Uçlar, vida başına tam oturacak şekilde hassas ölçülerde işlenmiştir.
- Uçlar siyah oksit ile kaplamalı ve mıknatıslıdır.

KOD NO Code No	ÖLÇÜ mm	PAKET/KOLİ Package/Box	FİYAT Price
RXZ5045	PZ1x45 mm	12 / 96 adet	
RXZ6045	PZ2x45 mm	12 / 96 adet	

RX SERİSİ LOKMA TORNAVİDALAR

- Yüksek vasıflı chrome vanadium çelikten üretilmiştir.
- Uçlar siyah oksit ile kaplamalı ve mıknatıslıdır.
- Uçlar, vida başına tam oturacak şekilde hassas ölçülerde işlenmiştir.

KOD NO Code No	ÖLÇÜ mm	PAKET/KOLİ Package/Box	FIYAT Price
RXL1005	5.5 x 125 mm	12 / 120 adet	
RXL1006	6 x 125 mm	12 / 120 adet	
RXL1007	7 x 125 mm	12 / 120 adet	
RXL1008	8 x 125 mm	12 / 120 adet	
RXL1009	9 x 125 mm	12 / 120 adet	
RXL1010	10 x 125 mm	12 / 120 adet	
RXL1011	11 x 125 mm	12 / 120 adet	
RXL1012	12 x 125 mm	12 / 120 adet	
RXL1013	13 x 125 mm	12 / 120 adet	

**RX SERİSİ FLEX LOKMA TORNAVİDA**

- Bükülebilir güçlü şaft.
- Dar çalışma alanlarında vidalama yapmayı sağlar

KOD NO Code No	Ölçü mm	PAKET/KOLİ Package/Box	FIYAT Price
RXF1006	6 x 175mm	1 / 24 adet	
RXF1007	7 x 175mm	1 / 24 adet	
RXF1008	8 x 175mm	1 / 24 adet	
RXF1010	10 x 175mm	1 / 24 adet	

**BITS TUTUCU TORNAVİDA**

- 1/4 Btis uçlar ile kullanılır.
- Yüksek vasıflı Chrome Vanadium Çeliğinden üretilmiştir.

KOD NO Code No	Ölçü mm	PAKET/KOLİ Package/Box	FIYAT Price
RBT0115	115mm	1 / 24 adet	





RX SERİSİ TORNAVİDA SETİ

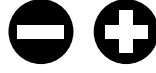

- Yüksek vasıflı chrome vanadium çelikten üretilmiştir
- Sertleştirilmiş parlak krom kaplamalıdır.
- Uçlar, vida başına tam oturacak şekilde hassas ölçülerde işlenmiştir.
- Uçlar siyah oksit ile kaplamalı ve mıknatıslıdır.
- İÇERİK:

⊕ PH1x100, PH2x100 ⊖ 3.0x75, 4.0x100, 5.0x125, 6.5x150

KOD NO Code No	İÇERİK Details	PAKET/KOLİ Package/Box	FIYAT Price
RXS6000	6 pcs	1 / 24 adet	

RX SERİSİ TORNAVİDA SETİ

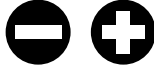

- İÇERİK: Kontrol Kalem

⊕ PH1x100, PH2x100 ⊖ 3.0x75, 4.0x100, 5.0x125, 6.5x150

KOD NO Code No	İÇERİK Details	PAKET/KOLİ Package/Box	FIYAT Price
RXS7000	7 pcs	1 / 24 adet	

RX SERİSİ TORX TORNAVİDA SETİ

- İÇERİK:

⊕ T10, T15, T20, T25, T27, T30



KOD NO Code No	İÇERİK Details	PAKET/KOLİ Package/Box	FIYAT Price
RXT6000	6 pcs	1 / 24 adet	

RX SERİSİ DELİKLİ TORX TORNAVİDA SETİ

- İÇERİK:

⊕ T10, T15, T20, T25, T27, T30

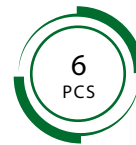

KOD NO Code No	İÇERİK Details	PAKET/KOLİ Package/Box	FIYAT Price
RXT6100	6 pcs	1 / 24 adet	

RX SERİSİ LOKMA TORNAVİDA SETİ



• İÇERİK:

- 6.0x125, 7.0x125, 8.0x125, 10.0x125, 13.0x125 mm

KOD NO Code No	İÇERİK Details	PAKET/KOLİ Package/Box	FIYAT Price
RXL5000	5 pcs	1 / 24 adet	

RX SERİSİ DÜZ TORNAVİDA SETİ



• İÇERİK:

- 3.0x80, 4.0x100, 5.0x125, 5.0x150, 6.0x100, 6.5x150



KOD NO Code No	İÇERİK Details	PAKET/KOLİ Package/Box	FIYAT Price
RXS6200	6 pcs	1 / 24 adet	

RX SERİSİ YILDIZ TORNAVİDA SETİ



• İÇERİK:

- 3.0x100, 4.0x100, 5.0x125, 6.0x100, 6.0x125, 6.0x150



KOD NO Code No	İÇERİK Details	PAKET/KOLİ Package/Box	FIYAT Price
RXS6300	6 pcs	1 / 24 adet	

RX SERİSİ 3'LÜ TORNAVİDA SETİ

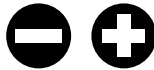

- Yüksek vasıflı chrome vanadium çelikten üretilmiştir
- Sertleştirilmiş parlak krom kaplamalıdır.
- Uçlar, vida başına tam oturacak şekilde hassas ölçülerde işlenmiştir.
- Uçlar siyah oksit ile kaplamalı ve mıknatıslıdır.

İÇERİK:

- YILDIZ TORNAVİDA
- DÜZ TORNAVİDA
- KONTROL KALEMİ

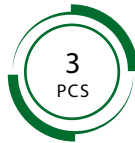

KOD NO Code No	İÇERİK Details	PAKET/KOLİ Package/Box	FIYAT Price
RXS3000	3 pcs	1 / 24 adet	

RX SERİSİ POZIDRİV TORNAVİDA SETİ

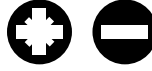

• İÇERİK:

- 4.0x100, 5.0x125, 6.5x150
- PZ0x60, PZ1x80, PZ2x100

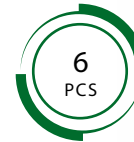

KOD NO Code No	İÇERİK Details	PAKET/KOLİ Package/Box	FIYAT Price
RXS6500	6 pcs	1 / 24 adet	



Mıknatıslı ve Siyah Oksitlenmiş Uç

Krom Vanadium Çeliğinden Süngü

RS SERİSİ KLEMENS TORNAVİDALAR



- Yüksek vasıflı chrome vanadium çelikten üretilmiştir.
- Uçlar, vida başına tam oturacak şekilde hassas ölçülerde işlenmiştir.

KOD NO Code No	ÖLÇÜ mm	PAKET/KOLİ Package/Box	FİYAT Price
RSK3075	3 x 75 mm	12 / 96 adet	
RSK3100	3 x 100 mm	12 / 96 adet	
RSK3125	3 x 125 mm	12 / 96 adet	
RSK4100	4 x 100 mm	12 / 96 adet	
RSK4125	4 x 125 mm	12 / 96 adet	
RSK5100	5 x 100 mm	12 / 96 adet	
RSK5125	5 x 125 mm	12 / 96 adet	
RSK5150	5 x 150 mm	12 / 96 adet	



RS SERİSİ DÜZ TORNAVİDALAR



- Yüksek vasıflı chrome vanadium çelikten üretilmiştir.
- Uçlar siyah oksit ile kaplamalı ve mıknatıslıdır.
- Uçlar, vida başına tam oturacak şekilde hassas ölçülerde işlenmiştir.

KOD NO Code No	ÖLÇÜ mm	PAKET/KOLİ Package/Box	FİYAT Price
RSD5100	5.0 x 100 mm	12 / 96 adet	
RSD5125	5.0 x 125 mm	12 / 96 adet	
RSD5150	5.0 x 150 mm	12 / 96 adet	
RSD5200	5.0 x 200 mm	12 / 96 adet	
RSD5300	5.0 x 300 mm	12 / 96 adet	
RSD6100	6.0 x 100 mm	12 / 96 adet	
RSD6125	6.5 x 125 mm	12 / 96 adet	
RSD6150	6.5 x 150 mm	12 / 96 adet	
RSD8200	8.0 x 200 mm	12 / 96 adet	





RS SERİSİ SİYAH TORNAVİDALAR

İstenilen tornavida modelini belirlemek için modern markalama tekniği kullanılmaktadır.



Konforlu tutuş için tasarlanmış sap

RS SERİSİ YILDIZ TORNAVİDALAR

- Uçlar siyah oksit ile kaplamalı ve mıknatıslıdır.
- Uçlar, vida başına tam oturacak şekilde hassas ölçülerde işlenmiştir.



KOD NO Code No	ÖLÇÜ mm	PAKET/KOLİ Package/Box	FİYAT Price
RSY3080	PH0 x 80 mm	12 / 96 adet	
RSY3100	PH0 x 100 mm	12 / 96 adet	
RSY3125	PH0 x 125 mm	12 / 96 adet	
RSY4100	PH1 x 100 mm	12 / 96 adet	
RSY4125	PH1 x 125 mm	12 / 96 adet	
RSY5100	PH1 x 100 mm	12 / 96 adet	
RSY5125	PH1 x 125 mm	12 / 96 adet	
RSY5150	PH1 x 150 mm	12 / 96 adet	
RSY5200	PH1 x 200 mm	12 / 96 adet	
RSY5300	PH1 x 300 mm	12 / 96 adet	
RSY6100	PH2 x 100 mm	12 / 96 adet	
RSY6125	PH2 x 125 mm	12 / 96 adet	
RSY6150	PH2 x 150 mm	12 / 96 adet	
RSY8150	PH3 x 150 mm	12 / 96 adet	



RS SERİSİ LOKMA TORNAVIDALAR



- Yüksek vasıflı chrome vanadium çelikten üretilmiştir.
- Uçlar, vida başına tam oturacak şekilde hassas ölçülerde işlenmiştir.



KOD NO Code No	ÖLÇÜ mm	PAKET/KOLI Package/Box	FIYAT Price
RSL1005	5.5 x 125 mm	12 / 120 adet	
RSL1006	6 x 125 mm	12 / 120 adet	
RSL1007	7 x 125 mm	12 / 120 adet	
RSL1008	8 x 125 mm	12 / 120 adet	
RSL1009	9 x 125 mm	12 / 120 adet	
RSL1010	10 x 125 mm	12 / 120 adet	
RSL1011	11 x 125 mm	12 / 120 adet	
RSL1012	12 x 125 mm	12 / 120 adet	
RSL1013	13 x 125 mm	12 / 120 adet	

RS SERİSİ DELİKLİ TORX TORNAVIDALAR



- Yüksek vasıflı chrome vanadium çelikten üretilmiştir.
- Uçlar, vida başına tam oturacak şekilde hassas ölçülerde işlenmiştir.



KOD NO Code No	ÖLÇÜ mm	PAKET/KOLI Package/Box	FIYAT Price
RST1010	T10 x 80 mm	12 / 96 adet	
RST1015	T15 x 80 mm	12 / 96 adet	
RST1020	T20 x 100 mm	12 / 96 adet	
RST1025	T25 x 100 mm	12 / 96 adet	
RST1027	T27 x 115 mm	12 / 96 adet	
RST1030	T30 x 115 mm	12 / 96 adet	

RS SERİSİ TORX TORNAVIDALAR



- Uçlar siyah oksit ile kaplamalı ve mıknatıslıdır.
- Uçlar, vida başına tam oturacak şekilde hassas ölçülerde işlenmiştir.



KOD NO Code No	ÖLÇÜ mm	PAKET/KOLI Package/Box	FIYAT Price
RST0010	T10 x 80 mm	12 / 96 adet	
RST0015	T15 x 80 mm	12 / 96 adet	
RST0020	T20 x 100 mm	12 / 96 adet	
RST0025	T25 x 100 mm	12 / 96 adet	
RST0027	T27 x 115 mm	12 / 96 adet	
RST0030	T30 x 115 mm	12 / 96 adet	

RS SERİSİ TOPAÇ DÜZ TORNAVİDA



- Yüksek vasıflı chrome vanadium çelikten üretilmiştir.
- Uçlar, vida başına tam oturacak şekilde hassas ölçülerde işlenmiştir.
- Uçlar siyah oksit ile kaplamalı ve mıknatıslıdır.

KOD NO Code No	ÖLÇÜ mm	PAKET/KOLİ Package/Box	FİYAT Price
RSD6045	6.0 x 45 mm	12 / 96 adet	



RS SERİSİ TOPAÇ YILDIZ TORNAVİDALAR



- Yüksek vasıflı chrome vanadium çelikten üretilmiştir.
- Uçlar, vida başına tam oturacak şekilde hassas ölçülerde işlenmiştir.
- Uçlar siyah oksit ile kaplamalı ve mıknatıslıdır.

KOD NO Code No	ÖLÇÜ mm	PAKET/KOLİ Package/Box	FİYAT Price
RSY5045	PH1x45 mm	12 / 96 adet	
RSY6045	PH2x45 mm	12 / 96 adet	



RS SERİSİ TOPAÇ POZİDRİV TORNAVİDALAR



- Yüksek vasıflı chrome vanadium çelikten üretilmiştir.
- Uçlar, vida başına tam oturacak şekilde hassas ölçülerde işlenmiştir.
- Uçlar siyah oksit ile kaplamalı ve mıknatıslıdır.

KOD NO Code No	ÖLÇÜ mm	PAKET/KOLİ Package/Box	FİYAT Price
RSZ5045	PZ1x45 mm	12 / 96 adet	
RSZ6045	PZ2x45 mm	12 / 96 adet	





RS SERİSİ POZİDRİV TORNAVİDALAR



- Uçlar siyah oksit ile kaplamalı ve mıknatıslıdır.
- Uçlar, vida başına tam oturacak şekilde hassas ölçülerde işlenmiştir.

KOD NO Code No	ÖLÇÜ mm	PAKET/KOLİ Package/Box	FIYAT Price
RSZ3060	PZ0 x60 mm	12 / 96 adet	
RSZ5080	PZ1 x80 mm	12 / 96 adet	
RSZ6100	PZ2 x100 mm	12 / 96 adet	
RSZ6150	PZ2 x150 mm	12 / 96 adet	



RS SERİSİ TORNAVİDA SETİ

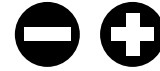

- Yüksek vasıflı chrome vanadium çelikten üretilmiştir
- Sertleştirilmiş parlak krom kaplamalıdır.
- Uçlar, vida başına tam oturacak şekilde hassas ölçülerde işlenmiştir.
- Uçlar siyah oksit ile kaplamalı ve mıknatıslıdır.
- İÇERİK:

⊕ PH1x100, PH2x100 ⊖ 3.0x75, 4.0x100, 5.0x125, 6.5x150

KOD NO Code No	İÇERİK Details	PAKET/KOLİ Package/Box	FIYAT Price
RSS6000	6 pcs	1 / 24 adet	



RS SERİSİ TORNAVİDA SETİ

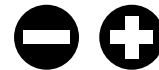

- Yüksek vasıflı chrome vanadium çelikten üretilmiştir
- Sertleştirilmiş parlak krom kaplamalıdır.
- Uçlar, vida başına tam oturacak şekilde hassas ölçülerde işlenmiştir.
- Uçlar siyah oksit ile kaplamalı ve mıknatıslıdır.
- İÇERİK: Kontrol Kalemi

⊕ PH1x100, PH2x100 ⊖ 3.0x75, 4.0x100, 5.0x125, 6.5x150

KOD NO Code No	İÇERİK Details	PAKET/KOLİ Package/Box	FIYAT Price
RSS7000	7 pcs	1 / 24 adet	

RS SERİSİ POZIDRIV TORNAVİDA SETİ

- Yüksek vasıflı chrome vanadium çelikten üretilmiştir
- Sertleştirilmiş parlak krom kaplamalıdır.
- Uçlar, vida başına tam oturacak şekilde hassas ölçülerde işlenmiştir.
- Uçlar siyah oksit ile kaplamalı ve mıknatıslıdır.
- İÇERİK:

⊖ 4.0x100, 5.0x125, 6.5x150 ⊕ PZ0x60, PZ1x80, PZ2x100

KOD NO Code No	İÇERİK Details	PAKET/KOLİ Package/Box	FİYAT Price
RSS6500	6 pcs	1 / 24 adet	

RS SERİSİ TORX TORNAVİDA SETİ

- Yüksek vasıflı chrome vanadium çelikten üretilmiştir
- Sertleştirilmiş parlak krom kaplamalıdır.
- Uçlar, vida başına tam oturacak şekilde hassas ölçülerde işlenmiştir.
- Uçlar siyah oksit ile kaplamalı ve mıknatıslıdır.
- İÇERİK:

⊕ T10, T15, T20, T25, T27, T30

KOD NO Code No	İÇERİK Details	PAKET/KOLİ Package/Box	FİYAT Price
RST6000	6 pcs	1 / 24 adet	

RS SERİSİ LOKMA TORNAVİDA SETİ

- Yüksek vasıflı chrome vanadium çelikten üretilmiştir
- Sertleştirilmiş parlak krom kaplamalıdır.
- Uçlar, vida başına tam oturacak şekilde hassas ölçülerde işlenmiştir.
- İÇERİK:

⊙ 6.0x125, 7.0x125, 8.0x125, 10.0x125, 13.0x125 mm

KOD NO Code No	İÇERİK Details	PAKET/KOLİ Package/Box	FİYAT Price
RSL5000	5 pcs	1 / 24 adet	



ASETAT SAPLI DÜZ TORNAVİDALAR

- Yüksek vasıflı chrome vanadium çeliğinden üretilmiştir.
- İndüksiyonla sertleştirilmiş hassas işlenmiş uçlar.
- Darbeye dayanıklı selülozik asetat sap.

	ÖLÇÜ mm	PAKET/KOLİ Package/Box	FİYAT Price
RAD4125	4.0 x125 mm	12 / 96 adet	
RAD5125	5.0 x125 mm	12 / 96 adet	
RAD5150	5.0 x150 mm	12 / 96 adet	
RAD6100	6.5 x100 mm	12 / 96 adet	
RAD6125	6.5 x125 mm	12 / 96 adet	
RAD6200	6.5 x200 mm	12 / 96 adet	
RAD8150	8.0 x150 mm	12 / 96 adet	



ASETAT SAPLI YILDIZ TORNAVİDALAR

- Yüksek vasıflı chrome vanadium çeliğinden üretilmiştir.
- İndüksiyonla sertleştirilmiş hassas işlenmiş uçlar.
- Darbeye dayanıklı selülozik asetat sap.

KOD NO Code No	ÖLÇÜ mm	PAKET/KOLİ Package/Box	FİYAT Price
RAY3080	PH0x 80 mm	12 / 96 adet	
RAY4100	PH1x100 mm	12 / 96 adet	
RAY4125	PH1x125 mm	12 / 96 adet	
RAY5100	PH1x100 mm	12 / 96 adet	
RAY5125	PH1x125 mm	12 / 96 adet	
RAY6100	PH2x100 mm	12 / 96 adet	
RAY8150	PH3x150 mm	12 / 96 adet	



ASETAT SAPLI TORX TORNAVİDALAR

	ÖLÇÜ mm	PAKET/KOLİ Package/Box	FİYAT Price
RTX1007	T7 100 mm	12 / 96 adet	
RTX1010	T10 100 mm	12 / 96 adet	
RTX1015	T15 100 mm	12 / 96 adet	
RTX1020	T20 100 mm	12 / 96 adet	
RTX1027	T27 100 mm	12 / 96 adet	
RTX1040	T40 100 mm	12 / 96 adet	



ASETAT SAPLI LOKMA TORNAVİDALAR

- Uçlar, somun başına tam oturacak şekilde hassas ölçülerde işlenmiştir.

KOD NO Code No	ÖLÇÜ mm	PAKET/KOLİ Package/Box	FİYAT Price
RLT1205	5.5 125 mm	12 / 96 adet	
RLT1206	6 125 mm	12 / 96 adet	
RLT1207	7 125 mm	12 / 96 adet	
RLT1211	11 125 mm	12 / 96 adet	
RLT1213	13 125 mm	12 / 96 adet	



ASETAT SAPLI TORX TORNAVIDALAR

KOD NO Code No	ÖLÇÜ mm	PAKET/KOLİ Package/Box	FIYAT Price
RTX0010	T10 x 100 mm	12 / 96 adet	
RTX0015	T15 x 100 mm	12 / 96 adet	
RTX0025	T25 x 100 mm	12 / 96 adet	
RTX0027	T27 x 100 mm	12 / 96 adet	
RTX0030	T30 x 100 mm	12 / 96 adet	
RTX0040	T40 x 100 mm	12 / 96 adet	



ASETAT SAPLI TOPAÇ YILDIZ-POZİDRİV TORNAVIDA

- Yüksek vasıflı chrome vanadium çeliğinden üretilmiştir.
- Uçlar, vida başına tam oturacak şekilde hassas ölçülerde işlenmiştir.
- Darbeye dayanıklı selülozik asetat sap.

KOD NO Code No	ÖLÇÜ mm	PAKET/KOLİ Package/Box	FIYAT Price
RAY6045	PH2x45mm	12 / 96 adet	
RAZ6045	PZ2x45mm	12 / 96 adet	



ASETAT SAPLI TOPAÇ DÜZ TORNAVIDA

- Yüksek vasıflı chrome vanadium çeliğinden üretilmiştir.
- Uçlar, vida başına tam oturacak şekilde hassas ölçülerde işlenmiştir.
- Darbeye dayanıklı selülozik asetat sap.

KOD NO Code No	ÖLÇÜ mm	PAKET/KOLİ Package/Box	FIYAT Price
RAD6045	5.0x45 mm	12 / 96 adet	



ASETAT SAPLI TORNAVIDA SETİ

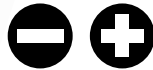

⊕ 0x60, 1.0x125, 2.0x150 ⊖ 3.0x80, 5.5x100, 6.5x150

KOD NO Code No	İÇERİK Details	PAKET/KOLİ Package/Box	FIYAT Price
RTS0604	6 pcs	4 / 24 adet	



ASETAT SAPLI TORX TORNAVIDA SETİ

- Torx başlı vidalar için kullanılır.
- Uçlar, vida başına tam oturacak şekilde hassas ölçülerde işlenmiştir.

⊕ T15, T20, T25, T27, T30

KOD NO Code No	İÇERİK Details	PAKET/KOLİ Package/Box	FIYAT Price
RTX1530	5 pcs	12 / 96 adet	



BİTS TUTUCU TORNAVIDA

KOD NO Code No	ÖLÇÜ mm	PAKET/KOLİ Package/Box	FİYAT Price
RBB1410	1/4"	12 / 72 adet	



RX SERİSİ FLEX MIKNATIS

Made in
Turkey

KOD NO Code No	ÖLÇÜ mm	PAKET/KOLİ Package/Box	FİYAT Price
RFM1600	1600 gr	12 / 120 adet	



RX SERİSİ FLEX MIKNATIS

Made in
Turkey

KOD NO Code No	ÖLÇÜ mm	PAKET/KOLİ Package/Box	FİYAT Price
RFM0600	600 gr	12 / 120 adet	



ELEKTRİKÇİ DÜZ TORNAVIDALAR



- Uçlar, vida başına tam oturacak şekilde hassas ölçülerde işlenmiştir.
- Uçlar siyah oksit ile kaplamalı ve mıknatıslıdır.

KOD NO Code No	ÖLÇÜ mm	PAKET/KOLİ Package/Box	FİYAT Price
RED3100	3.0 x100 mm	12 / 96 adet	
RED5125	5.0 x125 mm	12 / 96 adet	
RED6150	6.0 x150 mm	12 / 96 adet	



ELEKTRİKÇİ YILDIZ TORNAVIDALAR



- Uçlar, vida başına tam oturacak şekilde hassas ölçülerde işlenmiştir.
- Uçlar siyah oksit ile kaplamalı ve mıknatıslıdır.

KOD NO Code No	ÖLÇÜ mm	PAKET/KOLİ Package/Box	FİYAT Price
REY0075	PH0x75 mm	12 / 96 adet	
REY1100	PH1 x100 mm	12 / 96 adet	
REY2100	PH2 x100 mm	12 / 96 adet	



BÜYÜK KONTROL KALEMİ

- Yüksek vasıflı chrome vanadium çelikten üretilmiştir.
- Teşhir kutuda paketlenmiştir.
- Metal klipsli şeffaf açık mavi, selüloz asetat sap.
- 80-500V arasında gerilimi test eder.
- Parlak nikel kaplı düz uçlu süngü.

KOD NO Code No	ÖLÇÜ mm	PAKET/KOLİ Package/Box	FİYAT Price
RKK0190	190 mm	24 / 576 adet	



KÜÇÜK KONTROL KALEMİ

- Yüksek vasıflı chrome vanadium çelikten üretilmiştir.
- Teşhir kutuda paketlenmiştir.
- Metal klipsli şeffaf açık mavi, selüloz asetat sap.
- 80-500V arasında gerilimi test eder.
- Parlak nikel kaplı düz uçlu süngü.

KOD NO Code No	ÖLÇÜ mm	PAKET/KOLİ Package/Box	FİYAT Price
RKK0145	145 mm	24 / 576 adet	





MİKRO TORNAVIDALAR DÜZ



- Uçlar, vida başına tam oturacak şekilde hassas ölçülerde işlenmiştir.
- Mat krom kaplı sertleştirilmiş kaliteli chrome vanadium çeliği.



KOD NO Code No	ÖLÇÜ mm	PAKET/KOLİ Package/Box	FİYAT Price
RET1506	1,5 x 60 mm	12 / 480 adet	
RET2006	2,0 x 60 mm	12 / 480 adet	
RET2508	2,5 x 80 mm	12 / 480 adet	
RET3010	3,0 x 100 mm	12 / 480 adet	
RET3510	3,5 x 100 mm	12 / 480 adet	

MİKRO TORNAVIDALAR YILDIZ



- Uçlar, vida başına tam oturacak şekilde hassas ölçülerde işlenmiştir.
- Mat krom kaplı sertleştirilmiş kaliteli chrome vanadium çeliği.



KOD NO Code No	ÖLÇÜ mm	PAKET/KOLİ Package/Box	FİYAT Price
RET0060	PH00 x 60 mm	12 / 480 adet	
RET1080	PH1 x 80 mm	12 / 480 adet	
RET1150	PH1 x 150 mm	12 / 480 adet	

MİKRO TORNAVIDALAR TORX



- Uçlar, vida başına tam oturacak şekilde hassas ölçülerde işlenmiştir.
- Mat krom kaplı sertleştirilmiş kaliteli chrome vanadium çeliği.



KOD NO Code No	ÖLÇÜ mm	PAKET/KOLİ Package/Box	FİYAT Price
RET0560	T5 x 60 mm	12 / 480 adet	
RET0660	T6 x 60 mm	12 / 480 adet	
RET0760	T7 x 60 mm	12 / 480 adet	
RET0860	T8 x 60 mm	12 / 480 adet	
RET0960	T9 x 60 mm	12 / 480 adet	
RET1060	T10 x 60 mm	12 / 480 adet	

İNİ TORX TORNAVIDA SETİ



- Uçlar, vida başına tam oturacak şekilde hassas ölçülerde işlenmiştir.
- Mat krom kaplı sertleştirilmiş kaliteli chrome vanadium çeliği.

⊗ T5x60, T6x60, T7x60, T8x60, T9x60, T10x60

KOD NO Code No	İÇERİK Details	PAKET/KOLİ Package/Box	FİYAT Price
RTX6000	6 pcs	1 / 24 adet	



■ DIJİTAL KONTROL KALEMİ

- Yüksek vasıflı chrome vanadium çelikten üretilmiştir.
- Ergonomik yumuşak kavramalı, çift malzemedен üretilmiş sap.
- Uçlar vida başına tam oturacak şekilde hassas ölçülerde işlenmiştir.
- Bataryasız çalışır.

KOD NO Code No	ÖLÇÜ mm	PAKET/KOLİ Package/Box	FİYAT Price
RKK0101	12-250V	24 / 576 adet	



■ SAATÇİ TORNAVİDA SETİ

- Yüksek vasıflı chrome vanadium çelikten üretilmiştir.
 - Havalesiz kolay taşınabilen fonksiyonel plastik kutu.
 - Uçlar, vida başına tam oturacak şekilde hassas ölçülerde işlenmiştir.
- ⊕ PH0, PH1 ⊖ 1,4, 2.0, 2.4, 3 mm

KOD NO Code No	İÇERİK Details	PAKET/KOLİ Package/Box	FİYAT Price
RST0106	6 pcs	6 / 48 adet	



■ Z TORNAVİDALAR

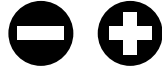

- Uçlar, vida başına tam oturacak şekilde hassas ölçülerde işlenmiştir.
- Mat krom kaplı sertleştirilmiş kaliteli chrome vanadium çeliği.

KOD NO Code No	ÖLÇÜ mm	PAKET/KOLİ Package/Box	FİYAT Price
RZT0150	5.0 x PH1	48 / 96 adet	
RZT0265	6.5 x PH2	48 / 96 adet	



7
PCS



CIRCIRLI TORNAVİDA UZUN

- Mat krom kaplı sertleştirilmiş kaliteli chrome vanadium çeliği.
- Çok amaçlı profesyonel kullanım için değişken olarak tasarlanmıştır.
- Havalesiz kolay taşınabilen fonksiyonel yapıları sayesinde tek başına 6 adetlik tornavida takımı işlevi görür

⊕ PH1, PH2 ⊕ T10, T15 ● 4.5, 6.0 mm

KOD NO Code No	İÇERİK Details	PAKET/KOLİ Package/Box	FİYAT Price
RCT0180	7 pcs	12 / 96 adet	

7
PCS



CIRCIRLI TOPAÇ TORNAVİDA

- Mat krom kaplı sertleştirilmiş kaliteli chrome vanadium çeliği.
- Çok amaçlı profesyonel kullanım için değişken olarak tasarlanmıştır.
- Havalesiz kolay taşınabilen fonksiyonel yapıları sayesinde tek başına 6 adetlik tornavida takımı işlevi görür

⊕ PH1, PH2 ⊕ T10, T15 ● 4.5, 6.0 mm

KOD NO Code No	İÇERİK Details	PAKET/KOLİ Package/Box	FİYAT Price
RCT0120	7 pcs	12 / 72 adet	

5
PCS



CIRCIRLI DEĞİŞKEN UÇLU TORNAVİDA

- Mat krom kaplı sertleştirilmiş kaliteli chrome vanadium çeliği.
- Ergonomik yumuşak kavramalı, çift malzemeden üretilmiş sap
- Çok amaçlı profesyonel kullanım için iki uçlu ve değişken olarak tasarlanmıştır.
- Havalesiz kolay taşınabilen fonksiyonel yapıları sayesinde tek başına 8 adetlik tornavida takımı işlevi görür.

⊕ PH0x3.0 mm ⊖ ⊕ PH2x6.0 mm ⊖
⊕ PH1x5.0 mm ⊖ ⊕ PH3x8.0 mm ⊖

KOD NO Code No	İÇERİK Details	PAKET/KOLİ Package/Box	FİYAT Price
RCT3615	5 pcs	6 / 54 adet	

3
PCS



DEĞİŞKEN UÇLU TORNAVİDA

- Ergonomik yumuşak kavramalı, çift malzemeden üretilmiş sap
- Çok amaçlı profesyonel kullanım için iki uçlu ve değişken olarak tasarlanmıştır.

⊕ PH1xPH2 ⊕ ⊖ 5.0x6.0 mm ⊖

KOD NO Code No	İÇERİK Details	PAKET/KOLİ Package/Box	FİYAT Price
RDT0041	3 pcs	10 / 60 adet	

BITS UÇLAR ve SETLER



Güç ve Hassasiyet

- ◆ Bükülmeye ve kırılmaya karşı yüksek dayanıklılığa sahip Chrome Vanadium çeliğinden üretilmiştir.
- ◆ Hobi kullanımdan, zorlu koşullar altında, sanayinin aradığı en üst kalite değerlerine uygundur.
- ◆ Uçlar, vida başlarına tam oturacak şekilde hassas ölçülerle işlenmiştir.

Ergonomi ve Geniş Ürün Gami

- ◆ İki bileşenli yüksek kaliteli saplar kaymaya karşı koruyuculuğu olup ergonomiktir ve yorulmadan çalışmayı sağlar.
- ◆ Keskin kenarları sıkıntısız 0'a indirilmiş ergonomik gövde tasarımı.
- ◆ Tek ya da setler veya modüller halinde temin edilebilir.

BİTS UÇLAR

Vida başlarına
tam oturan profil

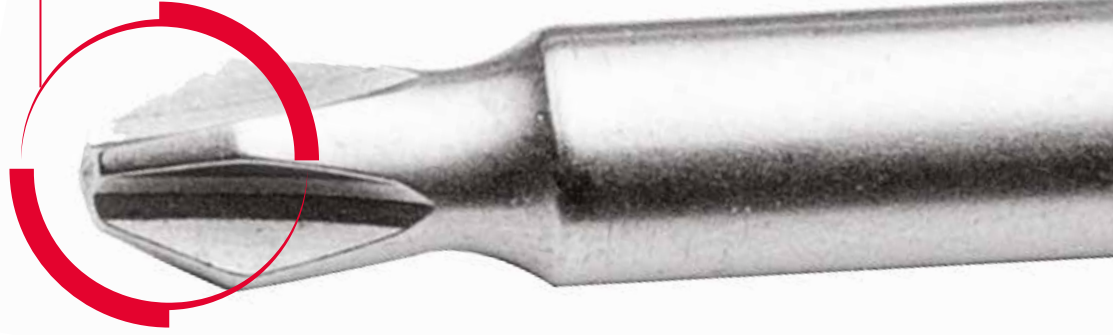

1/4"  50 mm 70 mm



1/4" ENDÜSTRİYEL YILDIZ BİTS UÇLAR

- Tamamı sertleştirilmiş JAPON çeliğinden mamül.
- Dayanma gücü yüksek 1/4" adaptöre uygundur.
- İndüksiyonla sertleştirilmiş ve hassas işlenmiş uçlar.

KOD NO Code No	ÖLÇÜ mm	PAKET/KOLİ Package/Box	FİYAT Price
REB1250	PH2 50 mm	25 / 1250 Adet	
REB1270	PH2 70 mm	10 / 1250 Adet	
REB1150	PH2 150 mm	10 / 600 Adet	

1/4"  25 mm



1/4" ENDÜSTRİYEL YILDIZ BİTS UÇLAR

- Tamamı sertleştirilmiş JAPON çeliğinden mamül.
- Dayanma gücü yüksek 1/4" adaptöre uygundur.
- İndüksiyonla sertleştirilmiş ve hassas işlenmiş uçlar.

KOD NO Code No	ÖLÇÜ mm	PAKET/KOLİ Package/Box	FİYAT Price
REB1225	PZ2 25 mm	40 / 1250 adet	

1/4"  25 mm



1/4" ENDÜSTRİYEL POZIDRİV BİTS UÇLAR

- Tamamı sertleştirilmiş JAPON çeliğinden mamül.
- Dayanma gücü yüksek 1/4" adaptöre uygundur.
- İndüksiyonla sertleştirilmiş ve hassas işlenmiş uçlar.

KOD NO Code No	ÖLÇÜ mm	PAKET/KOLİ Package/Box	FİYAT Price
REB2225	PH2 25 mm	40 / 1250 adet	

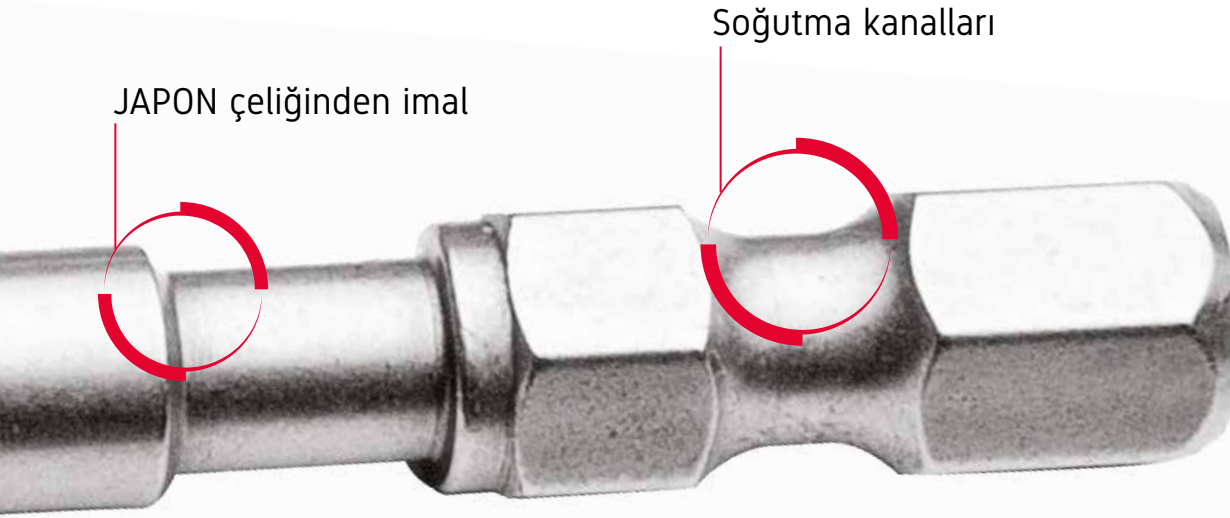

JAPON çeliğinden imal

Soğutma kanalları

1/4"



50 mm



1/4" ENDÜSTRİYEL TORX BITS UÇLAR

- Tamamı sertleştirilmiş JAPON çeliğinden mamül.
- Dayanma gücü yüksek 1/4" adaptöre uygundur.
- İndüksiyonla sertleştirilmiş ve hassas işlenmiş uçlar.

KOD NO Code No	ÖLÇÜ mm	PAKET/KOLİ Package/Box	FIYAT Price
RET5010	T10 50 mm	25 / 1250 adet	
RET5015	T15 50 mm	25 / 1250 adet	
RET5020	T20 50 mm	25 / 1250 adet	
RET5025	T25 50 mm	25 / 1250 adet	
RET5027	T27 50 mm	25 / 1250 adet	
RET5030	T30 50 mm	25 / 1250 adet	

1/4"



100 mm



1/4" ENDÜSTRİYEL TORX BITS UÇLAR

- Tamamı sertleştirilmiş JAPON çeliğinden mamül.
- Dayanma gücü yüksek 1/4" adaptöre uygundur.
- İndüksiyonla sertleştirilmiş ve hassas işlenmiş uçlar.

KOD NO Code No	ÖLÇÜ mm	PAKET/KOLİ Package/Box	FIYAT Price
RET1010	T10 100 mm	50 / 1250 adet	
RET1015	T15 100 mm	50 / 1250 adet	
RET1020	T20 100 mm	50 / 1250 adet	
RET1025	T25 100 mm	50 / 1250 adet	
RET1027	T27 100 mm	50 / 1250 adet	
RET1030	T30 100 mm	50 / 1250 adet	



1/4" 25 mm



1/4" YILDIZ BİTS UÇLAR

- Tamamı sertleştirilmiş chrome vanadium çeliğinden mamül.
- İndüksiyonla sertleştirilmiş ve hassas işlenmiş uçlar.

KOD NO Code No	ÖLÇÜ mm	PAKET/KOLİ Package/Box	FİYAT Price
RBU1025	PH1 25 mm	50 / 2500 adet	
RBU0025	PH2 25 mm	50 / 2500 adet	

1/4" 25 mm



1/4" POZIDRİV BİTS UÇLAR

- Tamamı sertleştirilmiş chrome vanadium çeliğinden mamül.
- İndüksiyonla sertleştirilmiş ve hassas işlenmiş uçlar.

KOD NO Code No	ÖLÇÜ mm	PAKET/KOLİ Package/Box	FİYAT Price
RBU2025	PZ1 25 mm	50 / 2500 adet	

1/4" 25 mm



1/4" ALLEN BİTS UÇLAR INCH

KOD NO Code No	ÖLÇÜ mm	PAKET/KOLİ Package/Box	FİYAT Price
RAI0180	1/8" 25 mm	50 / 2500 adet	
RAI0964	9/64" 25 mm	50 / 2500 adet	
RAI0532	5/32" 25 mm	50 / 2500 adet	
RAI0316	3/16" 25 mm	50 / 2500 adet	
RAI0732	7/32" 25 mm	50 / 2500 adet	

1/4" 25 mm



1/4" ALLEN BİTS UÇLAR

KOD NO Code No	ÖLÇÜ mm	PAKET/KOLİ Package/Box	FİYAT Price
RBA2503	3 mm 25 mm	50 / 2500 adet	
RBA2505	5 mm 25 mm	50 / 2500 adet	
RBA2506	6 mm 25 mm	50 / 2500 adet	

1/4" 25 mm



1/4" TORX BİTS UÇLAR

KOD NO Code No	ÖLÇÜ mm	PAKET/KOLİ Package/Box	FİYAT Price
RBT0008	T8 25 mm	50 / 2500 adet	
RBT0009	T9 25 mm	50 / 2500 adet	
RBT0010	T10 25 mm	50 / 2500 adet	
RBT0015	T15 25 mm	50 / 2500 adet	
RBT0020	T20 25 mm	50 / 2500 adet	
RBT0025	T25 25 mm	50 / 2500 adet	
RBT0027	T27 25 mm	50 / 2500 adet	
RBT0030	T30 25 mm	50 / 2500 adet	
RBT0040	T40 25 mm	50 / 2500 adet	

1/4" 25 mm



1/4" DELİKLİ TORX BİTS UÇLAR

KOD NO Code No	ÖLÇÜ mm	PAKET/KOLİ Package/Box	FİYAT Price
RBT1010	T10 25 mm	50 / 2500 adet	
RBT1015	T15 25 mm	50 / 2500 adet	
RBT1020	T20 25 mm	50 / 2500 adet	
RBT1025	T25 25 mm	50 / 2500 adet	
RBT1027	T27 25 mm	50 / 2500 adet	
RBT1030	T30 25 mm	50 / 2500 adet	
RBT1040	T40 25 mm	50 / 2500 adet	



1/4" 25 mm



1/4" 5 KÖŞE BİTS UÇLAR

KOD NO Code No	ÖLÇÜ mm	PAKET/KOLİ Package/Box	FİYAT Price
RBT2010	T10 25 mm	50 / 2500 adet	
RBT2015	T15 25 mm	50 / 2500 adet	
RBT2020	T20 25 mm	50 / 2500 adet	
RBT2025	T25 25 mm	50 / 2500 adet	
RBT2027	T27 25 mm	50 / 2500 adet	
RBT2030	T30 25 mm	50 / 2500 adet	
RBT2040	T40 25 mm	50 / 2500 adet	

1/4" 25 mm



1/4" 12 KÖŞE BİTS UÇLAR - XZN

- Tamamı sertleştirilmiş chrome vanadium çeliğinden mamül.
- İndüksiyonla sertleştirilmiş ve hassas işlenmiş uçlar.

KOD NO Code No	ÖLÇÜ mm	PAKET/KOLİ Package/Box	FİYAT Price
RBS00M4	M4 25 mm	50 / 2500 adet	
RBS00M5	M5 25 mm	50 / 2500 adet	
RBS00M6	M6 25 mm	50 / 2500 adet	
RBS00M8	M8 25 mm	50 / 2500 adet	

1/4" 25 mm



1/4" TİTANYUM YILDIZ BİTS UÇLAR

- Tamamı sertleştirilmiş chrome vanadium çeliğinden mamül.
- İndüksiyonla sertleştirilmiş ve hassas işlenmiş uçlar.

KOD NO Code No	ÖLÇÜ mm	PAKET/KOLİ Package/Box	FİYAT Price
RBU3025	PH1 25 mm	50 / 2500 adet	
RBU0425	PH2 25 mm	50 / 2500 adet	

1/4" 25 mm



1/4" DÜZ BİTS UÇLAR

- Tamamı sertleştirilmiş chrome vanadium çeliğinden mamül.
- İndüksiyonla sertleştirilmiş ve hassas işlenmiş uçlar.

KOD NO Code No	ÖLÇÜ mm	PAKET/KOLİ Package/Box	FİYAT Price
RBU0325	SL5.5 25 mm	50 / 2500 adet	

1/4" 25 mm

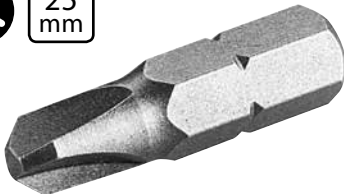

1/4" TRI-WING BİTS UÇLAR

KOD NO Code No	ÖLÇÜ mm	PAKET/KOLİ Package/Box	FİYAT Price
RBY0125	TW1 25 mm	50 / 2500 adet	
RBY0225	TW2 25 mm	50 / 2500 adet	
RBY0325	TW3 25 mm	50 / 2500 adet	
RBY0425	TW4 25 mm	50 / 2500 adet	
RBY0525	TW5 25 mm	50 / 2500 adet	

1/4" 25 mm



1/4" TORQ-SET BİTS UÇLAR

KOD NO Code No	ÖLÇÜ mm	PAKET/KOLİ Package/Box	FİYAT Price
RTS0060	No 6 25 mm	50 / 2500 adet	
RTS0080	No 8 25 mm	50 / 2500 adet	



1/4"  50 mm 70 mm 100 mm 150 mm



1/4" YILDIZ BİTS UÇLAR

KOD NO Code No	ÖLÇÜ mm	PAKET/KOLİ Package/Box	FİYAT Price
RBU1050	PH1 50 mm	30 / 1500 adet	
RBU0050	PH2 50 mm	30 / 1500 adet	
RBU4050	PH3 50 mm	30 / 1500 adet	
RBU1070	PH1 70mm	25/1250 adet	
RBU0070	PH2 70mm	25/1250 adet	
RBU3070	PH3 70mm	25/1250 adet	
RBU1100	PH1 100mm	10/500 adet	
RBU0100	PH2 100mm	10/500 adet	
RBU1150	PH1 150mm	10/500 adet	
RBU0150	PH2 150mm	10/500 adet	

1/4"  50 mm 70 mm 100 mm 150 mm



1/4" POZIDRİV BİTS UÇLAR

KOD NO Code No	ÖLÇÜ mm	PAKET/KOLİ Package/Box	FİYAT Price
RBU2050	PZ1 50 mm	30 / 1500 adet	
RBU0250	PZ2 50 mm	30 / 1500 adet	
RBZ5050	PZ3 50 mm	30 / 1500 adet	
RBZ3070	PZ3 70mm	25/1250 adet	
RBZ1100	PZ1 100mm	10/500 adet	
RBZ1150	PZ1 150mm	10/500 adet	
RBZ0150	PZ2 150mm	10/500 adet	

1/4"  50 mm 70 mm



1/4" TORX BİTS UÇLAR

KOD NO Code No	ÖLÇÜ mm	PAKET/KOLİ Package/Box	FİYAT Price
RBT5015	T15 50 mm	30 / 1500 adet	
RBT5020	T20 50 mm	30 / 1500 adet	
RBT5025	T25 50 mm	30 / 1500 adet	
RBT5027	T27 50 mm	30 / 1500 adet	
RBT5030	T30 50 mm	30 / 1500 adet	
RBT5040	T40 50 mm	30 / 1500 adet	
RBT7010	T10 70 mm	25 / 1500 adet	
RBT7015	T15 70 mm	25 / 1500 adet	
RBT7020	T20 70 mm	25 / 1500 adet	
RBT7025	T25 70 mm	25 / 1500 adet	
RBT7030	T30 70 mm	25 / 1500 adet	

1/4"  50 mm



1/4" ALLEN BİTS UÇLAR

KOD NO Code No	ÖLÇÜ mm	PAKET/KOLİ Package/Box	FİYAT Price
RBA5003	3 mm 50 mm	30 / 1500 adet	
RBA5004	4 mm 50 mm	30 / 1500 adet	
RBA5005	5 mm 50 mm	30 / 1500 adet	
RBA5006	6 mm 50 mm	30 / 1500 adet	



1/4"  50 mm

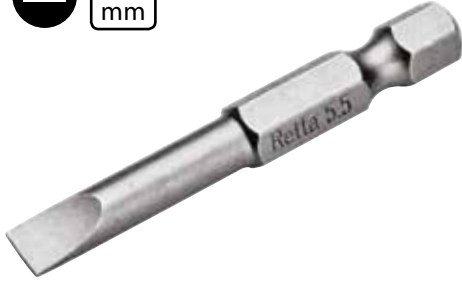

1/4" DÜZ BİTS UÇLAR

- Tamamı sertleştirilmiş chrome vanadium çeliğinden mamül.
- İndüksiyonla sertleştirilmiş ve hassas işlenmiş uçlar.

KOD NO Code No	ÖLÇÜ mm	PAKET/KOLİ Package/Box	FIYAT Price
RBU0350	SL5.5 50 mm	50 / 2500 adet	

1/4"  25 mm



1/4" KARE BİTS UÇLAR

KOD NO Code No	ÖLÇÜ mm	PAKET/KOLİ Package/Box	FIYAT Price
RBK0125	No1 25 mm	50 / 2500 adet	
RBK0225	No2 25 mm	50 / 2500 adet	
RBK0325	No3 25 mm	50 / 2500 adet	

1/4"  50 mm



1/4" TİTANYUM YILDIZ BİTS UÇLAR

KOD NO Code No	ÖLÇÜ mm	PAKET/KOLİ Package/Box	FIYAT Price
RBU3050	PH1 50 mm	30 / 1500 adet	
RBU0450	PH2 50 mm	30 / 1500 adet	

1/4"  25 mm



1/4" ALÇIPAN/PİMAPEN BİTS UÇ

KOD NO Code No	ÖLÇÜ mm	PAKET/KOLİ Package/Box	FIYAT Price
RAU0025	25 mm	20 / 2500 adet	

BİTS SET - BİTS TUTUCULU

- İÇERİK: Bits tutucu, PH2 70 mm ve PZ2 70 mm bits uç PH1, PH2, PH3, PZ1, PZ2, PZ3, T15, T20, T25, SL4.5, SL5.5, SL6.5

KOD NO Code No	İÇERİK Details	PAKET/KOLİ Package/Box	FIYAT Price
RBS0015	15 pcs	6 / 60 adet	

15
PCS



10
PCS

BİTS SET

- Tamamı sertleştirilmiş chrome vanadium çeliğinden mamül.
- İndüksiyonla sertleştirilmiş ve hassas işlenmiş uçlar.
- Yaylı fonksiyonel plastik ambalaj.

⊕ PH1, 2xPH2, PH3 ⊖ 5.5, 6.5 mm ⊕ PZ1, 2xPZ2, PZ3

KOD NO Code No	İÇERİK Details	PAKET/KOLİ Package/Box	FİYAT Price
RBS5030	10 pcs	25 / 60 adet	

10
PCS

TORX BİTS SET

- Tamamı sertleştirilmiş chrome vanadium çeliğinden mamül.
- İndüksiyonla sertleştirilmiş ve hassas işlenmiş uçlar.
- Yaylı fonksiyonel plastik ambalaj.

⊕ T5, T7, T8, T9, T10, T15, T20, T25, T27, T30

KOD NO Code No	İÇERİK Details	PAKET/KOLİ Package/Box	FİYAT Price
RBS5530	10 pcs	25 / 60 adet	

10
PCS

TİTANYUM BİTS SET

- Tamamı sertleştirilmiş chrome vanadium çeliğinden mamül.
- İndüksiyonla sertleştirilmiş ve hassas işlenmiş uçlar.
- Yaylı fonksiyonel plastik ambalaj.

⊕ PH1, 2xPH2, PH3 ⊖ 5.5, 6.5 mm ⊕ PZ1, 2xPZ2, PZ3

KOD NO Code No	İÇERİK Details	PAKET/KOLİ Package/Box	FİYAT Price
RBS6030	10 pcs	25 / 60 adet	



10MM TORX BİTS UÇLAR

- Tamamı sertleştirilmiş chrome vanadium çeliğinden mamül.
- İndüksiyonla sertleştirilmiş ve hassas işlenmiş uçlar.

KOD NO Code No	ÖLÇÜ mm	PAKET/KOLİ Package/Box	FİYAT Price
RBT3020	T20 30 mm	20 / 1000 adet	
RBT3025	T25 30 mm	20 / 1000 adet	
RBT3027	T27 30 mm	20 / 1000 adet	
RBT3030	T30 30 mm	20 / 1000 adet	
RBT3040	T40 30 mm	20 / 1000 adet	
RBT3045	T45 30 mm	20 / 1000 adet	
RBT3050	T50 30 mm	20 / 1000 adet	
RBT3055	T55 30 mm	20 / 1000 adet	
RBT3060	T60 30mm	20 / 1000 adet	

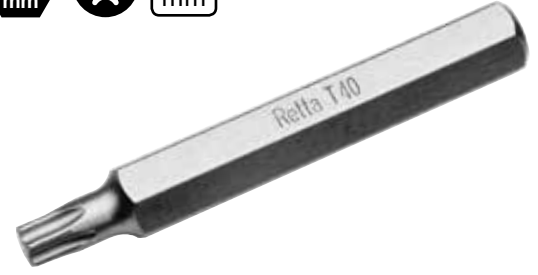

10MM TORX BİTS UÇLAR

- Tamamı sertleştirilmiş chrome vanadium çeliğinden mamül.
- İndüksiyonla sertleştirilmiş ve hassas işlenmiş uçlar.

KOD NO Code No	ÖLÇÜ mm	PAKET/KOLİ Package/Box	FİYAT Price
RBT7520	T20 75 mm	20 / 1000 adet	
RBT7525	T25 75 mm	20 / 1000 adet	
RBT7527	T27 75 mm	20 / 1000 adet	
RBT7530	T30 75 mm	20 / 1000 adet	
RBT7540	T40 75 mm	20 / 1000 adet	
RBT7545	T45 75 mm	20 / 1000 adet	
RBT7550	T50 75 mm	20 / 1000 adet	
RBT7555	T55 75 mm	20 / 1000 adet	
RBT7560	T60 75 mm	20 / 1000 adet	



10MM 12 KÖŞE BİTS UÇLAR - XZN

- Tamamı sertleştirilmiş chrome vanadium çeliğinden mamül.
- İndüksiyonla sertleştirilmiş ve hassas işlenmiş uçlar.

KOD NO Code No	ÖLÇÜ mm	PAKET/KOLİ Package/Box	FİYAT Price
RBT3005	M5 30 mm	20 / 1000 adet	
RBT3006	M6 30 mm	20 / 1000 adet	
RBT3008	M8 30 mm	20 / 1000 adet	
RBT3010	M10 30 mm	20 / 1000 adet	
RBT3012	M12 30 mm	15 / 1000 adet	



10MM 12 KÖŞE BİTS UÇLAR - XZN

- Tamamı sertleştirilmiş chrome vanadium çeliğinden mamül.
- İndüksiyonla sertleştirilmiş ve hassas işlenmiş uçlar.

KOD NO Code No	ÖLÇÜ mm	PAKET/KOLİ Package/Box	FİYAT Price
RBT7505	M5 75 mm	10 / 300 adet	
RBT7506	M6 75 mm	10 / 300 adet	
RBT7508	M8 75 mm	10 / 300 adet	
RBT7510	M10 75 mm	10 / 300 adet	
RBT7512	M12 75 mm	10 / 300 adet	



10 MM ALLEN BITS UÇLAR

- Tamamı sertleştirilmiş chrome vanadium çeliğinden mamül.
- İndüksiyonla sertleştirilmiş ve hassas işlenmiş uçlar.

KOD NO Code No	ÖLÇÜ mm	PAKET/KOLİ Package/Box	FİYAT Price
RBA3004	4mm 30 mm	20 / 1000 adet	
RBA3005	5mm 30 mm	20 / 1000 adet	
RBA3006	6mm 30 mm	20 / 1000 adet	
RBA3008	8mm 30 mm	20 / 1000 adet	
RBA3010	10mm 30 mm	20 / 1000 adet	
RBA3012	12mm 30 mm	15 / 750 adet	



10 MM ALLEN BITS UÇLAR

- Tamamı sertleştirilmiş chrome vanadium çeliğinden mamül.
- İndüksiyonla sertleştirilmiş ve hassas işlenmiş uçlar.

KOD NO Code No	ÖLÇÜ mm	PAKET/KOLİ Package/Box	FİYAT Price
RBA7504	4mm 75 mm	10 / 300 adet	
RBA7505	5mm 75 mm	10 / 300 adet	
RBA7506	6mm 75 mm	10 / 300 adet	
RBA7508	8mm 75 mm	10 / 300 adet	
RBA7510	10mm 75 mm	10 / 300 adet	
RBA7512	12mm 75 mm	10 / 120 adet	



10 MM RİBE BITS UÇLAR

- Tamamı sertleştirilmiş chrome vanadium çeliğinden mamül.
- İndüksiyonla sertleştirilmiş ve hassas işlenmiş uçlar.

KOD NO Code No	ÖLÇÜ mm	PAKET/KOLİ Package/Box	FİYAT Price
RBR3005	M5 30 mm	20 / 1000 adet	
RBR3006	M6 30 mm	20 / 1000 adet	
RBR3007	M7 30 mm	20 / 1000 adet	
RBR3008	M8 30 mm	20 / 1000 adet	
RBR3009	M9 30 mm	20 / 1000 adet	
RBR3010	M10 30 mm	20 / 1000 adet	
RBR3012	M12 30 mm	20 / 1000 adet	
RBR3014	M14 30 mm	20 / 1000 adet	
RBR3016	M16 30mm	20 / 1000 adet	



10 MM RİBE BITS UÇLAR

- Tamamı sertleştirilmiş chrome vanadium çeliğinden mamül.
- İndüksiyonla sertleştirilmiş ve hassas işlenmiş uçlar.

KOD NO Code No	ÖLÇÜ mm	PAKET/KOLİ Package/Box	FİYAT Price
RBR7505	M5 75 mm	10 / 300 adet	
RBR7506	M6 75 mm	10 / 300 adet	
RBR7507	M7 75 mm	10 / 300 adet	
RBR7508	M8 75 mm	10 / 300 adet	
RBR7509	M9 75 mm	10 / 300 adet	
RBR7510	M10 75 mm	10 / 300 adet	
RBR7512	M12 75 mm	10 / 300 adet	
RBR7514	M14 75 mm	10 / 300 adet	
RBR7516	M16 75 mm	10 / 300 adet	



1/4" BITS TUTUCULAR

- Chrome vanadium gövde.
- Miknatıslı çelik tutucu.

KOD NO Code No	ÖLÇÜ mm	PAKET/KOLİ Package/Box	FİYAT Price
RBT0260	60 mm	20 / 400 adet	
RBT0275	75 mm	20 / 400 adet	



1/4" SDS-PLUS BITS TUTUCU

- Chrome vanadium gövde.
- Miknatıslı çelik tutucu.

KOD NO Code No	ÖLÇÜ mm	PAKET/KOLİ Package/Box	FİYAT Price
RBT0780	80 mm	20 / 300 adet	



1/4" KİLİTLİ BITS TUTUCULAR

- Chrome vanadium gövde.
- Miknatıslı çelik tutucu.

KOD NO Code No	ÖLÇÜ mm	PAKET/KOLİ Package/Box	FİYAT Price
RBT0560	60 mm	20 / 400 adet	
RBT0575	75 mm	20 / 400 adet	



1/4" MIKNATISLI BITS TUTUCU

- Chrome vanadium gövde.
- Miknatıslı çelik tutucu.

KOD NO Code No	ÖLÇÜ mm	PAKET/KOLİ Package/Box	FİYAT Price
RBT0565	65 mm	6 / 60 adet	



1/4" 65 mm



1/4" SOMUN TUTUCULAR

- Chrome vanadium gövde.
- Miknatıslı çelik tutucu.

KOD NO Code No	ÖLÇÜ mm	PAKET/KOLİ Package/Box	FİYAT Price
RST0665	6mm 65 mm	10 / 500 adet	
RST0765	7mm 65 mm	10 / 500 adet	
RST1065	10mm 65 mm	6 / 300 adet	
RST1165	11mm 65 mm	4 / 200 adet	
RST1365	13mm 65 mm	4 / 200 adet	

1/4" 3/8" 1/2"
25 mm 50 mm 50 mm 50 mm



1/4" BITS ADAPTÖRLER

- Chrome vanadium gövde.
- 6 ve 12 köşe lokmaların, makine ile kullanımını sağlar.

KOD NO Code No	ÖLÇÜ mm	PAKET/KOLİ Package/Box	FİYAT Price
RBA1425	1/4" 25 mm	25 / 500 adet	
RBA1450	1/4" 50 mm	25 / 500 adet	
RBA3850	3/8" 50 mm	25 / 500 adet	
RBA1250	1/2" 50 mm	25 / 300 adet	

3
PCS



1/4" 50MM BITS ADAPTÖR SET

- Chrome vanadium gövde.
- 6 ve 12 köşe lokmaların, makine ile kullanımını sağlar.
- 1/4" 50 mm. 3/8" 50 mm. 1/2" 50 mm.

KOD NO Code No	İÇERİK Detalis	PAKET/KOLİ Package/Box	FİYAT Price
RBA1412	3 pcs	20 / 60 adet	

EKİÇ, KESKİ VE SDS ULAR

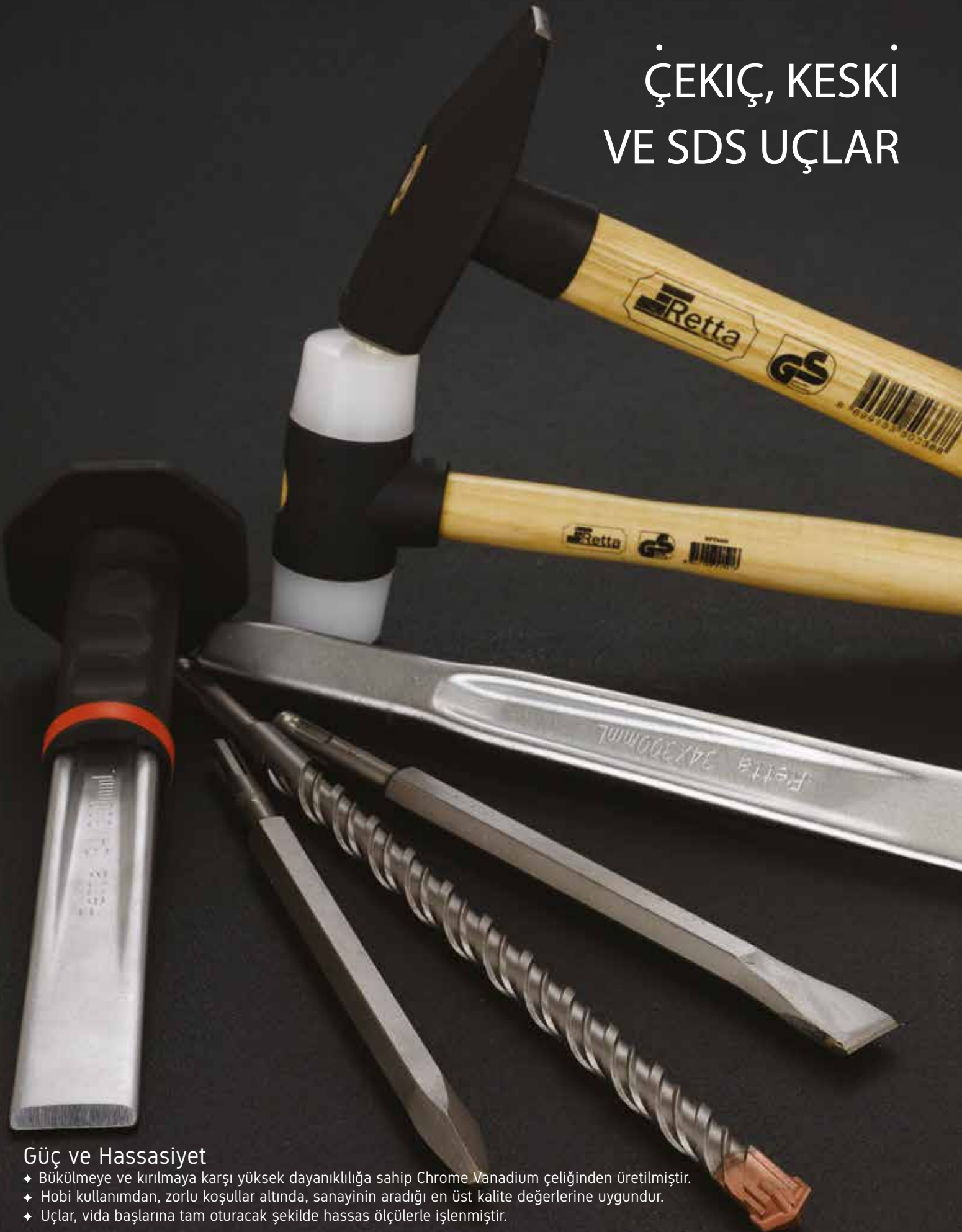

Gc ve Hassasiyet

- ◆ Bklmeye ve kırılmaya karşı yksek dayanıklılıęa sahip Chrome Vanadium elięinden retilmiřtir.
- ◆ Hobi kullanımdan, zorlu kořullar altında, sanayinin aradıęı en st kalite deęerlerine uygundur.
- ◆ Ular, vida bařlarına tam oturacak řekilde hassas llerle iřlenmiřtir.

Ergonomi ve Geniř rn Gamı

- ◆ İki bileřenli yksek kaliteli saplar kaymaya karşı koruyuculuęu olup ergonomiktir ve yorulmadan alıřmayı saęlar.
- ◆ Keskin kenarları sıkıntısız 0'a indirilmiř ergonomik gvde tasarım.
- ◆ Tek ya da setler veya modller halinde temin edilebilir.



AĞAÇ SAPLI TESVİYECİ ÇEKİÇLERİ

- Özellikle metallerde kullanım amaçlı tesviyeci çekiçler.
- Siyah kaplamalı sıcak dövülmüş hassas sertleştirilmiş ve tavlanmış özel alet çeliği kullanılarak üretilmiştir.
- Gövdeye özel bir metal kamayla sabitlenmiş kafa sayesinde rahat ve güvenli çalışma ortamı sağlar.

KOD NO Code No	ÖLÇÜ mm	PAKET/KOLİ Package/Box	FIYAT Price
RTC0100	100 gr.	12/ 120 adet	
RTC0200	200 gr.	12 / 72 adet	
RTC0300	300 gr.	12 / 72 adet	
RTC0500	500 gr.	12 / 72 adet	
RTC1000	1000 gr.	6 / 36 adet	
RTC1500	1500 gr.	6 / 36 adet	
RTC2000	2000 gr.	6 / 36 adet	





YASSI KESKİ

- Yüksek vasıflı chrome vanadium çeliğinden üretilmiştir.
- Kendisinden daha yumuşak metalleri kesmek, şekillendirmek ve kaldırmak için kullanılır.
- Tekrar bileyenebilir özellik.

KOD NO Code No	ÖLÇÜ mm	PAKET/KOLİ Package/Box	FİYAT Price
REK2015	150 mm	12 / 120 adet	
REK2620	200 mm	12 / 72 adet	
REK2925	250 mm	10 / 20 adet	
REK2930	300 mm	12 / 12 adet	



İNCE YASSI KESKİ

- Yüksek vasıflı chrome vanadium çeliğinden üretilmiştir.
- Kendisinden daha yumuşak metalleri kesmek, şekillendirmek ve kaldırmak için kullanılır.
- Tekrar bileyenebilir özellik.

KOD NO Code No	ÖLÇÜ mm	PAKET/KOLİ Package/Box	FİYAT Price
REK2624	240 mm	6 / 60 adet	



DÜZ PİM ZIMBA

KOD NO Code No	ÖLÇÜ mm	PAKET/KOLİ Package/Box	FİYAT Price
RPZ0215	2 mm x 150 mm	12 / 240 adet	
RPZ0315	3 mm x 150 mm	12 / 240 adet	
RPZ0415	4 mm x 150 mm	12 / 240 adet	
RPZ0515	5 mm x 150 mm	12 / 240 adet	
RPZ0615	6 mm x 150 mm	12 / 240 adet	
RPZ0815	8 mm x 150 mm	12 / 240 adet	



KESKİ KORUMALI

KOD NO Code No	ÖLÇÜ mm	PAKET/KOLİ Package/Box	FİYAT Price
REK2930K	300 mm	12 / 12 adet	



NOKTA PİM ZIMBA

KOD NO Code No	ÖLÇÜ mm	PAKET/KOLİ Package/Box	FİYAT Price
RNZ0412	4 mm x 120 mm	12 / 240 adet	
RNZ0512	5 mm x 120 mm	12 / 240 adet	



KONİK PİM ZIMBA

KOD NO Code No	ÖLÇÜ mm	PAKET/KOLİ Package/Box	FİYAT Price
RKZ0312	3 mm x 120 mm	12 / 240 adet	
RKZ0412	4 mm x 120 mm	12 / 240 adet	
RKZ0512	5 mm x 120 mm	12 / 240 adet	
RKZ0612	6 mm x 120 mm	12 / 240 adet	



TIRNAK KESKİ

- Yüksek vasıflı chrome vanadium çeliğinden üretilmiştir.
- Kendisinden daha yumuşak metalleri kesmek, şekillendirmek ve kaldırmak için kullanılır.
- Tekrar bileylenebilir özellik.

KOD NO Code No	ÖLÇÜ mm	PAKET/KOLİ Package/Box	FIYAT Price
RTK0712	7 mm x 150 mm	12 / 240 adet	



TESVİYECİ KESKİ

- Yüksek vasıflı chrome vanadium çeliğinden üretilmiştir.
- Kendisinden daha yumuşak metalleri kesmek, şekillendirmek ve kaldırmak için kullanılır.
- Tekrar bileylenebilir özellik.

KOD NO Code No	ÖLÇÜ mm	PAKET/KOLİ Package/Box	FIYAT Price
RTK1210	12 mm 130 mm	12 / 240 adet	
RTK1612	16 mm 150 mm	12 / 240 adet	



DÜZ PİM ZIMBA SETİ

- Yüksek vasıflı chrome vanadium çeliğinden üretilmiştir.
- Kendisinden daha yumuşak metalleri kesmek, şekillendirmek için kullanılır.
- Darbeye dayanıklı plastik ambalaj.

İÇERİK: 2,3,4,5,6,8 mm

KOD NO Code No	SET	PAKET/KOLİ Package/Box	FIYAT Price
RPS0208	6 pcs	10 / 40 adet	



KESKİ VE PİM ZIMBA SETİ

- Yüksek vasıflı chrome vanadium çeliğinden üretilmiştir.
- Kendisinden daha yumuşak metalleri kesmek, şekillendirmek ve kaldırmak için kullanılır.
- Tekrar bileylenebilir özellik.

İÇERİK: 4 mm nokta, 3 mm konik, 4 mm düz pim zımba 12,16 mm tesviyeci, 5 mm tırnak keski

KOD NO Code No	SET	PAKET/KOLİ Package/Box	FIYAT Price
RKZ0210	6 pcs	10 / 40 adet	

■ Bİ-METAL PANÇ TESTERELER

- Süper HSS dişler 4/6 değişken diş yapısıyla kesimi zor malzemelerde bile minimum titreşim ile pürüzsüz kesim sağlar.
- Bi metal testereler taşınır ve sabit matkaplar için uygundur.
- Özel diş yapısı sayesinde talaşlar daha verimli bir şekilde çapak atma yuvaları vasıtasıyla tahliye edilir.



KOD NO Code No	ÖLÇÜ mm	AGIRLIK Weight	PAKET/KOLİ Package/Box	FIYAT Price
RBP1014	14 mm	36 gr	100	
RBP1016	16 mm	40 gr	100	
RBP1017	17 mm	40 gr	100	
RBP1019	19 mm	44 gr	100	
RBP1020	20 mm	44 gr	100	
RBP1022	22 mm	46 gr	100	
RBP1025	25 mm	56 gr	100	
RBP1028	28 mm	67 gr	100	
RBP1029	29 mm	72 gr	100	
RBP1030	30 mm	81 gr	100	
RBP1032	32 mm	81 gr	100	
RBP1035	35 mm	85 gr	100	
RBP1038	38 mm	87 gr	100	
RBP1040	40 mm	90 gr	100	
RBP1041	41 mm	90 gr	100	
RBP1044	44 mm	100 gr	100	
RBP1048	48 mm	116 gr	100	
RBP1051	51 mm	124 gr	100	
RBP1054	54 mm	142 gr	50	
RBP1057	57 mm	157 gr	50	
RBP1065	65 mm	195 gr	50	
RBP1068	68 mm	211 gr	50	
RBP1070	70 mm	219 gr	50	
RBP1073	73 mm	234 gr	50	
RBP1076	76 mm	259 gr	50	
RBP1079	79 mm	278 gr	50	
RBP1083	83 mm	304 gr	50	
RBP1086	86 mm	317 gr	50	
RBP1089	89 mm	343 gr	50	
RBP1092	92 mm	362 gr	50	
RBP1095	95 mm	382 gr	50	
RBP1098	98 mm	397 gr	50	
RBP1102	102 mm	452 gr	20	
RBP1105	105 mm	462 gr	20	
RBP1108	108 mm	486 gr	20	
RBP1111	111 mm	502 gr	20	
RBP1114	114 mm	525 gr	20	
RBP1121	121 mm	578 gr	20	
RBP1127	127 mm	646 gr	10	
RBP1133	133 mm	701 gr	10	
RBP1140	140 mm	751 gr	10	
RBP1146	146 mm	818 gr	10	
RBP1152	152 mm	877 gr	10	





AHŞAP PANÇ ADAPTÖRÜ

KOD NO Code No	ÖLÇÜ mm	PAKET/KOLİ Package/Box	FİYAT Price
RAC0001	32-140 mm	10 / 100 adet	

2
NO



METAL PANÇ ADAPTÖRÜ

KOD NO Code No	ÖLÇÜ mm	PAKET/KOLİ Package/Box	FİYAT Price
RAB0005	32-210 mm	10 / 100 adet	

2
NO



METAL PANÇ ADAPTÖRÜ

KOD NO Code No	ÖLÇÜ mm	PAKET/KOLİ Package/Box	FİYAT Price
RAB0006	32-210 mm	10 / 100 adet	

1
NO



METAL PANÇ ADAPTÖRÜ

KOD NO Code No	ÖLÇÜ mm	PAKET/KOLİ Package/Box	FİYAT Price
RAB0003	14-32 mm	10 / 100 adet	

2
NO



SDS PANÇ ADAPTÖRÜ

KOD NO Code No	ÖLÇÜ mm	PAKET/KOLİ Package/Box	FİYAT Price
RAB0011	36 - 210 mm	10 / 100 adet	

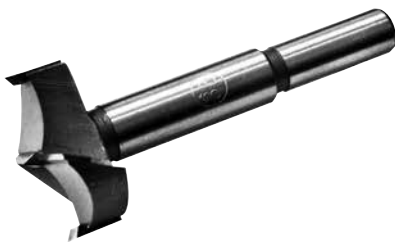

TAŞ MENTEŞE

KOD NO Code No	ÖLÇÜ mm	PAKET/KOLİ Package/Box	FİYAT Price
RFB0035	35 mm	10 / 200 adet	



ELMAS EĞE SET

KOD NO Code No	İÇERİK Details	PAKET/KOLİ Package/Box	FİYAT Price
RKE1005	5 pcs	6 / 72 adet	



AHŞAP SAPLI EĞE SET

KOD NO Code No	İÇERİK Details	PAKET/KOLİ Package/Box	FİYAT Price
RES0105	5 pcs	12 / 72 adet	





SDS PLUS MATKAP UÇLARI (4 ELMASLI)



- Merkezlemeyi artırıcı ve titreşimi azaltan 4 elmaslı geometrik yapı sayesinde daha verimli sonuç.
- Sıcak dövülmüş, sertleştirilmiş ve tavllanmış chrome vanadium.
- Özel askı kartelası ile birlikte.

KOD NO Code No	ÖLÇÜ mm	AĞIRLIK Weight	PAKET/KOLI Package/Box	FİYAT Price
RSP0516	5 x 160 mm	45 gr	20 / 400 adet	
RSP0611	6 x 110 mm	41 gr	25 / 400 adet	
RSP6521	6.5 x 210 mm	55 gr	20 / 400 adet	
RSP0711	7 x 110 mm	46 gr	25 / 400 adet	
RSP0716	7 x 160 mm	57 gr	20 / 400 adet	
RSP0721	7 x 210 mm	64 gr	20 / 200 adet	
RSP0726	7 x 260 mm	75 gr	20 / 200 adet	
RSP0816	8 x 160 mm	64 gr	20 / 400 adet	
RSP0821	8 x 210 mm	75 gr	20 / 200 adet	
RSP0826	8 x 260 mm	89 gr	20 / 200 adet	
RSP0845	8 x 450 mm	128 gr	20 / 200 adet	
RSP0916	9 x 160 mm	64 gr	20 / 400 adet	
RSP0921	9 x 210 mm	78 gr	20 / 300 adet	
RSP1011	10 x 110 mm	60 gr	25 / 400 adet	
RSP1016	10 x 160 mm	75 gr	20 / 400 adet	
RSP1021	10 x 210 mm	94 gr	20 / 200 adet	
RSP1026	10 x 260 mm	112 gr	20 / 200 adet	
RSP1035	10 x 350 mm	146 gr	20 / 100 adet	
RSP1121	11 x 210 mm	101 gr	20 / 200 adet	
RSP1216	12 x 160 mm	88 gr	20 / 200 adet	
RSP1221	12 x 210 mm	105 gr	20 / 200 adet	
RSP1226	12 x 260 mm	120 gr	10 / 200 adet	
RSP1316	13 x 160 mm	88 gr	10 / 200 adet	
RSP1416	14 x 160 mm	113 gr	10 / 200 adet	
RSP1426	14 x 260 mm	180 gr	10 / 100 adet	
RSP1435	14 x 350 mm	218 gr	10 / 100 adet	
RSP1445	14 x 450 mm	267 gr	10 / 60 adet	
RSP1460	14 x 600 mm	389 gr	10 / 60 adet	
RSP1616	16 x 160 mm	140 gr	10 / 100 adet	
RSP1645	16 x 450 mm	392 gr	10 / 60 adet	
RSP1826	18 x 260 mm	230 gr	10 / 100 adet	
RSP1835	18 x 350 mm	317 gr	10 / 60 adet	
RSP1845	18 x 450 mm	408 gr	10 / 60 adet	
RSP1860	18 x 600 mm	545 gr	10 / 60 adet	
RSP2245	22 x 450 mm	668 gr	10 / 30 adet	
RSP2435	24 x 350 mm	620 gr	10 / 30 adet	
RSP2445	24 x 450 mm	793 gr	10 / 30 adet	
RSP2645	26 x 450 mm	771 gr	10 / 30 adet	
RSP2845	28 x 450 mm	1027 gr	5 / 30 adet	



SDS MAX MATKAP UÇLARI (4 ELMASLI)

KOD NO Code No	ÖLÇÜ mm	AGIRLIK Weight	PAKET/KOLI Package/Box	FIYAT Price
RSM1226	12 x 260 mm	294 gr	10 / 60 adet	
RSM1434	14 x 340 mm	365 gr	5 / 60 adet	
RSM1634	16 x 340 mm	411 gr	10 / 60 adet	
RSM1654	16 x 540 mm	559 gr	10 / 30 adet	
RSM1854	18 x 540 mm	666 gr	10 / 30 adet	
RSM2034	20 x 340 mm	545 gr	5 / 60 adet	
RSM2052	20 x 520 mm	790 gr	10 / 30 adet	
RSM2234	22 x 340 mm	587 gr	5 / 60 adet	
RSM2252	22 x 520 mm	856 gr	10 / 30 adet	
RSM2434	24 x 340 mm	682 gr	5 / 60 adet	
RSM2452	24 x 520 mm	991 gr	10 / 30 adet	
RSM2534	25 x 340 mm	673 gr	5 / 60 adet	
RSM2837	28 x 370 mm	862 gr	5 / 60 adet	
RSM2857	28 x 570 mm	1386 gr	15 / 30 adet	
RSM3037	30 x 370 mm	935 gr	5 / 60 adet	
RSM3237	32 x 370 mm	1071 gr	15 / 60 adet	
RSM3257	32 x 570 mm	1684 gr	3 / 30 adet	



ELMAS MATKAP UÇLARI

- Sıcak dövülmüş, sertleştirilmiş ve tavllanmış chrome vanadium.

KOD NO Code No	ÖLÇÜ mm	AGIRLIK Weight	PAKET/KOLI Package/Box	FIYAT Price
REM0104	4 x 85 mm	11 gr	50 / 1000 adet	
REM0105	5 x 85 mm	14 gr	50 / 1000 adet	
REM0106	6 x 100 mm	20 gr	50 / 800 adet	
REM0107	7 x 100 mm	22 gr	40 / 800 adet	
REM0108	8 x 110 mm	33 gr	25 / 500 adet	
REM0112	12 x 120 mm	65 gr	20 / 400 adet	



ELMAS MATKAP UÇ SETİ

- Sıcak dövülmüş, sertleştirilmiş ve tavllanmış chrome vanadium.
İÇERİK: 5mm, 6mm, 7mm, 8mm, 10mm

KOD NO Code No	İÇERİK Details	PAKET/KOLI Package/Box	FIYAT Price
REM0005	5 pcs	12 / 36 adet	





SDS PLUS MURÇ (ELMASLI)

KOD NO Code No	ÖLÇÜ mm	PAKET/KOLİ Package/Box	FİYAT Price
RSM0250	250 mm	10 / 100 adet	



SDS PLUS KESKİ (ELMASLI)

KOD NO Code No	ÖLÇÜ mm	PAKET/KOLİ Package/Box	FİYAT Price
RSK0250	250 mm	10 / 100 adet	



SDS MAX MURÇ (ELMASLI)

KOD NO Code No	ÖLÇÜ mm	PAKET/KOLİ Package/Box	FİYAT Price
RSM1840	400 mm	1 / 30 adet	



SDS MAX KESKİ (ELMASLI)

KOD NO Code No	ÖLÇÜ mm	PAKET/KOLİ Package/Box	FİYAT Price
RSK1840	400 mm	1 / 30 adet	



KAROT DELME UÇLARI

KOD NO Code No	ÖLÇÜ mm	PAKET/KOLİ Package/Box	FİYAT Price
RKD0040	40 mm	1 / 50 adet	
RKD0055	55 mm	1 / 50 adet	
RKD0065	65 mm	1 / 50 adet	
RKD0080	80 mm	1 / 30 adet	



KARPIT UÇLU ELMAS TESTERE

- Kesme derinliği 60 mm
- Çelik gövde
- Seramik, fiberglas ve kompozitleri kesmek için
- Ekstra sertleştirilmiş dişler

KOD NO Code No	ÖLÇÜ mm	PAKET/KOLİ Package/Box	FİYAT Price
REP0033	240 mm	10 / 50 adet	



ANAHTARLI MANDRENLER

KOD NO Code No	ÖLÇÜ mm	AĞIRLIK Weight	PAKET/KOLI Package/Box	FIYAT Price
RAM1038	3/8 - 24 UNF x 10 mm	215 gr	1 / 100 adet	
RAM1312	1/2 - 20 UNF x 13 mm	320 gr	1 / 50 adet	
RAM1338	3/8 - 24 UNF x 13 mm	336 gr	1 / 50 adet	
RAM1618	B18 x 16 mm	631 gr	1 / 25 adet	



ANAHTARLI MANDREN

KOD NO Code No	ÖLÇÜ mm	AĞIRLIK Weight	PAKET/KOLI Package/Box	FIYAT Price
REM1338	13 mm	336 gr	1 / 50 adet	



PLASTIK-METAL MANDREN

KOD NO Code No	ÖLÇÜ mm	AĞIRLIK Weight	PAKET/KOLI Package/Box	FIYAT Price
RPM1312	13 mm	298 gr	1 / 50 adet	





METAL SUPRA MANDRENLER

KOD NO Code No	ÖLÇÜ mm	PAKET/KOLİ Package/Box	FİYAT Price
RMS1616	16 mm	1 / 25 adet	
RMS1618	16 mm	1 / 25 adet	

GARANTİ
KAPSAM DIŞI



KÖŞELİ BITS MANDRENİ

- Şarjlı vidalamalar ile kullanım için.

KOD NO Code No	ÖLÇÜ mm	PAKET/KOLİ Package/Box	FİYAT Price
RMB1210	1/4"	24 / 144 adet	

GARANTİ
KAPSAM DIŞI



MİNİ METAL MANDREN

- Şarjlı vidalamalar ile kullanım için.

KOD NO Code No	ÖLÇÜ mm	PAKET/KOLİ Package/Box	FİYAT Price
RMA0405	1/4"	24 / 144 adet	



MANDREN ANAHTARI

KOD NO Code No	ÖLÇÜ mm	PAKET/KOLİ Package/Box	FİYAT Price
RMA0013	13 mm	1 / 250 adet	

TESİSATÇI ALETLER

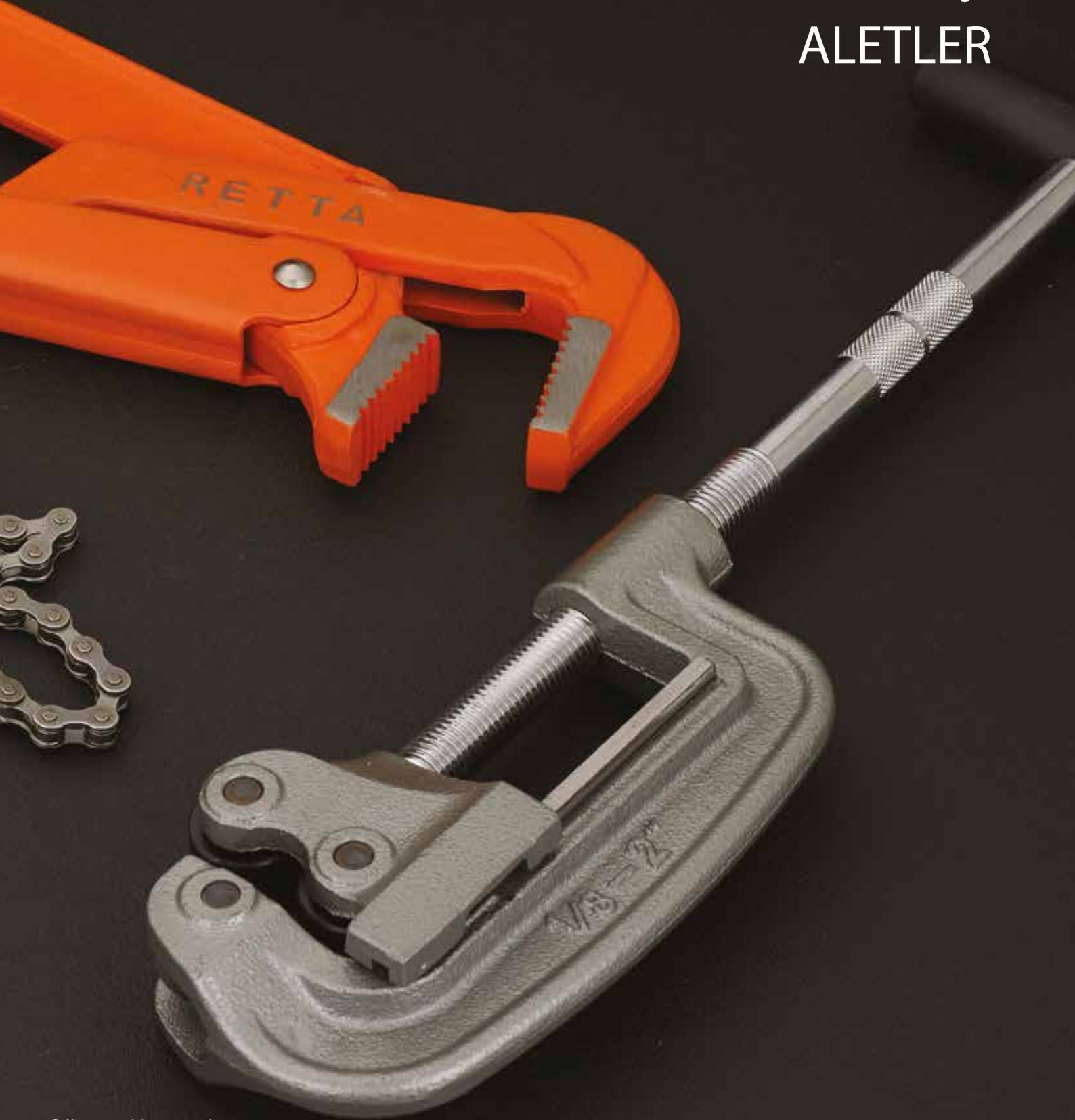

Güç ve Hassasiyet

- ◆ Bükülmeye ve kırılmaya karşı yüksek dayanıklılığa sahip Chrome Vanadium çeliğinden üretilmiştir.
- ◆ Hobi kullanımdan, zorlu koşullar altında, sanayinin aradığı en üst kalite değerlerine uygundur.

Ergonomi ve Geniş Ürün Gami

- ◆ Yüksek kaliteli saplar kaymaya karşı koruyuculuğu olup ergonomiktir ve yorulmadan çalışmayı sağlar.
- ◆ Keskin kenarları sıkıntısız O'a indirilmiş ergonomik gövde tasarımı.
- ◆ Güçlü tutuş ve kavrama özelliğine sahip, geniş ürün gamı



MANŞONLU BORU ANAHTARI 90°

- Yüksek vasıflı chrome vanadium çeliğinden üretilmiştir.
- Ağız kısmı ayrıca İndüksiyonla sertleştirilmiştir.
- Döndürme yönünün tersi konumdaki dişler kendiliğinden sıkımayı sağlar.

KOD NO Code No	ÖLÇÜ mm	PAKET/KOLİ Package/Box	FİYAT Price
RMB0110	1"	1 / 36 adet	
RMB0115	1.5"	1 / 24 adet	
RMB0120	2"	1 / 12 adet	
RMB0130	3"	1 / 6 adet	



ZİNCİRLİ FİLTRE ANAHTARI

Made in
Turkey

- Her iki yönde emniyetli kavrayarak çalışma imkanı sağlar.
- Parlak krom kaplama yüzey.

KOD NO Code No	ÖLÇÜ mm	PAKET/KOLİ Package/Box	FİYAT Price
RZB0009	225 mm	6 / 36 adet	



ZİNCİRLİ BORU ANAHTARI

Made in
Turkey

- Her iki yönde emniyetli kavrayarak çalışma imkanı sağlar.
- Parlak krom kaplama yüzey.

KOD NO Code No	ÖLÇÜ mm	PAKET/KOLİ Package/Box	FİYAT Price
RZB0012	300 mm	6 / 36 adet	



HAVŞA AÇMA SETİ

- Havşa ağızında çatlak oluşturmaz.
- Bakır, hafif alaşımli metal, pirinç ve yumuşak çelik borulara havşa açmak için.

KOD NO Code No	İÇERİK Details	PAKET/KOLİ Package/Box	FİYAT Price
RHS0418	2 pcs	6 / 100 adet	



PROFESYONEL PVC BORU MAKASI

- Her iki yönde emniyetli kavrayarak çalışma imkanı sağlar.
- Parlak krom kaplama yüzey.

KOD NO Code No	ÖLÇÜ mm	PAKET/KOLİ Package/Box	FİYAT Price
RBM0042	Ø 42 mm	6 / 36 adet	



MINİ BAKIR BORU KESME

- Küçük çalışma açısı ile güç erişilen yerlerde çalışma olanağı.
- Bakır, pirinç, alüminyum ve ince duvarlı çelik boruların kesiminde kullanılır.

KOD NO Code No	ÖLÇÜ mm	PAKET/KOLİ Package/Box	FIYAT Price
RBB0322	3-22 mm	10 / 100 adet	



TELESKOPİK BAKIR BORU KESME

- Küçük çalışma açısı ile güç erişilen yerlerde çalışma olanağı.
- Bakır, pirinç, alüminyum ve ince duvarlı çelik boruların kesiminde kullanılır.
- Saklanabilen iç çapak alma çakısı ve yedek bıçağı.
- Teleskopik bıçak sürgüsü sayesinde hızlı ayarlama imkanı.

KOD NO Code No	ÖLÇÜ mm	PAKET/KOLİ Package/Box	FIYAT Price
RBB0638	6 - 38 mm	6 / 48 adet	
RBB0638B	YEDEK	6 / 48 adet	



BAKIR BORU KESME

- Flanşlı boruları kesmek için kullanılır
- Hafif zink gövdeden mamül.
- Bakır, pirinç, alüminyum ve ince duvarlı çelik boruların kesiminde kullanılır.

KOD NO Code No	ÖLÇÜ mm	PAKET/KOLİ Package/Box	FIYAT Price
RBB0330	3 - 30 mm	10 / 60 adet	
RBB0330B	YEDEK	10 / 60 adet	



ÇELİK BORU KESME

- Enli makaralar bıçağın iç tutumunu kolaylaştırır.
- Döküm çeliğinden mamül gövde, güçlü ve dayanıklı uzun süre kesimler için.
- Büyük kavrama kolu sayesinde kolayca ayarlanabilir kesme basıncı.

KOD NO Code No	ÖLÇÜ mm	PAKET/KOLİ Package/Box	FIYAT Price
RBB1250	12 - 50 mm	1 / 8 adet	
RBB1250B	YEDEK	1 / 8 adet	



Güç ve Hassasiyet

- ◆ Hassas kesim toleranslarına sahip Chrome Vanadium çeliğinden üretilmiştir.
- ◆ Hobi kullanımdan, zorlu koşullar altında, sanayinin aradığı en üst kalite değerlerine uygundur.
- ◆ Kesici ağızlar özel olarak sertleştirilmiş ve ileri teknoloji ile bilenmiştir.

Ergonomi ve Geniş Ürün Gami

- ◆ İki bileşenli yüksek kaliteli saplar kaymaya karşı koruyuculuğu olup ergonomiktir ve yorulmadan çalışmayı sağlar.
- ◆ Keskin kenarları sıkıntısız 0'a indirilmiş ergonomik gövde tasarımı.

KESİCİ ALETLER





1.2mm'e kadar kesme kapasitesi



KAPORTACI MAKASI MAFSALLI

- Çift malzemeli yumuşak ve ergonomik sap.
- İndüksiyonla sertleştirilmiş hassas kesici ağızlar.
- Sıcak dövülmüş hassas sertleştirilmiş özel çelik kullanılarak üretilmiştir.

KOD NO Code No	ÖLÇÜ mm	PAKET/KOLI Package/Box	FIYAT Price
RKM250S	250 mm Düz	6 / 36 adet	
RKM250L	250 mm Sol	6 / 36 adet	
RKM250R	250 mm Sağ	6 / 36 adet	



1.2mm'e kadar kesme kapasitesi



KAPORTACI MAKASI MAFSALLI

- Çift malzemeli yumuşak ve ergonomik sap.
- İndüksiyonla sertleştirilmiş hassas kesici ağızlar.
- Sıcak dövülmüş hassas sertleştirilmiş özel çelik kullanılarak üretilmiştir.
- Paslanmaz veya rulo çelikte kısa, düz ve eğri kesimler yapmak için.

KOD NO Code No	ÖLÇÜ mm	PAKET/KOLI Package/Box	FIYAT Price
RKS0300	300 mm	6 / 36 adet	



1.0mm saç kesme



KAPORTACI MAKASI YAYLI

- PVC kaplama saplar.
- İndüksiyonla sertleştirilmiş hassas kesici ağızlar.
- Sıcak dövülmüş hassas sertleştirilmiş özel çelik kullanılarak üretilmiştir.

KOD NO Code No	ÖLÇÜ mm	PAKET/KOLI Package/Box	FIYAT Price
RKM0250	250 mm (Sağ)	6 / 36 adet	
RKM0255	255 mm (Sol)	6 / 36 adet	



TENEKECİ MAKASI YAYLI

- PVC kaplama saplar.
- İndüksiyonla sertleştirilmiş hassas kesici ağızlar.
- Sıcak dövülmüş hassas sertleştirilmiş özel çelik kullanılarak üretilmiştir.

KOD NO Code No	ÖLÇÜ mm	PAKET/KOLI Package/Box	FIYAT Price
RTM0250	250 mm	6 / 36 adet	



KUYUMCU MAKASI DÜZ - CONTA MAKASI

- İndüksiyonla sertleştirilmiş hassas kesici ağızlar.
- Teneke, sac, hafif metal ve kauçuk kesmek; hassas el işçiliği gereken yerde kullanılır.
- Sıcak dövülmüş hassas sertleştirilmiş özel çelik kullanılarak üretilmiştir.

KOD NO Code No	ÖLÇÜ mm	PAKET/KOLİ Package/Box	FIYAT Price
RKD0175	180 mm	10 / 100 adet	



KUYUMCU MAKASI EĞRİ - CONTA MAKASI

- İndüksiyonla sertleştirilmiş hassas kesici ağızlar.
- Teneke, sac, hafif metal ve kauçuk kesmek; hassas el işçiliği gereken yerde kullanılır.
- Sıcak dövülmüş hassas sertleştirilmiş özel çelik kullanılarak üretilmiştir.

KOD NO Code No	ÖLÇÜ mm	PAKET/KOLİ Package/Box	FIYAT Price
RKE0180	180 mm	10 / 100 adet	



ÇOK AMAÇLI MAKAS OLUKLU - ELEKTRİKÇİ MAKASI

- İndüksiyonla sertleştirilmiş hassas kesici ağızlar.
- Elektrik panoları, sigorta panoları gibi hassas kesimler için kullanılır.
- Sıcak dövülmüş hassas sertleştirilmiş özel çelik kullanılarak üretilmiştir.

KOD NO Code No	ÖLÇÜ mm	PAKET/KOLİ Package/Box	FIYAT Price
RGM1150	150 mm	12 / 144 adet	



ÇOK AMAÇLI MAKAS - ELEKTRİKÇİ MAKASI

- İndüksiyonla sertleştirilmiş hassas kesici ağızlar.
- Elektrik panoları, sigorta panoları gibi hassas kesimler için kullanılır.
- Sıcak dövülmüş hassas sertleştirilmiş özel çelik kullanılarak üretilmiştir.

KOD NO Code No	ÖLÇÜ mm	PAKET/KOLİ Package/Box	FIYAT Price
RGM0150	150 mm	12 / 144 adet	



SOKETLİ ELMAS TESTERELER

- Soğuk, katılaştırılmış elmas uçlar.
- Soket dizaynı ile daha kolay kesme ve daha az çapak bırakma.
- Vakum ambalaj.
- Elmas yüksekliği: 7.0mm
- Granit, beton, mermer, fayans ve diğer materyallerde kullanmak için.

KOD NO Code No	ÖLÇÜ mm	PAKET/KOLİ Package/Box	FİYAT Price
RGS0115	115 SG 22.23 mm	1 / 100 adet	
RGS0180	180 SG 22.23 mm	1 / 50 adet	
RGS0230	230 SG 22.23 mm	1 / 25 adet	



SÜPER TURBO ELMAS TESTERELER

- Soğuk, katılaştırılmış elmas uçlar.
- Soket dizaynı ile daha kolay kesme ve daha az çapak bırakma.
- Vakum ambalaj.
- Elmas yüksekliği: 7.0mm
- Granit, beton, mermer, fayans ve diğer materyallerde kullanmak için.

KOD NO Code No	ÖLÇÜ mm	PAKET/KOLİ Package/Box	FİYAT Price
RGF0180	180 FL 22.23 mm	1 / 50 adet	



TURBO KANALLI ELMAS TESTERELER

- Soğuk, katılaştırılmış elmas uçlar.
- Soket dizaynı ile daha kolay kesme ve daha az çapak bırakma.
- Vakum ambalaj.
- Elmas yüksekliği: 7.0mm
- Granit, beton, mermer, fayans ve diğer materyallerde kullanmak için.

KOD NO Code No	ÖLÇÜ mm	PAKET/KOLİ Package/Box	FİYAT Price
RGT0180	180 TW 22.23 mm	1 / 50 adet	
RGT0230	230 TW 22.23 mm	1 / 25 adet	

TURBO SOKETLİ ELMAS TESTERELER

- Soğuk, katılaştırılmış elmas uçlar.
- Soket dizaynı ile daha kolay kesme ve daha az çapak bırakma.
- Vakum ambalaj.
- Elmas yüksekliği: 7.0mm
- Granit, beton, mermer, fayans ve diğer materyallerde kullanmak için.

KOD NO Code No	ÖLÇÜ mm	PAKET/KOLİ Package/Box	FİYAT Price
RGT2180	180 T 22.23 mm	1 / 100 adet	
RGT2230	230 T 22.23 mm	1 / 50 adet	



SUNTA ELMAS TESTERELER

- Elmas uçlu kesme ağızlar, parlak cilalı.
- Islak ve kuru ahşap kesimi için dizayn edilmiştir.
- Vakum ambalaj.

KOD NO Code No	ÖLÇÜ mm	PAKET/KOLİ Package/Box	FİYAT Price
RDT1516	150x16 30 mm	1 / 50 adet	
RDT1824	180x24 30 mm	1 / 50 adet	
RDT1840	180x40 30 mm	1 / 50 adet	
RDT1924	190x24 30 mm	1 / 50 adet	
RDT1940	190x40 30 mm	1 / 50 adet	
RDT2132	210x32 30 mm	1 / 50 adet	



DEKOPAJ BIÇAK SETİ

- Ağaç, plastik ve diğer yumuşak materyal kesimleri için.
- İndüksiyonla sertleştirilmiş hassas ve kesici bıçak.
- Çapaksız kesim bıçağı.

KOD NO Code No	İÇERİK Details	PAKET/KOLİ Package/Box	FİYAT Price
RDB5101	5 pcs	10 / 400 adet	





YEDEK BIÇAĞI YEDEĞİ - 10'LU PAKET

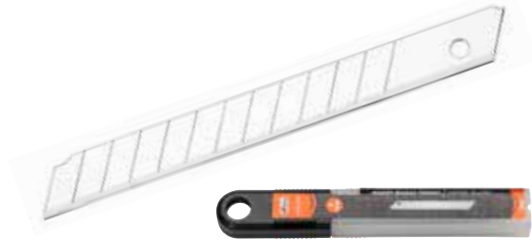

- SK-2 Çeliğinden imal
- Kullanım ömrünü uzatıcı dar kırımlı yapı



KOD NO Code No	ÖLÇÜ mm	PAKET/KOLİ Package/Box	FIYAT Price
RMB0900	9 mm	10 / 300 adet	

YEDEK BIÇAĞI YEDEĞİ - 10'LU PAKET



- SK-2 Çeliğinden imal
- Kullanım ömrünü uzatıcı dar kırımlı yapı



KOD NO Code No	ÖLÇÜ mm	PAKET/KOLİ Package/Box	FIYAT Price
RMB1800	18 mm	10 / 200 adet	

MAKET BIÇAĞI



KOD NO Code No	ÖLÇÜ mm	PAKET/KOLİ Package/Box	FIYAT Price
RMB0014	18 mm	12 / 144 adet	

MEKANİK ZIMBA TABANCASI



10F Serisi teller ile kullanım

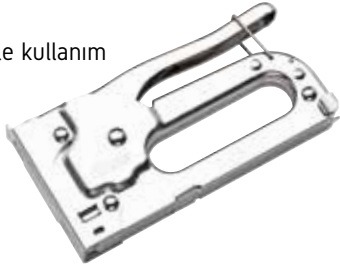

- Endüstriyel ve hobi kullanım amaçlı.
- Metal gövde yapı.
- Tel Genişliği: 0.7 mm / Uzunluk: 4, 6, 8 mm / Çene Genişliği: 11.3 mm

KOD NO Code No	MODEL Model	AĞIRLIK Weight	PAKET/KOLİ Package/Box	FIYAT Price
RMZ0176		435 gr	20 / 40 adet	

MEKANİK ZIMBA TABANCASI



8F - 10F Serisi teller ile kullanım



- Endüstriyel ve hobi kullanım amaçlı.
- Metal gövde yapı.
- Tel Genişliği: 0.7 mm / Uzunluk: 6, 8, 10 mm / Çene Genişliği: 12.7 mm

KOD NO Code No	MODEL Model	AĞIRLIK Weight	PAKET/KOLİ Package/Box	FIYAT Price
RMZ0610		519 gr	6 / 24 adet	

MEKANİK ZIMBA TABANCASI



8F Serisi teller ile kullanım



- Endüstriyel ve hobi kullanım amaçlı.
- Metal gövde yapı.
- Tel Genişliği: 0.5, 0.7 mm / Uzunluk: 6, 8 mm / Çene Genişliği: 12.7 mm

KOD NO Code No	MODEL Model	AĞIRLIK Weight	PAKET/KOLİ Package/Box	FIYAT Price
RMZ0133		417 gr	10 / 40 adet	



RHZ9041-1832-1850 tabanca ile kullanım



F BAŞLI ŞERİT ÇİVİ

KOD NO Code No	ÖLÇÜ mm	PAKET/KOLİ Package/Box	FIYAT Price
RCF0015	15 mm	5000 adet / 20 paket	
RCF0020	20 mm	5000 adet / 20 paket	
RCF0025	25 mm	5000 adet / 20 paket	
RCF0035	35 mm	5000 adet / 20 paket	
RCF0040	40 mm	5000 adet / 20 paket	
RCF0050	50 mm	5000 adet / 20 paket	



RHC1650 tabanca ile kullanım



T BAŞLI ŞERİT ÇİVİ

KOD NO Code No	ÖLÇÜ mm	PAKET/KOLİ Package/Box	FIYAT Price
RCT0020	20 mm	2500 adet / 12 paket	
RCT0025	25 mm	2500 adet / 12 paket	
RCT0030	30 mm	2500 adet / 12 paket	
RCT0032	32 mm	2500 adet / 12 paket	
RCT0040	40 mm	2500 adet / 12 paket	
RCT0050	50 mm	2500 adet / 12 paket	



RHZ9040-9041 tabanca ile kullanım



90 SERİSİ ZIMBA TELİ

KOD NO Code No	ÖLÇÜ mm	PAKET/KOLİ Package/Box	FIYAT Price
RCZ9008	8 mm	2500 adet / 20 paket	
RCZ9013	13 mm	2500 adet / 20 paket	
RCZ9016	16 mm	2500 adet / 20 paket	
RCZ9022	22 mm	2500 adet / 20 paket	
RCZ9028	28 mm	2500 adet / 20 paket	
RCZ9035	35 mm	2500 adet / 20 paket	



8F SERİSİ ZIMBA TELİ

KOD NO Code No	ÖLÇÜ mm	PAKET/KOLİ Package/Box	FIYAT Price
RZT8008	8 mm	5000 adet / 20 paket	
RZT8010	10 mm	5000 adet / 20 paket	
RZT8014	14 mm	5000 adet / 20 paket	



11.3 mm



10F SERİSİ ZIMBA TELİ

KOD NO Code No	ÖLÇÜ mm	PAKET/KOLİ Package/Box	FIYAT Price
RZT1006	6 mm	5000 adet / 40 paket	
RZT1008	8 mm	5000 adet / 40 paket	



RHZ0851 tabanca ile kullanım



10.8 mm



N SERİSİ ZIMBA TELİ

KOD NO Code No	ÖLÇÜ mm	PAKET/KOLİ Package/Box	FIYAT Price
RCN0038	38 mm	1000 adet / 10 paket	



RHC0622 tabanca ile kullanım



18mm

64mm

BAŞSIZ ÇİVİ

KOD NO Code No	ÖLÇÜ mm	PAKET/KOLİ Package/Box	FIYAT Price
RBC0622	22 mm	1000 adet / 48 paket	

ÖLÇÜ ALETLERİ





DİJİTAL MULTİMETRE

- Dijital aydınlatmalı ekran.
- LCD ekran, 1000 volt (A71) yalıtımlı.
- Voltaj (AC/DC) akım, direnç, kapasitans, frekans, diyot ve sıcaklık ölçümü.



DC Voltage	400mV~ 4V~ 40V~ 400V~ 600V
DC Current	400µA~ 4000µA~ 40mA ~400mA ~4A ~10A
AC Voltage	4V~ 40V~ 400V~ 600V
AC Current	400µA~ 4000µA~ 40mA ~400mA ~4A ~10A
Resistance	400Ω~4kΩ~40kΩ~400kΩ~4MΩ~40MΩ
Frequency	10Hz~100Hz~1Hz~10kHz~100kHz
Capacitance	40nF~400nF~4µF~40µF~100µF

KOD NO Code No	AĞIRLIK Weight	PAKET/KOLİ Package/Box	FİYAT Price
RMM6000	713 gr	1 / 24 adet	

DİJİTAL MULTİMETRE

- Dijital ekran.
- LCD ekran, 1000 volt (A71) yalıtımlı.
- Voltaj (AC/DC) akım, direnç, kapasitans, diyot ve sıcaklık ölçümü.



DC Voltage	400mV~ 4V~ 40V~ 400V~ 600V
DC Current	400µA~ 4000µA~ 40mA ~400mA ~4A ~10A
AC Voltage	4V~ 40V~ 400V~ 600V
AC Current	400µA~ 4000µA~ 40mA ~400mA ~4A ~10A
Resistance	400Ω~4kΩ~40kΩ~400kΩ~4MΩ~40MΩ~
Frequency	9.999Hz~99.99Hz~999.9Hz~9.999kHz~99.99kHz~200kHz ~>200kHz
Capacitance	40nF~400nF~4µF~40µF~100µF

KOD NO Code No	AĞIRLIK Weight	PAKET/KOLİ Package/Box	FİYAT Price
RMM5000	684 gr	1 / 24 adet	

MINİ MULTİMETRE

- Analog gösterge paneli.
- AC/DC ölçüm özelliği.



DC Voltage	0V~ 10V~ 50V~ 250V~ 500V Accuracy at FSD: 5; 2000Ω/V
DC Current	0~ 25~ 250mA Accuracy at FSD: 5;
AC Voltage	0V~ 50V~ 250V~ 500V Accuracy at FSD: 5; 2000Ω/V
Resistance	0~ 10kΩ~ 1MΩ Accuracy at FSD: 5;(arc length) central value 5.5
Decibel	+4 ~ +36dB
Battery Test	1.5 V (about 100 mA) 9V (about 20 mA)
Safety Standard	IEC-61010-1, CAT II 500V

KOD NO Code No	AĞIRLIK Weight	PAKET/KOLİ Package/Box	FİYAT Price
RMM0066	221 gr	1 / 24 adet	

DİJİTAL PENS AMPERMETRE

- LCD ekran, 1000 volt (A71) yalıtımlı.
- Voltaj (AC/DC) akım, direnç, kapasitans, frekans, diyot ve sıcaklık ölçümü.



DC Voltage	200mV~2V~ 20V~ 200V~ 600V
AC Voltage	2V~ 20V~ 200V~ 600V
AC Current	2A~ 20A ~200A ~600A
Resistance	200mΩ~2kΩ~20kΩ~200kΩ~2MΩ~20MΩ

KOD NO Code No	AĞIRLIK Weight	PAKET/KOLİ Package/Box	FİYAT Price
RPA3000	550 gr	1 / 24 adet	

IP65 Toz Dayanım

CAT IV 1000V Kullanıcıyı Koruma Özelliği

IS16519 Yüksek Emniyet



ÇİFT KUTUPLU VOLTAJ KALEMİ

DC Voltage	6 - 1000
AC Voltage	24 - 1000
V Bar Gösterge	6 / 12 / 24 / 50 / 120 / 230 / 400 / 690 / 1000
Hassasiyet	+-%3 + 3V

KOD NO Code No	AĞIRLIK Weight	PAKET/KOLİ Package/Box	FİYAT Price
RMK0734	320 gr	1 / 24 adet	

MEKANİK KUMPAS

- İçeriden, dışarıdan ve derinlik ölçümü yapabilen çeneler.
- Özel verniyerli skala sayesinde kolay okunabilme
- Ölçü ve tartı aletleri kontrol dairesinden alınmış uygunluk belgeli.

KOD NO Code No	ÖLÇÜ mm	PAKET/KOLİ Package/Box	FIYAT Price
RMK0150	152x230 mm	1 / 40 adet	



DİJİTAL KUMPAS

- Ölçümler mm'den inch'e çevrilebilir.
- Derinlik ölçümü.
- Dayanıklı sert kutu plastik içerisinde.
- Ölçü ve tartı aletleri kontrol dairesinden alınmış uygunluk belgeli.

KOD NO Code No	ÖLÇÜ mm	PAKET/KOLİ Package/Box	FIYAT Price
RDK0150	152x235 mm	1 / 40 adet	



MİKRO METRE

- 0.01 mm hassasiyet.
- Dayanıklı dış gövde.
- Ölçme kuvvet uygulaması circırlıdır.
- Saten krom skala.

KOD NO Code No	ÖLÇÜ mm	PAKET/KOLİ Package/Box	FIYAT Price
RMM0025	0-25 mm	1 / 30 adet	
RMM2550	25-50 mm	1 / 30 adet	





ŞERİT METRE

- Metrik bölümlü ölçü aletleri.
- Sabitleme klipsli ve geri sarım durdurma düzenekli metreler.
- Ölçü ve tartı aletleri kontrol dairesinden alınmış uygunluk belgesi.

KOD NO Code No	ÖLÇÜ mm	PAKET/KOLİ Package/Box	FİYAT Price
RCM0316	3 Mx 16 mm	1 / 40 adet	
RCM0525	5 Mx 25 mm	1 / 40 adet	



ÇELİK GÖNYE

- Alüminyum gövde ve paslanmaz çelik cetvel.
- Kolay okunabilen numaralandırma sistemi.

KOD NO Code No	ÖLÇÜ mm	PAKET/KOLİ Package/Box	FİYAT Price
RCG1025	250 mm	1 / 80 adet	
RCG1030	300 mm	1 / 80 adet	
RCG1035	350 mm	1 / 60 adet	
RCG1040	400 mm	1 / 60 adet	
RCG1050	500 mm	1 / 60 adet	



ÇELİK CETVEL

- Paslanmaz çelik cetvel.
- Kolay okunabilen numaralandırma sistemi.

KOD NO Code No	ÖLÇÜ mm	PAKET/KOLİ Package/Box	FİYAT Price
RCC0300	25 - 300 mm	12 / 300 adet	
RCC0500	30 - 500 mm	20 / 200 adet	
RCC0600	30 - 600 mm	20 / 200 adet	
RCC1000	35 - 1000 mm	20 / 60 adet	
RCC1500	40 - 1500 mm	20 / 60adet	

OTO BAKIM ALETLERİ





13
PCS

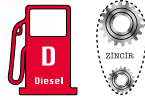

SENTE APARAT TAKIMI - BMW

- BMW, LANDROVER, ROVER, OPEL grubu dizel araçlarda ekzantrik mili zamanlama kiti.
- BMW: 1, 2, 3, 5, 6, 7, X3, X5 serisi / LANDROVER: Freelander, Range
- ROVER: 75, MG, MG ZT / OPEL: Omega -B
- Motor Kodları: M41, M51, M47, M47R, M47TU/T2, M57TU/T2, Y25DT
(Daha detaylı model ve motor kodları için kullanım kılavuzuna bakınız.)

KOD NO Code No	İÇERİK Details	PAKET/KOLİ Package/Box	FİYAT Price
RSA0090	13 pcs	1 / 10 adet	

18
PCS

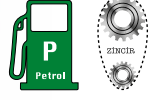

SENTE APARAT TAKIMI - BMW

- BMW grubu benzinli araçlarda ekzantrik milinin takılması ve sökülmesi için kullanılır.
- 118i E81/82/87/88 (04-12) / 120i E81/82/87/88 (04-12) / 316/ti Compact E46 (01-07) / 318/ti Compact E46 (01-07) / 318i E90/91/92/93 (05-12) / 320i E90/91/92/93 (05-12) / 520i E60/61 (07-10) / Z4 2.0 E85/86 (04-09) / X1 sDrive 18i E84 (10-12) / X1 xDrive 18i E84 (10-12) / X3 2.0 E83 (05-10)
- Motor Kodları: N42/N46/N46T:B18, B18A, B20, B20A, B20B, B20BD, B20BZ, B202
(Daha detaylı model ve motor kodları için kullanım kılavuzuna bakınız.)

KOD NO Code No	İÇERİK Details	PAKET/KOLİ Package/Box	FİYAT Price
RSA0091	18 pcs	1 / 10 adet	

8
PCS



SENTE APARAT TAKIMI - BMW

- BMW grubu benzinli araçlarda triger kayışı-zinciri değişimi için sente aparat takımı.
- 118i E81/82/87/88 (04-12) / 120i E81/82/87/88 (04-12) / 316ti Compact E46 (01-07)
- 318i/ti Compact E46 (01-07) / 318i E90/91/92/93 (05-12) / 320i E90/91/92/93 (05-12)
- 520i E60/61 (07-10) / Z4 2.0 E85/E86 (04-09) / X1 sDrive 18i E84 (10-12) / X1 xDrive 18i E84 (10-12) X3 2.0 E83 (05-10)
Motor Kodları: N42/N46/N46T:B18, B18A, B20, B20A, B20B, B20BD, B20BZ, B202 (Daha detaylı model ve motor kodları için kullanım kılavuzuna bakınız.)

KOD NO Code No	İÇERİK Details	PAKET/KOLİ Package/Box	FİYAT Price
RSA0089	8 pcs	1 / 10 adet	

5
PCS

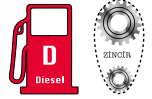

SENTE APARAT TAKIMI - BMW

- BMW grubu dizel araçlarda ekzantrik milinin takılması ve sökülmesi için kullanılır.
- 116d E81/82/87/88(08-12) / 118d E81/82/87/88 (07-14) / 120d E81/82/87/88(07-14)
- 123d E81/8287/88(07-14) / 316d E90/91/92/93(09-12) / 318d E90/91/92/93(07-12)
- 320d E90/91/92/93(07-12) / 325d E90/91/92/93(10-14) / 330d/xd E90/91/92/92(08-14) / 520d E60/61(07-10) / 525d F10/11(10-12) / 530d F10/11(10-13) / 530dGT F07(09-12) / 535d F10/11 (10-12) / 535dGT F07(10-12) / 730d/Ld F01/02/04(08-12) / 740d F01/02/04(09-12) / 740dxDrive F01/02/04(09-12) / X1sDrive 18d E84(09-12) / X1 sDrive 20d E84(09-12) / X1xDrive 18d E84(09-14) / X1xDrive 20d E84(09-12)
- X1xDrive 23d E84(09-12) / X3 2.0d E83(07-10) / X3xDrive 30d E71/72(10-14) / X6xDrive 40d E71/72(10-14) / Clubman (10-14) / Clubvan (12-14) / Countryman(10-14) / Mini(10-14)Paceman(13-14) / Roadster (12-14) Motor Kodları: N47/ N47S: C16K1, C16U1, C20K1, C20U1, D20A, D20B, D2000, D20T0, D20U0 N57: D3000,D3001,D30T0,D30U0
(Daha detaylı model ve motor kodları için kullanım kılavuzuna bakınız.)

KOD NO Code No	İÇERİK Details	PAKET/KOLİ Package/Box	FİYAT Price
RSA0053	5 pcs	1 / 10 adet	

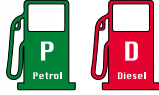
 32
PCS

SENTE APARAT TAKIMI - VW/AUDI

- Volkswagen, Audi, Skoda, Seat grubu benzinli ve dizel araçlarda triger kayışı-zinciri değişimi için sente aparat takımı.
- 1.2 6V/12V, 1.4, 1.6, 1.8, 1.8T, 2.0 16V benzinli motorlar
- 1.4, 1.9, 2.0 TDi dizel motorlar
(Daha detaylı model ve motor kodları için kullanım kılavuzuna bakınız.)

KOD NO Code No	İÇERİK Details	PAKET/KOLİ Package/Box	FİYAT Price
RSA0010	32 pcs	1 / 10 adet	

 4
PCS

SENTE APARAT TAKIMI - VW/AUDI

- Volkswagen, Audi, Skoda, Seat grubu benzinli ve dizel araçlarda triger kayışı-zinciri değişimi için sente aparat takımı.
- Volkswagen: Eos, Fox, Polo / Seat: Ibiza, Cordoba / Skoda: Fabia,
- Fabia II, Roomster
Motor Kodları: 6V – AWY, BBM, BMD, CHFA, CHFB 12V – AZQ, BME, BXV, BZG, CEVA, CGPA, CGPB, CJLA (Daha detaylı model ve motor kodları için kullanım kılavuzuna bakınız.)

KOD NO Code No	İÇERİK Details	PAKET/KOLİ Package/Box	FİYAT Price
RSA0012	4 pcs	1 / 10 adet	

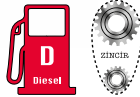
 6
PCS

SENTE APARAT TAKIMI - VW/AUDI

- Volkswagen, Audi, Skoda grubu dizel araçlarda triger kayışı-zinciri değişimi için sente aparat takımı.
- VAG 1.2D, 1.4D, 1.6D, 1.9D, 2.0D TDI PD/CR motorlarda kullanılır.
- Audi A4, A6
- Skoda
- VW Golf, Golf Plus, Jetta Ve Touran
(Daha detaylı model ve motor kodları için kullanım kılavuzuna bakınız.)

KOD NO Code No	İÇERİK Details	PAKET/KOLİ Package/Box	FİYAT Price
RSA0078	6 pcs	1 / 10 adet	



SENTE APARATI

- Volkswagen grubu araçlarda ekzantrik kaskağının kilitletmesinde kullanılır.
- Volkswagen: Lupo 99, Polo 95, Caddy 96, Polo Classic, Variant 96,
- Beetle 1.4 lt 99,
- Golf 1.4 1.6 98, Bora 1.4 1.6 99
- (Daha detaylı model ve motor kodları için kullanım kılavuzuna bakınız.)

KOD NO Code No	İÇERİK Details	PAKET/KOLİ Package/Box	FİYAT Price
RSA0079	1 pcs	1 / 10 adet	



22
PCS

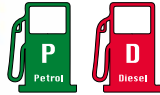

SENTE APARAT TAKIMI - RENAULT

- RENAULT grubu benzinli ve dizel araçlarda triger kayışı/zinciri değişimi için komple aparat takımı
Clio 1.2/1.4 / Clio 1.4/1.6/1.8 16v / Clio Sport 2.0 16v / Clio Williams 2.0 16v / Espace 2.0 Espace 2.0 16v / Espace 2.2 TD / Express 1.4 / Extra 1.4 / Kangoo 1.2/1.4 / Laguna 1.6 16v Laguna 1.8/2.0 / Laguna 1.8/2.0 16v / Laguna 2.2 D/TD / Laguna 2.5 D/TD
Megane 1.4/1.6/2.0/ 16v / Megane 2.5D/TD / R19 1.4 / R19 1.4 Eco / R19 1.8 16v
Rapid 1.4 / Safrane 2.0 16v, Safrane 2.2 TD / Safrane 2.5 20v / Scenic 1.4/1.6/2.0 16v
Trafic 2.5D / Twingo 1.2 / Master 2.5D/TD
Motor Kodları: F4P | F4R | F4J | K4M (Clio 3 813 Engine (03-))
(Daha detaylı model ve motor kodları için kullanım kılavuzuna bakınız.)

KOD NO Code No	İÇERİK Details	PAKET/KOLİ Package/Box	FİYAT Price
RSA0080	22 pcs	1 / 10 adet	

36
PCS



SENTE APARAT TAKIMI - PEUGEOT

- PEUGEOT, CITROEN grubu benzinli ve dizel araçlarda triger kayışı/zinciri değişimi için komple aparat takımı
1.0, 1.1., 1.4, 1.6, 1.6 VTS, 1.8 16V, 1.9, 2.0, 2.2 16V benzinli motorlar
1.4, 1.5, 1.7, 1.8, 1.9, 2.1, 2.5, D/TD/TDİ dizel motorlar
1.4, 1.6, 2.0, 2.2 HDİ dizel motorlar
(Daha detaylı model ve motor kodları için kullanım kılavuzuna bakınız.)

KOD NO Code No	İÇERİK Details	PAKET/KOLİ Package/Box	FİYAT Price
RSA0030	36 pcs	1 / 10 adet	

13
PCS

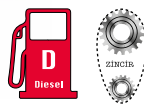

SENTE APARAT TAKIMI - FIAT

- FIAT, OPEL, FORD, SUZUKİ grubu dizel araçlarda triger kayışı/zinciri değişimi için komple aparat takımı
FIAT Benzinli: Punto, Panda, Idea, Doblo 1.3 JTD Multijet
OPEL: Agila, Corsa-C, Combo-C, Corsa-D, Astra-H, Tigre-B, Meriva 1.3 CDTi
SUZUKİ: Ingis, Wagon, Swift 1.3 CDTi
(Daha detaylı model ve motor kodları için kullanım kılavuzuna bakınız.)

KOD NO Code No	İÇERİK Details	PAKET/KOLİ Package/Box	FİYAT Price
RSA0022	13 pcs	1 / 10 adet	

4
PCS



SENTE APARAT TAKIMI - FIAT

- FIAT grubu benzinli ve dizel araçlarda triger kayışı/zinciri değişimi için komple aparat takımı
FIAT Brava, Bravo, Marea, Stilo Weekend, Multipla ve Palio Week-end (95-04)
Motorlar: 178B3.000, 182A4.00, 182A6.000, 182B6.000.
(Daha detaylı model ve motor kodları için kullanım kılavuzuna bakınız.)

KOD NO Code No	İÇERİK Details	PAKET/KOLİ Package/Box	FİYAT Price
RPC0022	4 pcs	1 / 10 adet	



16
PCS

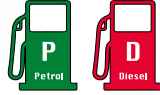

SENTE APARAT TAKIMI - FORD

- FORD grubu benzinli ve dizel araçlarda triger kayışı/zinciri değişimi için komple aparat takımı
C-MAX (07-12) / Courgar (98-01) / Courier(00-02) / Fiesta(95-12) / Focus(98-12)
Focus C-MAX(03-07) / Fusion(02-12) / Galaxy(06-12) / Grand C-MAX(10-12)
Kuga(08-12) / Maverick(01-07) / Mondeo(93-12) / Puma(97-02) / S-MAX(06-12)
Tourneo Connect(02-12) / Transit(06-11) / Transit Connect(02-12)
(Daha detaylı model ve motor kodları için kullanım kılavuzuna bakınız.)

KOD NO Code No	İÇERİK Details	PAKET/KOLİ Package/Box	FİYAT Price
RSA0050	16 pcs	1 / 10 adet	

12
PCS



YAĞ BASINÇ TEST KİTİ

- Aşınmış yağ pompaları ve motorları, yetersiz yağ basınç anahtarları ve uyarı göstergelerini teşhis etmekte kullanılır.
ÖLÇÜM ARALIĞI: 0-150 PSI; 0-10 kg/cm²; 0-10 Bar.

- ◆ ALFA ◆ MITSUBISHI ◆ AUDI ◆ NISSAN ◆ BMW ◆ OPEL
◆ CITROEN ◆ PEUGEOT ◆ DAIHATSU ◆ RENAULT ◆ FIAT
◆ ROVER ◆ FORD ◆ SAAB ◆ HONDA ◆ SKODA ◆ HYUNDAI
◆ SUBARU ◆ ISUZU ◆ SUZUKI ◆ JAGUAR ◆ TOYOTA
◆ LADA ◆ OPEL ◆ LANCIA ◆ VW ◆ MAZDA ◆ VOLVO
◆ MERCEDES-BENZ ◆ ZASTAVA

KOD NO Code No	İÇERİK Details	PAKET/KOLİ Package/Box	FİYAT Price
RYK0012	12 pcs	1 / 10 adet	

12
PCS



KOMPRESYON TEST KİTİ (DİZEL)

- Dizel araçlarda kompresyon ölçümü yapmak için test kiti. İçeriğinde bulunan enjektör ve kızdırma bujisi adaptörleri ile birçok araçta kullanılabilir.

- ◆ BMW ◆ HOLDEN ◆ NISSAN ◆ VAUXHALL ◆ CARBODIES
◆ ISUZU ◆ OPEL ◆ VOLKSWAGEN ◆ CITROEN ◆ LAND ROVER
◆ PEUGEOT ◆ VOLVO ◆ DACIA ◆ LEYLAND / DAF
◆ RENAULT ◆ DIAHATSU ◆ MAZDA ◆ ROVER ◆ FIAT
◆ MERCEDES-BENZ ◆ SEAT ◆ FORD ◆ MITSUSHI

KOD NO Code No	İÇERİK Details	PAKET/KOLİ Package/Box	FİYAT Price
RDK0012	12 pcs	1 / 10 adet	

3
PCS



KOMPRESYON TEST KİTİ (BENZİN)

- Benzinli araçlarda kompresyon ölçümü yapmak için test kiti.

KOD NO Code No	İÇERİK Details	PAKET/KOLİ Package/Box	FİYAT Price
RBK0003	3 pcs	1 / 10 adet	

5
PCS

FIAT - OPEL DİZEL SENTE APARATI

- FIAT 1.6JTD - 1.9JTD
- Vauxhall Dizel 1.9D CDTi (Kayışlı)
- Saab Dizel 1.9D T1D (Kayışlı)
- Vauxhall Modeller:
- Astra-H (04->) Vectra-C (04->)
- Signum (04->) Zafira-B (05->)
- Motorlar: Z19DT Z19DTH Z19DTL
- Saab Modelleri: 9-3 (04->) 9-5 (05->)
- Motorlar: Z19DT Z19DTH

KOD NO Code No	İÇERİK Details	PAKET/KOLİ Package/Box	FİYAT Price
ROT0101	5 pcs	1 / 10 adet	

6
PCS

FIAT 1.6-2.0 16V SENTE APARATI

- Fiat Eksantrik Kilitleme
- Fiat motor tipleri ; 178B3.000,
182A4.000, 182A6.000 Brava
182B6.000 Brava,Bravo, Marea,
Marea Weekend, Multipla, Palio, Stilo

KOD NO Code No	İÇERİK Details	PAKET/KOLİ Package/Box	FİYAT Price
ROT0108	6 pcs	1 / 10 adet	

6
PCS

FOCUS C-MAX SENTE APARATI

- Ford Focus, Mondeo Cmax 1.6 Ti-VCT
(2003->) 2.0 TDCi (2003->)
- Araçları eksantrik kilitleme aparatı
- Motor kodu G6DA, G6DB, G6DC 2003->
araçlarına uygundur.

KOD NO Code No	İÇERİK Details	PAKET/KOLİ Package/Box	FİYAT Price
ROT0107	6 pcs	1 / 10 adet	

5
PCS

FIAT 1.6-2.0 16V SENTE APARATI

- Fiat Eksantrik Kilitleme
- Fiat motor tipleri; 178B3.000,
182A4.000, 182A6.000 Brava
182B6.000 Brava, Bravo, Marea,
Marea Weekend, Multipla, Palio, Stilo

KOD NO Code No	İÇERİK Details	PAKET/KOLİ Package/Box	FİYAT Price
ROT0106	5 pcs	1 / 10 adet	



RENAULT KRANK KİTLEME

KOD NO Code No	İÇERİK Details	PAKET/KOLİ Package/Box	FİYAT Price
ROT0110	4 pcs	1 / 10 adet	



4
PCS



1.6 OPEL DİZEL SENTE APARATI

KOD NO Code No	İÇERİK Details	PAKET/KOLİ Package/Box	FİYAT Price
ROT0105	4 pcs	1 / 10 adet	

5
PCS

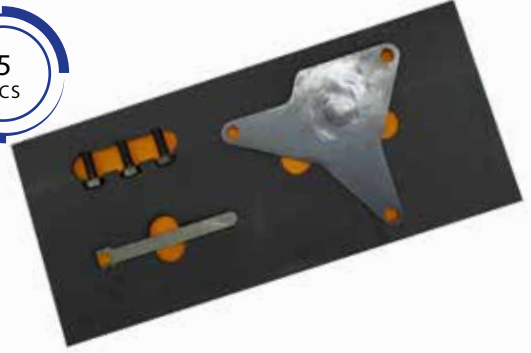

FIAT 1.4 MULTI AIR SENTE APARATI

- OEM Tools: 2000034400, 2000004500
Applications: Alfa Romeo; Giulietta (10-12)
MiTo (09-12), Fiat; Punto Evo (09-12)
Engine Codes: 940A2.000, 955A2.000
955A6.000, 955A7.000, 955A8.000

KOD NO Code No	İÇERİK Details	PAKET/KOLİ Package/Box	FİYAT Price
ROT0102	5 pcs	1 / 10 adet	

17
PCS



FORD GRUBU EKSANTRİK KİLİTLEME SET

- Ford grubu triger sente ve eksantrik kilitleme

KOD NO Code No	İÇERİK Details	PAKET/KOLİ Package/Box	FİYAT Price
ROT0103	17 pcs	1 / 10 adet	

2
PCS



VOLKSWAGEN T.S 1,2 EKSANTRİK KİLİTLEME SET

KOD NO Code No	İÇERİK Details	PAKET/KOLİ Package/Box	FİYAT Price
ROT0104	2 pcs	1 / 10 adet	

5
PCS



FIAT 1.4 8 VALF SENTE APARATI

KOD NO Code No	İÇERİK Details	PAKET/KOLİ Package/Box	FİYAT Price
ROT0109	5 pcs	1 / 10 adet	



FIAT 1.3 MULTIJET EKSANTRİK KİTLEME

KOD NO Code No	İÇERİK Details	PAKET/KOLİ Package/Box	FİYAT Price
ROT0111	4 pcs	1 / 10 adet	

20
PCS

RADYATÖR TEST KİTİ

- Araçlarda soğutma sistemi basıncını ölçmek için kullanılır.
- İçerdiği çeşitli adaptörler sayesinde birçok araçta kullanılabilir.

KOD NO Code No	İÇERİK Details	PAKET/KOLİ Package/Box	FİYAT Price
RRT0119	20 pcs	1 / 10 adet	

32
PCS

RADYATÖR TEST KİTİ

- Araçlarda soğutma sistemi basıncını ölçmek için kullanılır.
- İçerdiği çeşitli adaptörler sayesinde birçok araçta kullanılabilir.

KOD NO Code No	İÇERİK Details	PAKET/KOLİ Package/Box	FİYAT Price
RRT0120	32 pcs	1 / 10 adet	

46
PCS

ENJEKSİYON TEST SETİ

- Benzinli motorlar için enjeksiyon test kiti

KOD NO Code No	İÇERİK Details	PAKET/KOLİ Package/Box	FİYAT Price
RGK1020	46 pcs	1 / 10 adet	

12
PCS

DİZEL ENJEKTÖR AKIŞ TEST KİTİ

- Yıpranmış ve hasar görmüş enjektörleri kolayca tespit eder..
- 6 silindire kadar rail enjektör sistemi ile çalışan dizel araçlarda geri dönen yakıt akışını ölçmekte kullanılır.

KOD NO Code No	İÇERİK Details	PAKET/KOLİ Package/Box	FİYAT Price
RCR1060	12 pcs	1 / 10 adet	



FREN PİSTONU - DİSK AYIRICI

- Fren pistonunun güvenli bir şekilde sökülmesi için kullanılır.

KOD NO Code No	ÖLÇÜ mm	PAKET/KOLİ Package/Box	FİYAT Price
RDA0052	22x80 mm	10 / 10 adet	

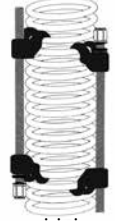

AMORTİSÖR YAYI ÇEKİRME

- Amortisör yaylarının güvenli bir şekilde sökülmesi için kullanılır.

KOD NO Code No	ÖLÇÜ mm	PAKET/KOLİ Package/Box	FİYAT Price
RAC0117	270 mm	1 / 10 adet	



TRİGER KAYIŞI GERGİ ÖLÇME

- Triger kayışlarının gerginliğini ölçmek için kullanılır.
- Hassas ayar vidası, çift taraflı skala.

KOD NO Code No	İÇERİK Details	PAKET/KOLİ Package/Box	FİYAT Price
RKG1020	1 pcs	1 / 10 adet	



AKÜ BOMBESİ

- Akü içindeki elektrolit yoğunluğunu ölçmek için kullanılır.

KOD NO Code No	İÇERİK Details	PAKET/KOLİ Package/Box	FİYAT Price
RAB0901	1 pcs	1 / 10 adet	



ANTİFİRİZ BOMBESİ

- Radyatör içindeki antifiriz yoğunluğunu ölçmek için kullanılır.

KOD NO Code No	İÇERİK Details	PAKET/KOLİ Package/Box	FİYAT Price
RFB0906	1 pcs	1 / 10 adet	



AKÜ BOMBESİ

- Akü içindeki elektrolit yoğunluğunu ölçmek için kullanılır.

KOD NO Code No	İÇERİK Details	PAKET/KOLİ Package/Box	FİYAT Price
RAB0906	1 pcs	1 / 10 adet	



GARANTİ
KAPSAM DIŐI



OTO KONTROL KALEMİ

- 780 mm kısaçalı kablo.
- 6-24V sistemlerin kontrolü için kullanılır.
- Vakum teŐhir ambalajlı.

KOD NO Code No	ÖLÇÜ mm	PAKET/KOLİ Package/Box	FİYAT Price
ROK0960	3 - 48V	1 / 10 adet	

GARANTİ
KAPSAM DIŐI



OTO KONTROL KALEMİ

- 780 mm kısaçalı kablo.
- 6-24V sistemlerin kontrolü için kullanılır.
- Vakum teŐhir ambalajlı.

KOD NO Code No	ÖLÇÜ mm	PAKET/KOLİ Package/Box	FİYAT Price
RKK0801	6 - 24V	1 / 10 adet	



DÖŐEME KLİPS TORNAVİDASI

- DöŐemeleri tutan klipslerin sökölmesinde kullanılır.

KOD NO Code No	ÖLÇÜ mm	PAKET/KOLİ Package/Box	FİYAT Price
RDS0175	175 mm	12 / 36 adet	



DÖŐEME KLİPS SÖKME PENSESİ

- DöŐemeleri tutan klipslerin sökölmesinde kullanılır.
- Yaylı mekanizması kullanım kolaylıđı sađlar.

KOD NO Code No	ÖLÇÜ mm	PAKET/KOLİ Package/Box	FİYAT Price
REP0013	230 mm	12 / 36 adet	



MEKANİKÇİ STETESKOP

- Motorun içindeki sorunları tespit etmek için kullanılır.
- Metal yapısı ile çok daha hassas neticeler elde edilir.
- Piston vurmaları, aşınmış dişlileri, arızalı valfleri, devirdaim pompa arızaları, yıpranmış contaları ve arızalanmış bilyaların kolaylıkla tespitini sađlar.

KOD NO Code No	İÇERİK Details	PAKET/KOLİ Package/Box	FİYAT Price
RMS2011	1 pcs	1 / 10 adet	



MEKANİKÇİ STETESKOP

- Motorun içindeki sorunları tespit etmek için kullanılır.
- Piston vurmaları, aşınmış dişlileri, arızalı valfleri, devirdaim pompa arızaları, yıpranmış contaları ve arızalanmış bilyaların kolaylıkla tespitini sađlar.

KOD NO Code No	İÇERİK Details	PAKET/KOLİ Package/Box	FİYAT Price
RMS2012	1 pcs	1 / 10 adet	



HİDROLİK TEST KALEMİ

- Fren hidrolik sıvısı kalite ölçümü için kullanılır.
- Renkli diyot lambalar.

KOD NO Code No	ÖLÇÜ mm	PAKET/KOLİ Package/Box	FİYAT Price
RFY0512	230 mm	1 / 5 adet	
RFY0515	250 mm	1 / 5 adet	



ROTİL ÇEKTİRME

- Rotlar üzerindeki bilyalı mafsal millerinin çıkarılmasında kullanılır.

KOD NO Code No	ÖLÇÜ mm	PAKET/KOLİ Package/Box	FİYAT Price
RRC0180	18 mm	10 / 80 adet	
RRC0290	29 mm	10 / 60 adet	
RRC0400	40 mm	5 / 30 adet	
RRC0460	46 mm	5 / 30 adet	



ROTİL ÇEKTİRME

- Mat krom kaplama.
- Çektirme yüksekliği: 20-50 mm.
- Rotlar üzerindeki bilyalı mafsal millerinin çıkarılmasında kullanılır.

KOD NO Code No	ÖLÇÜ mm	PAKET/KOLİ Package/Box	FİYAT Price
RRC0160	18-20 mm	1 / 25 adet	



ROTİL ÇEKTİRME

- Mat krom kaplama.
- Çektirme yüksekliği: 12-50 mm.
- Rotlar üzerindeki bilyalı mafsal millerinin çıkarılmasında kullanılır.

KOD NO Code No	ÖLÇÜ mm	PAKET/KOLİ Package/Box	FİYAT Price
RRC0190	22 mm	1 / 10 adet	

DIŞ RULMAN ÇEKTİRME

- Mat krom kaplama.
- İndüksiyon ile sertleştirilmiş kollar.

KOD NO Code No	ÖLÇÜ mm	PAKET/KOLİ Package/Box	FİYAT Price
RRC0136	30-50 mm	1 / 50 adet	
RRC0137	50-75 mm	1 / 25 adet	
RRC0138	75-105 mm	1 / 15 adet	





ROT KOLU APARATI - BİLYALI

Made in Turkey

- Rot kollarını sökmek için kullanılır.
- 1/2" sürücülü aletler veya 27 mm anahtar ile kullanılır.

KOD NO Code No	ÖLÇÜ mm	PAKET/KOLİ Package/Box	FİYAT Price
RRK0250	28-35 mm	1 / 10 adet	
RRK0400	35-45mm	1 / 10 adet	



ROT KOLU APARATI - FREZELİ

Made in Turkey

- Rot kollarını sökmek için kullanılır.
- 1/2" sürücülü aletler veya 27 mm anahtar ile kullanılır.

KOD NO Code No	ÖLÇÜ mm	PAKET/KOLİ Package/Box	FİYAT Price
RDK0250	28-35 mm	1 / 10 adet	
RDK0400	35-45mm	1 / 10 adet	

1/2" 17 mm



1/2" BİJON LOKMA ANAHTARI

- Mercedes S-Class otomobillerde özel jant somunlarının sökölüp takılması için kullanılır.

KOD NO Code No	ÖLÇÜ mm	PAKET/KOLİ Package/Box	FİYAT Price
RML0017	78 mm	12 / 48 adet	

1/2"



CHROME
CrV
VANADIUM

4
PCS



DÖNER SAPLI ADAPTÖRLÜ BİJON

- Altı köşe civatalar için lokma anahtarlar.
- Parlak krom kaplı sertleştirilmiş kaliteli chrome vanadium çeliği.
- Deri fermuarlı çantası ile yer kaplamaz

KOD NO Code No	İÇERİK Details	PAKET/KOLİ Package/Box	FİYAT Price
RAB1723	4 pcs	35 / 70 adet	



BALANS PENSESİ

- Yüksek vasıflı chrome vanadium çeliğinden üretilmiştir.
- Mat krom kaplama.
- PVC sap

KOD NO Code No	ÖLÇÜ mm	PAKET/KOLİ Package/Box	FİYAT Price
RBP0250	250 mm	12 / 48 adet	



ZİNCİRLİ BORU ANAHTARI

Made in Turkey

- Her iki yönde emniyetli kavrayarak çalışma imkanı sağlar.
- Parlak krom kaplama yüzeyi.

KOD NO Code No	ÖLÇÜ mm	PAKET/KOLİ Package/Box	FİYAT Price
RZB0012	300 mm	6 / 36 adet	



VİDALI YAĞ FİLTRE ANAHTARI

- Ayarlanabilir ağız sayesinde birçok boy ve ölçüye uyar.

KOD NO Code No	ÖLÇÜ mm	PAKET/KOLİ Package/Box	FİYAT Price
RVF6111	60-110 mm	25 / 72 adet	
RVF6110	Yedek	10 adet	



ÇEMBERLİ YAĞ FİLTRE ANAHTARI

- Ayarlanabilir ağız sayesinde birçok boy ve ölçüye uyar.
- Plastik daldırma sapları ile konforlu tutuş sağlar.
- Standart yağ filtrelerinin sökölüp takılmasında kullanılır.

KOD NO Code No	ÖLÇÜ mm	PAKET/KOLİ Package/Box	FİYAT Price
RFS6073	60 - 80 mm	12 / 72 adet	
RFS7385	80 - 110 mm	12 / 72 adet	



ÇİFT ZİNCİRLİ FİLTRE ANAHTARI

- Her iki yönde emniyetli kavrayarak çalışma imkanı sağlar.
- Mat krom kaplama yüzey.

KOD NO Code No	ÖLÇÜ mm	PAKET/KOLİ Package/Box	FİYAT Price
RFA0173	60-110 mm	6 / 24 adet	
RFA6016	60-160 mm	6 / 24 adet	



ZİNCİRLİ FİLTRE ANAHTARI

Made in
Turkey

- Her iki yönde emniyetli kavrayarak çalışma imkanı sağlar.
- Parlak krom kaplama yüzey.

KOD NO Code No	ÖLÇÜ mm	PAKET/KOLİ Package/Box	FİYAT Price
RZB0009	225 mm	6 / 36 adet	



KAYIŞLI FİLTRE ANAHTARI

Made in
Turkey

- Üzerinde çalıştığı yüzey iyi koruma sağlar.
- Parlak krom kaplama yüzey.

KOD NO Code No	ÖLÇÜ mm	PAKET/KOLİ Package/Box	FİYAT Price
RKB0009	225 mm	6 / 60 adet	



KAYIŞLI FİLTRE ANAHTARI

Made in
Turkey

- Üzerinde çalıştığı yüzey iyi koruma sağlar.
- Parlak krom kaplama yüzey.

KOD NO Code No	ÖLÇÜ mm	PAKET/KOLİ Package/Box	FİYAT Price
RKB0012	275 mm	5 / 30 adet	



YAĞ FİLTRE PENSESİ

Made in
Turkey

- Ayarlanabilir ağız sayesinde birçok boy ve ölçüye uyar.
- Plastik daldırma sapları ile konforlu tutuş sağlar.

KOD NO Code No	ÖLÇÜ mm	PAKET/KOLİ Package/Box	FİYAT Price
RFP6090	60-90 mm	6 / 60 adet	
RFP8515	85-115 mm	12 / 48 adet	



3 KOLLU YAĞ FİLTRE ANAHTARI - BÜYÜK

- Ticari araçların yağ filtrelerini sökmek için kullanılır.
- Hava kurutucu kartuşlar içinde kullanılabilir.
- Kamyon, otobüs vb. araçlar içindir.

KOD NO Code No	ÖLÇÜ mm	PAKET/KOLİ Package/Box	FİYAT Price
RFA9165	95-165 mm	1 / 12 adet	



LOKMA TİPİ YAĞ FİLTRE ANAHTARI

- RFT2706 - Mercedes A Class - Ford TOCI
- RFT3206 - Opel Astra G - Zafira - Corsa
- RFT3206 - BMW24W - Ford Dura Torque

KOD NO Code No	ÖLÇÜ mm	KENAR SAYISI	PAKET/KOLİ Package/Box	FİYAT Price
RFT2706	27 mm	6	1 / 24 adet	
RFT3206	32 mm	6	1 / 24 adet	
RFT3606	36 mm	6	1 / 24 adet	



3 KOLLU YAĞ FİLTRE ANAHTARI - KÜÇÜK

- Araçların yağ filtrelerini sökmek için kullanılır.
- Hava kurutucu kartuşlar içinde kullanılabilir.

KOD NO Code No	ÖLÇÜ mm	PAKET/KOLİ Package/Box	FİYAT Price
RFA6110	60-110 mm	1 / 12 adet	



TAS TİPİ YAĞ FİLTRE ANAHTARI

KOD NO Code No	ÖLÇÜ mm	KENAR SAYISI	ARAÇLAR Cars	FİYAT Price
RFT6514	65 mm	14	JAPON	
RFT6606	66 mm	6	FIAT	
RFT7612	76 mm	12	FORD-RENAULT-PEUGEOT	
RFT7614	76 mm	14	ALMAN	
RFT7414	74 mm	14	VW - AUDI	
RFT8616	86 mm	16	BMW - VOLVO	



KARTER TAPA ANAHTARI

- Siyah fosfor kaplama yüzeyi.
- Karter tapa somunlarının montajında ve sökülmesinde kullanılır.

KOD NO Code No	ÖLÇÜ mm	PAKET/KOLİ Package/Box	FİYAT Price
RKT0215	8 x 10 mm	1 / 10 adet	



AKIŞ KESME APARATI

- Yağ sızıntılarını engellemek için kullanılır.
- Maximum çene genişliği: 25.4 mm.
- Özellikle fren, yakıt ve soğutma sistemi hortumlarında kullanılır.

KOD NO Code No	ÖLÇÜ mm	PAKET/KOLİ Package/Box	FIYAT Price
RHK0100	310 mm	10 / 40 adet	



FLEX HORTUM KELEPÇESİ

- Ulaşılması zor ve uzak noktalarda kolaylık sağlar.
- Isıtma sistemi ve radyatör hortumlarının yaylı bant kelepçelerinin sökülmesinde kullanılır.

KOD NO Code No	ÖLÇÜ mm	PAKET/KOLİ Package/Box	FIYAT Price
RKP3050	260 mm	12 / 60 adet	



HORTUM KELEPÇE PENSESİ

- Hortum kelepçelerinin sökülmesi ve takılmasında kullanılır.
- Vakum hortumları, soğutma ve yakıt sistemlerinde kullanılan kulak tipi kelepçeler için.

KOD NO Code No	ÖLÇÜ mm	PAKET/KOLİ Package/Box	FIYAT Price
RKP3049	220 mm	6 / 36 adet	



HORTUM KELEPÇE PENSESİ

- Hortum kelepçelerinin sökülmesi ve takılmasında kullanılır.
- Vakum hortumları, soğutma ve yakıt sistemlerinde kullanılan kulak tipi kelepçeler için.

KOD NO Code No	ÖLÇÜ mm	PAKET/KOLİ Package/Box	FIYAT Price
RKP0230	230 mm	6 / 36 adet	

AĞIR TİP BİJON ANAHATLAR



- Mat krom kaplama

KOD NO Code No	ÖLÇÜ mm	PAKET/KOLİ Package/Box	FIYAT Price
RBA3233	32 x 33 mm	1 / 10 adet	





EGZUZ KELEPÇE AYIRICI

- 17 mm anahtar ile kullanılır.
- Manifold ve egzozu birbirine bağlayan yaylı kelepçenin takılıp sökülmesi için kullanılır.

KOD NO Code No	ÖLÇÜ mm	PAKET/KOLİ Package/Box	FİYAT Price
REK0115	17x145 mm	1 / 6 adet	



SÜBAP KEÇE PENSESİ

- Sübap mili segmanlarının ve sübap yaylarının çıkartılmasında ve yerleştirilmesinde kullanılır.
- Vw, Audi, BMW, Opel, Ford, Nissan marka arabalarda kullanılır.

KOD NO Code No	ÖLÇÜ mm	PAKET/KOLİ Package/Box	FİYAT Price
RSP0133	275 mm	12 / 36 adet	



PİSTON ÇEMBERLERİ

- Cırcır mekanizmalı esnek piston çemberi.
- Özel yay çeliği, sıkma kolu ile birlikte verilir.
- Pistonların silindirlere yerleştirilmesinde, piston çemberlerini sabit ve merkezde tutmaya yarar.

KOD NO Code No	Ø mm	ÖLÇÜ mm	PAKET/KOLİ Package/Box	FİYAT Price
RPC0030	57-125 mm	75 mm	1 / 24 adet	
RPC0040	90-175 mm	75 mm	1 / 24 adet	
RPC0060	90-175 mm	165 mm	1 / 24 adet	



RX SERİSİ FLEX MIKNATIS

Made in
Turkey

KOD NO Code No	ÖLÇÜ mm	PAKET/KOLİ Package/Box	FİYAT Price
RFM1600	1600 gr	12 / 120 adet	



RX SERİSİ FLEX MIKNATIS

Made in
Turkey

KOD NO Code No	ÖLÇÜ mm	PAKET/KOLİ Package/Box	FİYAT Price
RFM0600	600 gr	12 / 120 adet	

13
PCS



ALTERNATÖR KASNAK SETİ

- Alternatörde bulunan V(dişli) kayış kasmağının sökölüp takılması için.
- BMW, Fiat, Audi, Ford, Mercedes, Renault, Seat, Volkswagen, Porche araçlarında kullanılır.

KOD NO Code No	İÇERİK Details	PAKET/KOLİ Package/Box	FİYAT Price
RAS0130	13 pcs	1 / 10 adet	

1/2"



CHROME
CrV
VANADIUM



1/2" TORX ALTERNATÖR LOKMASI

- Alternatörde bulunan dişli kayış kasmağının sökölüp takılmasında kullanılır.
- Parlak krom kaplı chrome vanadium gövde

KOD NO Code No	ÖLÇÜ mm	PAKET/KOLİ Package/Box	FİYAT Price
RAL0T50	T50	10 / 120 adet	

1/2"



CHROME
CrV
VANADIUM

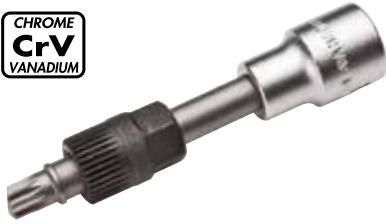

1/2" TORX ALTERNATÖR LOKMASI

- Alternatörde bulunan dişli kayış kasmağının sökölüp takılmasında kullanılır.
- Parlak krom kaplı chrome vanadium gövde

KOD NO Code No	ÖLÇÜ mm	PAKET/KOLİ Package/Box	FİYAT Price
RAL0M10	M10	10 / 120 adet	



KASNAK ÇEKTİRME

- Kasnakları çıkarmak için kullanılır.

KOD NO Code No	ÖLÇÜ mm	PAKET/KOLİ Package/Box	FİYAT Price
RKC0081	45 x 175	1 / 3 adet	

3/8"



CHROME
CrV
VANADIUM



Miknatsız



KISA

3/8" BUJİ ANAHTARI - 12 KÖŞE

- Mat krom kaplı sertleştirilmiş kaliteli chrome vanadium çeliği.
- Araba motorlarındaki bujiler için lokma anahtar.

KOD NO Code No	ÖLÇÜ mm	PAKET/KOLİ Package/Box	FİYAT Price
RBA3809	90 mm	25 / 300 adet	

3/8"



CHROME
CrV
VANADIUM



Miknatsız



UZUN

3/8" BUJİ ANAHTARI - 12 KÖŞE

- Mat krom kaplı sertleştirilmiş kaliteli chrome vanadium çeliği.
- Araba motorlarındaki bujiler için lokma anahtar.

KOD NO Code No	ÖLÇÜ mm	PAKET/KOLİ Package/Box	FİYAT Price
RBA3825	250 mm	25 / 300 adet	



KURT AĞZI - ÇİFT YÖN

- Dar alanlarda rahat kullanım için dar çene ve çift yönlü çekme.
- Dövülmüş krom molibden çeliği, çinko kaplı yüzey.

KOD NO Code No	ÖLÇÜ mm	PAKET/KOLİ Package/Box	FİYAT Price
RKC0205	5 - 2 ton	1 / 20 adet	



KURT AĞZI - TEK YÖN

- Dar alanlarda rahat kullanım için dar çene.
- Dövülmüş krom molibden çeliği, çinko kaplı yüzey.

KOD NO Code No	ÖLÇÜ mm	PAKET/KOLİ Package/Box	FİYAT Price
RKC0305	5 ton	1 / 20 adet	



KURT AĞZI - ASİMETRİK ÇENE

- Asimetrik çene, tek yönlü çekme.
- Dövülmüş krom molibden çeliği, çinko kaplı yüzey.

KOD NO Code No	ÖLÇÜ mm	PAKET/KOLİ Package/Box	FİYAT Price
RKC0405	3 ton	1 / 20 adet	



KURT AĞZI - YASSI TİP

- Yassı yapı, uzun alet ömrü, tek yönlü çekme.
- Dövülmüş krom molibden çeliği, çinko kaplı yüzey.

KOD NO Code No	ÖLÇÜ mm	PAKET/KOLİ Package/Box	FİYAT Price
RKC0505	3 ton	1 / 20 adet	



KAPORTACI EĞE KOLU

- Hafif metal alaşımli tutamak.
- Eğe hariç.

KOD NO Code No	ÖLÇÜ mm	PAKET/KOLİ Package/Box	FİYAT Price
RKE1400	350 mm	1 / 20 adet	

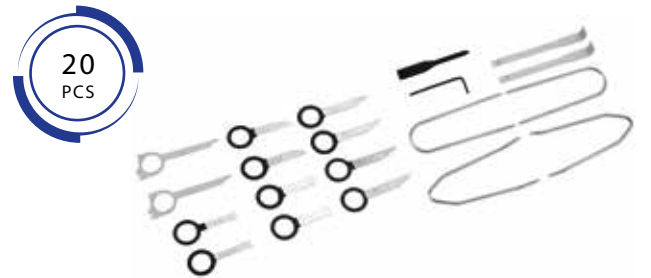

RADYO ÇIKARMA SETİ

- Çeşitli tipte araç radyolarını sökmek için kullanılır.
- Plastik kılıflı set.

KOD NO Code No	İÇERİK Details	PAKET/KOLİ Package/Box	FİYAT Price
RRS1020	20 pcs	1 / 10 adet	



1/2"



1/2" DİZEL ENJEKTÖR LOKMASI

- Siyah mangan fosfat kaplı malzeme.
- Dizel enjektörlerin takılması ve sökülmesi için kullanılır.

KOD NO Code No	ÖLÇÜ mm	PAKET/KOLİ Package/Box	FİYAT Price
REL0012	27x80 mm	12/72 adet	

1/2"



1/2" DİZEL ENJEKTÖR LOKMASI

- Siyah mangan fosfat kaplı malzeme.
- Dizel enjektörlerin takılması ve sökülmesi için kullanılır.

KOD NO Code No	ÖLÇÜ mm	PAKET/KOLİ Package/Box	FİYAT Price
REL0013	22x80 mm	10 / 100 adet	

1/2"



1/2" DİZEL ENJEKTÖR LOKMASI

- Siyah mangan fosfat kaplı malzeme.
- Dizel enjektörlerin takılması ve sökülmesi için kullanılır.

KOD NO Code No	ÖLÇÜ mm	PAKET/KOLİ Package/Box	FİYAT Price
REL0014	22x110 mm	10 / 100 adet	



1/2" ENJEKTÖR LOKMASI

- Yassı yapı, uzun alet ömrü, tek yönlü çekme.
- Dövülmüş krom molibden çeliği, çinko kaplı yüzey.

KOD NO Code No	ÖLÇÜ mm	PAKET/KOLİ Package/Box	FİYAT Price
REL0017	17 mm	1 / 10 adet	
REL0019	19 mm	1 / 10 adet	

1/2"



1/2" OKSİJEN LAMBDA SENSÖR LOKMASI

- Mat krom kaplı malzeme
- Isıtılmı ve ısıtılmı oksijen sensörlerinin takılıp sökülme-
sinde kullanılır.

KOD NO Code No	ÖLÇÜ mm	PAKET/KOLİ Package/Box	FİYAT Price
REL0015	22x110 mm	10 / 100 adet	



GENEL BAKIM ALETLERİ





YENİ ÜRÜN



GARAJ SERVİS KRİKOSU

- 2 adet döner, 2 adet sabit teker.
- 130-465 mm kaldırma aralığı.
- Ürün Ölçüleri: 572x328x175 mm

KOD NO Code No	ÖLÇÜ mm	PAKET/KOLİ Package/Box	FIYAT Price
RAK3050	130-465 mm	1 adet	

YENİ ÜRÜN



GARAJ SERVİS KRİKOSU

(DÜŞÜK PROFİL)

- 2 adet döner, 2 adet sabit teker.
- 80-515 mm kaldırma aralığı.
- Ürün Ölçüleri: 722x328x150 mm

KOD NO Code No	ÖLÇÜ mm	PAKET/KOLİ Package/Box	FIYAT Price
RAK3150	80-515 mm	1 adet	



HİDROLİK ŞİŞE KRİKO



KOD NO Code No	KAPASİTE Capacity	ÖLÇÜ mm	PAKET/KOLİ Package/Box	FIYAT Price
RHK0200	2 TON	181 - 345 mm	6 adet	

3
ton



PROFESYONEL GARAJ SERVİS KRİKOSU

- 2 adet döner, 2 adet sabit teker.
- 145-520 mm kaldırma aralığı.
- Ürün Ölçüleri: 700x346x180 mm

KOD NO Code No	ÖLÇÜ mm	PAKET/KOLİ Package/Box	FİYAT Price
RAK3000	145-520 mm	1 adet	

3
ton



[DÜŞÜK PROFİL]

PROFESYONEL GARAJ SERVİS KRİKOSU

- 2 adet döner, 2 adet sabit teker.
- 98-535 mm kaldırma aralığı.
- Ürün Ölçüleri: 780x345x170 mm

KOD NO Code No	ÖLÇÜ mm	PAKET/KOLİ Package/Box	FİYAT Price
RAK3100	98-535 mm	1 adet	

3
ton



GARAJ SERVİS KRİKOSU

- 2 adet döner, 2 adet sabit teker.
- 140-525 mm kaldırma aralığı.
- Ürün Ölçüleri: 1150x410x240 mm

KOD NO Code No	ÖLÇÜ mm	PAKET/KOLİ Package/Box	FİYAT Price
RPK3000	140-525 mm	1 adet	





0,5
ton



ŞANZIMAN KRİKOSU

KOD NO Code No	ÖLÇÜ mm	PAKET/KOLİ Package/Box	FIYAT Price
RSK1200	0,5 ton 1135-1950 mm	1 adet	

2
ton



MOTOR KALDIRMA VİNCİ

KOD NO Code No	ÖLÇÜ mm	PAKET/KOLİ Package/Box	FIYAT Price
RMV2000	2 ton 25-2000 mm	1 adet	



ARAÇ SEPHASI

- Geniş tabanı ile yere tam tutunma.
- Emniyet pimi.

KOD NO Code No	KAPASİTE Capacity	ÖLÇÜ mm	PAKET/KOLİ Package/Box	FIYAT Price
RAS3001	3 TON	285 - 425 mm	2 adet	
RAS6001	6 TON	390 - 605 mm	2 adet	







GRES POMPASI

- 400 bar besleme basıncı.
- Metal borulu, elektrostatik mat toz boyalı sac gövde.

KOD NO Code No	KAPASİTE Capacity	PAKET/KOLİ Package/Box	FİYAT Price
RGP0101	500 cc	1 / 20 adet	

GARANTİ
KAPSAM DIŞI



GRES POMPA HORTUM UCU

KOD NO Code No	ÖLÇÜ mm	PAKET/KOLİ Package/Box	FİYAT Price
RGU4000	Çene Adeti 4	25 adet	

GARANTİ
KAPSAM DIŞI



PROFESYONEL YAĞDANLIK

- Elektrostatik boyalı sac gövde
- Ergonomik yapı, katlanabilir hortum

KOD NO Code No	ÖLÇÜ mm	PAKET/KOLİ Package/Box	FİYAT Price
RPY0300	300 mm	1/90 adet	
RPY0500	500 mm	1/60 adet	
RPY0750	750 mm	1/50 adet	



PROFESYONEL LASTİK ŞİŞİRME TABANCASI

- PSİ / BAR baskılı gösterge.

KOD NO Code No	KAPASİTE Capacity	PAKET/KOLİ Package/Box	FİYAT Price
RLS0120	0-151 PSI	50 adet	



PROFESYONEL LASTİK ŞİŞİRME TABANCASI

- PSİ / BAR baskılı gösterge.
- Döküm gövde.

KOD NO Code No	KAPASİTE Capacity	PAKET/KOLİ Package/Box	FİYAT Price
RLS0310	0-250 PSI	50 adet	

EKO LASTİK ŞİŞİRME TABANCASI

- PSİ / BAR baskılı gösterge.
- Döküm gövde.

KOD NO Code No	KAPASİTE Capacity	PAKET/KOLİ Package/Box	FİYAT Price
RLS1040	170-12 mm	50 adet	



LASTİK ŞİŞİRME JAKI

- Krom kaplama çelik gövde.
- Tutum kolaylığı sağlayan ergonomik kauçuk sap.

KOD NO Code No	ÖLÇÜ mm	PAKET/KOLİ Package/Box	FİYAT Price
RLS0030	300 mm	50 adet	



LASTİK HAVA BASINÇ ÖLÇER

- Krom kaplama çelik gövde.
- Ölçüm göstergeli.

KOD NO Code No	ÖLÇÜ mm	PAKET/KOLİ Package/Box	FİYAT Price
RHB0300	300 mm	50 adet	



HAVA TABANCASI UZUN

KOD NO Code No	KAPASİTE Capacity	PAKET/KOLİ Package/Box	FİYAT Price
RHT0110	100 mm	10 adet	





GARANTİ
KAPSAM DIŞI



1/4 UNIVERSAL LOKMA

- 7mm - 19mm ölçüleri arası kullanılır.
- Zaman ve yerden tasarruf sağlar.

KOD NO Code No	KAPASİTE Capacity	PAKET/KOLİ Package/Box	FİYAT Price
RMS1400	7-13 mm	12 / 60 adet	

GARANTİ
KAPSAM DIŞI



1/2 UNIVERSAL LOKMA

- 13mm - 32mm ölçüleri arası kullanılır.
- Zaman ve yerden tasarruf sağlar.

KOD NO Code No	KAPASİTE Capacity	PAKET/KOLİ Package/Box	FİYAT Price
RMS1200	13-32 mm	12 / 60 adet	

10
PCS



1/2 SPIRAL LOKMA SETİ

- Manganez fosfat kaplı yüzey.
- Aşınmış civataların sökülmesinde kullanılan özel lokma seti.

KOD NO Code No	İÇERİK Detaylar	PAKET/KOLİ Package/Box	FİYAT Price
RSL1019	10 pcs	1 / 12 adet	

4
PCS



SAPLAMA LOKMA ANAHTAR SETİ

- İÇERİK: 6, 8, 10, 12 mm

KOD NO Code No	İÇERİK Detaylar	PAKET/KOLİ Package/Box	FİYAT Price
RSS0280	4 pcs	6 / 120 adet	

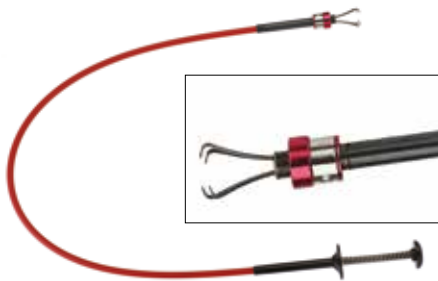

MİKNATISLI FLEX VİDA TUTUCU

- Ulaşılması zor yerlerdeki metal ve diğer parçaları yakalamak için 4 kısıklı ve mıknatıslı uç.

KOD NO Code No	ÖLÇÜ mm	PAKET/KOLİ Package/Box	FİYAT Price
RFT6000	600 mm	4 / 40 adet	

3
PCS



CONTA ÇEKTİRME SETİ

KOD NO Code No	İÇERİK Detaylar	PAKET/KOLİ Package/Box	FİYAT Price
RKC0192	3 pcs	10 / 40 adet	

24 PARÇA HASARLI DİŞ ONARIM SETİ



- Otomotiv ve hobi kullanım için.
- Hasarlı ve yıpranmış dişler için tamir seti.

KOD NO Code No	ÖLÇÜ mm	PAKET/KOLİ Package/Box	FIYAT Price
RHK5008	5mm	1 / 10 adet	

24 PARÇA HASARLI DİŞ ONARIM SETİ



- Otomotiv ve hobi kullanım için.
- Hasarlı ve yıpranmış dişler için tamir seti.

KOD NO Code No	ÖLÇÜ mm	PAKET/KOLİ Package/Box	FIYAT Price
RHK6010	6mm	1 / 10 adet	

24 PARÇA HASARLI DİŞ ONARIM SETİ



- Otomotiv ve hobi kullanım için.
- Hasarlı ve yıpranmış dişler için tamir seti.

KOD NO Code No	ÖLÇÜ mm	PAKET/KOLİ Package/Box	FIYAT Price
RHK8125	8mm	1 / 10 adet	

19 PARÇA HASARLI DİŞ ONARIM SETİ



- Otomotiv ve hobi kullanım için.
- Hasarlı ve yıpranmış dişler için tamir seti.

KOD NO Code No	ÖLÇÜ mm	PAKET/KOLİ Package/Box	FIYAT Price
RHK1015	10mm	1 / 10 adet	

14 PARÇA HASARLI DİŞ ONARIM SETİ



- Otomotiv ve hobi kullanım için.
- Hasarlı ve yıpranmış dişler için tamir seti.

KOD NO Code No	ÖLÇÜ mm	PAKET/KOLİ Package/Box	FIYAT Price
RHK1217	12mm	12 / 120 adet	



TERS KILAVUZ SETİ

- Kırılmış civata ve vidaların sökülmesinde kullanılır.
- Krom molibden çeliğinden üretilmiştir.

KOD NO Code No	İÇERİK Detalis	PAKET/KOLİ Package/Box	FIYAT Price
RVS1050	5 pcs	25 / 10 adet	



DÜZ UÇLU BİZ

- Otomotiv ve hobi kullanım için.
- Birçok çekme ve işaretleme işlerinde kullanılır.

KOD NO Code No	ÖLÇÜ mm	PAKET/KOLİ Package/Box	FİYAT Price
RXB0100	250 mm	1 / 12 adet	



45 DERECE UÇLU BİZ

- Otomotiv ve hobi kullanım için.
- Birçok çekme ve işaretleme işlerinde kullanılır.

KOD NO Code No	ÖLÇÜ mm	PAKET/KOLİ Package/Box	FİYAT Price
RXB0145	250 mm	1 / 12 adet	



90 DERECE UÇLU BİZ

- Otomotiv ve hobi kullanım için.
- Birçok çekme ve işaretleme işlerinde kullanılır.

KOD NO Code No	ÖLÇÜ mm	PAKET/KOLİ Package/Box	FİYAT Price
RXB0190	250 mm	1 / 12 adet	



KANCA UÇLU BİZ

- Otomotiv ve hobi kullanım için.
- Birçok çekme ve işaretleme işlerinde kullanılır.

KOD NO Code No	ÖLÇÜ mm	PAKET/KOLİ Package/Box	FİYAT Price
RXB0360	250 mm	1 / 12 adet	



TELESKOBİK AYNA

- Otomotiv ve hobi kullanım için.

KOD NO Code No	ÖLÇÜ mm	PAKET/KOLİ Package/Box	FİYAT Price
RFA0039	250 mm	1 / 12 adet	



TELESKOBİK AYNA

- Otomotiv ve hobi kullanım için.

KOD NO Code No	ÖLÇÜ mm	PAKET/KOLİ Package/Box	FİYAT Price
RFA0033	250 mm	1 / 12 adet	

CAM VANTUZU

- Bombeli ve oto camlar için vantuz.
- Kaldırma kapasitesi 40kg'dır.

KOD NO Code No	ÖLÇÜ mm	PAKET/KOLİ Package/Box	FİYAT Price
RCV0802	123 mm	1 / 24 adet	



ÇELİK HARF SETİ

- Harf çapı 5 mm.
- Çelik sertliği 58-68 HRC

KOD NO Code No	İÇERİK Detalis	PAKET/KOLİ Package/Box	FİYAT Price
RCH5000	27 pcs	1 / 10 adet	



ÇELİK RAKAM SETİ

- Rakam çapı 5 mm.
- Çelik sertliği 58-68 HRC

KOD NO Code No	İÇERİK Detalis	PAKET/KOLİ Package/Box	FİYAT Price
RCH0190	9 pcs	1 / 10 adet	



ÇELİK TEL FIRÇA

- 4x16 sıra karbon çeliğinden tel.
- Ergonomik yumuşak çift malzemeden sap.

KOD NO Code No	ÖLÇÜ mm	PAKET/KOLİ Package/Box	FİYAT Price
RTF0086	260 mm	6 / 36 adet	



ÇELİK TEL FIRÇA - RENDE TİPİ

- 5x32 sıra karbon çeliğinden tel.
- Ergonomik yumuşak çift malzemeden sap.

KOD NO Code No	ÖLÇÜ mm	PAKET/KOLİ Package/Box	FİYAT Price
RTF0053	240 mm	6 / 36 adet	



500
LUMEN



ŞARJLI LED ÇALIŞMA LAMBASI

- 230 volt gerilimde çalışma.
- 60.000 saat led ömrü.
- Askı ve mıknatıs özelliği.
- USB Şarj kablosu

KOD NO Code No	ÖLÇÜ mm	PAKET/KOLİ Package/Box	FİYAT Price
RCL0570	3 Watt COB Led	1 / 10 adet	

330
LUMEN



Üst LED

ŞARJLI LED ÇALIŞMA LAMBASI

- 230 volt gerilimde çalışma.
- 60.000 saat led ömrü.
- Askı ve mıknatıs özelliği.
- USB Şarj kablosu

KOD NO Code No	ÖLÇÜ mm	PAKET/KOLİ Package/Box	FİYAT Price
RCL0470	6 Adet SMD Led	1 / 10 adet	

200
LUMEN



ŞARJLI LED ÇALIŞMA LAMBASI

- 230 volt gerilimde çalışma.
- 60.000 saat led ömrü.
- Askı ve mıknatıs özelliği.
- Cep telefonu şarjı için power bank özelliği
- USB Şarj kablosu

KOD NO Code No	ÖLÇÜ mm	PAKET/KOLİ Package/Box	FİYAT Price
RCL0200	4 Adet SMD Led	1 / 20 adet	

KALEM TİPİ EL FENERİ

- 3xAAA pil
- Uçak alüminyum gövde

KOD NO Code No	ÖLÇÜ mm	PAKET/KOLİ Package/Box	FIYAT Price
RCL0013	CREE XPG2 S2 LED	1 / 10 adet	



SEYYAR LED ÇALIŞMA LAMBASI

- 230 volt gerilimde çalışma.
- 60.000 saat led ömrü.

KOD NO Code No	ÖLÇÜ mm	PAKET/KOLİ Package/Box	FIYAT Price
RCL0160	6 adet Led	1 / 10 adet	



SEYYAR LED ÇALIŞMA LAMBASI

- 230 volt gerilimde çalışma.
- 60.000 saat led ömrü.
- Askı özelliği.

KOD NO Code No	ÖLÇÜ mm	PAKET/KOLİ Package/Box	FIYAT Price
RCL0170	3 Watt COB Led	1 / 10 adet	

ŞARJLI



KAFA DERECELİ

- 3xAAA pil
- 2m'ye kadar IPx8 su geçirmezlik özelliği
- Uçak alüminyum gövde

KOD NO Code No	ÖLÇÜ mm	PAKET/KOLİ Package/Box	FIYAT Price
RCL0020	CREE XPG2 S2 LED	1 / 10 adet	





RAYLI ÇEKTİRME

- Tekerlek, disk ve rulmanların sökölüp takılmasında kullanılır.
- Chrome vanadium çeliğinden imal edilmiş çeneler sıcak dövmedir.

KOD NO Code No	ÖLÇÜ mm	PAKET/KOLİ Package/Box	FİYAT Price
RRC1210	120 x 100 mm	1 / 20 adet	



RAYLI ÇEKTİRME

- Tekerlek, disk ve rulmanların sökölüp takılmasında kullanılır.
- Chrome vanadium çeliğinden imal edilmiş çeneler sıcak dövmedir.

KOD NO Code No	ÖLÇÜ mm	PAKET/KOLİ Package/Box	FİYAT Price
RRC3075	65 x 70 mm	1 / 60 adet	
RRC4100	70 x 100 mm	1 / 24 adet	
RRC5125	100 x 100 mm	1 / 24 adet	
RRC7175	140 x 150 mm	1 / 8 adet	
RRC9225	190 x 150 mm	1 / 8 adet	



ÇELİK DÖVME MENGENE

- Yanlardaki zaviye somunları sayesinde çenelerin paralelliği ve kızakların yataklaması gerektiğinde kolayca ayarlanabilir.
- Çeneler üzerindeki derin diş yapıları sayesinde ürünleri daha sıkı bir şekilde kavrama özelliğine sahiptir.
- Yüksek kalite çelikten dövme yöntemi kullanılarak imal edilmiştir.
- Komple sulama (sertleştirme) yapıldığı gibi çeneler ve örs kısımları ayrıca indüksiyonla sertleştirilmiştir.

KOD NO Code No	ÖLÇÜ mm	PAKET/KOLİ Package/Box	FİYAT Price
RMT0100	100 mm	1 adet	
RMT0125	125 mm	1 adet	



EKO MENGENE

- Yanlardaki zaviye somunları sayesinde çenelerin paralelliği ve kızakların yataklaması gerektiğinde kolayca ayarlanabilir.
- Çeneler üzerindeki derin diş yapıları sayesinde ürünleri daha sıkı bir şekilde kavrama özelliğine sahiptir.
- Komple sulama (sertleştirme) yapıldığı gibi çeneler ve örs kısımları ayrıca indüksiyonla sertleştirilmiştir.

KOD NO Code No	ÖLÇÜ mm	PAKET/KOLİ Package/Box	FİYAT Price
RDM0075	75 mm	1 adet	
RDM0100	100 mm	1 adet	
RDM0125	125 mm	1 adet	

EKO MENGENE DÖNER TABLA

KOD NO Code No	ÖLÇÜ mm	PAKET/KOLİ Package/Box	FİYAT Price
RDM1075	75 mm	1 adet	
RDM1100	100 mm	1 adet	
RDM1150	150 mm	1 adet	
RDM1200	200 mm	1 adet	



HAVALI ALETLER

Güç ve Hassasiyet

- ◆ Yüksek tork değerlerine sahip somun sökme makinaları hızlı ve sessiz olarak tasarlanmıştır.
- ◆ Hobi kullanımdan, zorlu koşullar altında, sanayinin aradığı en üst kalite değerlerine uygundur.
- ◆ Sürekli yedekparça politikamız tüm Retta Havalı Aletler için hızlı servis çözümleri sunar.

Ergonomi ve Geniş Ürün Gami

- ◆ Ergonomiktir ve yorulmadan çalışmayı sağlar.
- ◆ Ürün gövdeleri yapılacak iş ve zorluk kullanım koşulları esas alınarak dizayn edilmiştir.
- ◆ Her iş için farklı özellikte tasarlanan geniş ürün gamı.





Mini Gövde

MAX
TORQUE

KOMPOZİT HAVALI SOMUN SÖKME - 1/2"

- Ergonomik yapısı ile tutuş kolaylığı sağlar.
- Kompozit maddeden yapılmış sağlam gövde.

KOD NO Code No	AĞIRLIK Weight	PAKET/KOLİ Package/Box	FIYAT Price
RHS0610	1400 gr	1 / 10 adet	

MODEL	Saket Kareşi Inch	Civata Çapı mm	Max. Tork FT-LB (Nm)	Bosla Devir R.P.M	Hava Tüketimi CFM (l/min)	Çalışma Basıncı PSI (kg/cm ²)	Uzunluk Inch (mm)	Ağırlık LBS (kg)	Ses Şiddeti EN ISO 15744 dBA
RHS0610	1/2" (12.7 mm)	19 mm	450 (610 Nm)	9000	5.7 (161)	90 (6.3)	4.6 (118)	2.4 (1.1)	90

MAX
TORQUE

KOMPOZİT HAVALI SOMUN SÖKME - 1/2"

- Ergonomik yapısı ile tutuş kolaylığı sağlar.
- Kompozit maddeden yapılmış sağlam gövde.

KOD NO Code No	AĞIRLIK Weight	PAKET/KOLİ Package/Box	FIYAT Price
RHS1750	2299 gr	1 / 10 adet	

MODEL	Saket Kareşi Inch	Civata Çapı mm	Max. Tork FT-LB (Nm)	Bosla Devir R.P.M	Hava Tüketimi CFM (l/min)	Çalışma Basıncı PSI (kg/cm ²)	Uzunluk Inch (mm)	Ağırlık LBS (kg)	Ses Şiddeti EN ISO 15744 dBA
RHS1750	1/2" (12.7 mm)	19 mm	1290 (1750 Nm)	7500	5.7 (161)	90 (6.3)	7.7 (196)	4.6 (2.1)	90

MAX
TORQUE

KOMPOZİT HAVALI SOMUN SÖKME - 3/4"

- Ergonomik yapısı ile tutuş kolaylığı sağlar.
- Kompozit maddeden yapılmış sağlam gövde.

KOD NO Code No	AĞIRLIK Weight	PAKET/KOLİ Package/Box	FIYAT Price
RHS2100	4019 gr	1 / 3 adet	

MODEL	Saket Kareşi Inch	Civata Çapı mm	Max. Tork FT-LB (Nm)	Bosla Devir R.P.M	Hava Tüketimi CFM (l/min)	Çalışma Basıncı PSI (kg/cm ²)	Uzunluk Inch (mm)	Ağırlık LBS (kg)	Ses Şiddeti EN ISO 15744 dBA
RHS2100	3/4" (19 mm)	1-1/4" (32 mm)	1550 (2100 Nm)	5000	7.8 (221)	90 (6.3)	9.3 (235)	8.1 (3.7)	90



1/2 HAVALI SOMUN SÖKME

- Sağlam ve hafif kompozit gövde
- İkiç çekme mekanizması
- Güç ayarlayıcı düğme
- Otomobil tamir servislerinde kullanıma uygun

KOD NO Code No	AĞIRLIK Weight	PAKET/KOLİ Package/Box	FIYAT Price
RHS0900	4019 gr	1 / 3 adet	

MODEL	Saket Kareşi Inch	Civata Çapı mm	Max. Tork FT-LB (Nm)	Bosla Devir R.P.M	Hava Tüketimi CFM (l/min)	Çalışma Basıncı PSI (kg/cm ²)	Uzunluk Inch (mm)	Ağırlık LBS (kg)	Ses Şiddeti EN ISO 15744 dBA
RHS0900	1/2" (12.7 mm)	19 mm	640 (900 Nm)	9000	5.7 (161)	90 (6.3)	4.6 (118)	2.5 (1.2)	90

1/2 HAVALI MİNİ SOMUN SÖKME

- Sağlam ve hafif alüminyum gövde
- Jumbo çekiç mekanizması
- Güç ayarlayıcı düğme
- Otomobil tamir servislerinde kullanıma uygun

KOD NO Code No	AĞIRLIK Weight	PAKET/KOLİ Package/Box	FİYAT Price
RHS0600	3657 gr	1 / 10 adet	

MODEL	Soket Karesi Inch	Civata Çapı mm	Max. Tork FT-LB (Nm)	Boşta Devir R.P.M	Hava Tüketimi CFM (l/min)	Çalışma Basıncı PSI (kg/cm ²)	Uzunluk Inch (mm)	Ağırlık LBS (kg)	Ses Şiddeti EN ISO 12744 dB(A)
RHS0600	1/2" (12,7 mm)	19 mm	450 (610 Nm)	9000	5,7 (161)	90 (6,3)	4,6 (118)	2,4 (1,1)	90



HAVALI SOMUN SÖKME - 1/2"

- Ergonomik yapısı ile tutuş kolaylığı sağlar.
- Tüm otomotiv, hafif amaçlı kamyon tamiratlarında, onarım işleri için kullanılır.

KOD NO Code No	AĞIRLIK Weight	PAKET/KOLİ Package/Box	FİYAT Price
RFD2600	3657 gr	1 / 10 adet	

MODEL	Soket Karesi Inch	Civata Çapı mm	Max. Tork FT-LB (Nm)	Boşta Devir R.P.M	Hava Tüketimi CFM (l/min)	Çalışma Basıncı PSI (kg/cm ²)	Uzunluk Inch (mm)	Ağırlık LBS (kg)	Ses Şiddeti EN ISO 12744 dB(A)
RFD2600	1/2" (12,7 mm)	19 mm	501 (680 Nm)	7500	8 (225)	90 (6,3)	7,5 (190)	5,7 (2,6)	90



HAVALI SOMUN SÖKME - 3/4"

- Ergonomik yapısı ile tutuş kolaylığı sağlar.
- Kamyon, otobüs, dizel motor, tarım makinaları, arazi araçları ve benzeri onarım işleri için kullanılır.

KOD NO Code No	AĞIRLIK Weight	PAKET/KOLİ Package/Box	FİYAT Price
RFD4600	6345 gr	1 / 3 adet	

MODEL	Soket Karesi Inch	Civata Çapı mm	Max. Tork FT-LB (Nm)	Boşta Devir R.P.M	Hava Tüketimi CFM (l/min)	Çalışma Basıncı PSI (kg/cm ²)	Uzunluk Inch (mm)	Ağırlık LBS (kg)	Ses Şiddeti EN ISO 12744 dB(A)
RFD4600	3/4" (19 mm)	32 mm	885 (1220 Nm)	4500	12 (340)	90 (6,3)	9,5 (240)	10,5 (4,8)	90



Lokma İçeriği: 27, 32 mm

HAVALI SOMUN SÖKME - 1"

- Ergonomik yapısı ile tutuş kolaylığı sağlar.
- Kamyon, otobüs, dizel motor, tarım makinaları, arazi araçları ve benzeri onarım işleri için kullanılır.

KOD NO Code No	AĞIRLIK Weight	PAKET/KOLİ Package/Box	FİYAT Price
RFD5250	9879 gr	1 / 3 adet	

MODEL	Soket Karesi Inch	Civata Çapı mm	Max. Tork FT-LB (Nm)	Boşta Devir R.P.M	Hava Tüketimi CFM (l/min)	Çalışma Basıncı PSI (kg/cm ²)	Uzunluk Inch (mm)	Ağırlık LBS (kg)	Ses Şiddeti EN ISO 12744 dB(A)
RFD5250	1" (25,4 mm)	32 mm	1395 (2000 Nm)	4500	12 (340)	90 (6,3)	9,3 (235)	15,3 (8)	93



Lokma İçeriği: 27, 32 mm



KOMPOZIT HAVALI SOMUN SÖKME - 1"

- Ergonomik yapısı ile tutuş kolaylığı sağlar.
- Kompozit maddeden yapılmış sağlam gövde.
- Kamyon, otobüs, dizel motor, tarım makinaları, arazi araçları ve benzeri onarım işleri için kullanılır.

KOD NO Code No	AĞIRLIK Weight	PAKET/KOLİ Package/Box	FIYAT Price
RHS2445	8407 gr	1 / 3 adet	



KOMPOZIT HAVALI SOMUN SÖKME - 1"

- Ergonomik yapısı ile tutuş kolaylığı sağlar.
- Kompozit maddeden yapılmış sağlam gövde.
- Kamyon, otobüs, dizel motor, tarım makinaları, arazi araçları ve benzeri onarım işleri için kullanılır.

KOD NO Code No	AĞIRLIK Weight	PAKET/KOLİ Package/Box	FIYAT Price
RHS3050	12927 gr	1 / 3 adet	



HAVALI SOMUN SÖKME - 1"

- Ergonomik yapısı ile tutuş kolaylığı sağlar.
- Tüm otomotiv, hafif amaçlı kamyon tamiratlarında, onarım işleri için kullanılır.

KOD NO Code No	AĞIRLIK Weight	PAKET/KOLİ Package/Box	FIYAT Price
RFD5301	14524 gr	1 / 3 adet	

MODEL	Soket Karesi	Max. Tork	Bosta Devir	Hava Tüketimi	Çalışma Basıncı	Uzunluk	Ağırlık	Ses Şiddeti
	inch	FT-LB (Nm)	R.P.M	CFM (l/min)	PSI (kg/cm ²)	inch (mm)	LBS (kg)	EN ISO 15744 dBA
RHS2445	1" (25.4 mm)	1800 (2445 Nm)	4000	14.5 (410)	90 (6.3)	9.9 (251)	15.8 (7.2)	95
RHS3050	1" (25.4 mm)	2250 (3050 Nm)	4500	12 (340)	90 (6.3)	19.8 (503)	24 (10.9)	95
RFD5301	1" (25.4 mm)	1693 (2300 Nm)	4000	23 (650)	90 (6.3)	23.7 (600)	30 (13.5)	95

HAVALI CIRCİR

- Ergonomik yapısı ile tutuş kolaylığı sağlar.
- Küçük çaplı motor, buji, devirdaim pompası, radyatör ve benzeri onarım işleri için kullanılır.

KOD NO Code No	AĞIRLIK Weight	PAKET/KOLİ Package/Box	FİYAT Price
RHC0068	1324 gr	1 / 20 adet	



HAVALI CIRCİR

- Küçük çaplı motor, buji, devirdaim pompası, radyatör ve benzeri onarım işleri için kullanılır.

KOD NO Code No	AĞIRLIK Weight	PAKET/KOLİ Package/Box	FİYAT Price
RHC1000	1275 gr	1 / 20 adet	



























HAVALI TORNAVİDA

- Sağ ve sol devir yönlü.
- Kolay uç değişimi.
- Fabrika üretim bantlarında, atölyelerde, oto tamithanelerinde, kapı pencere üretiminde kullanılır.

KOD NO Code No	AĞIRLIK Weight	PAKET/KOLİ Package/Box	FİYAT Price
RHT0003	874 gr	1 / 3 adet	



MODEL	Soket Kareşi	Civata Çapı	Max. Tork	Boşta Devir	Hava Tüketimi	Çalışma Basıncı	Uzunluk	Ağırlık	Ses Şiddeti
	inch	inch	FT-LB (Nm)	R.P.M	CFM (l/min)	PSI (kg/cm ²)	inch (mm)	LBS (kg)	EN ISO 15744 dBA
RHC0068	 1/2" (12.7 mm)	 1/2" (12.7 mm)	 50 (68 Nm)	 160	 8.5 (240)	 90 (6.3)	 10.55 (268)	 2.5 (1.14)	 93
RHC1000	 1/2" (12.7 mm)	 1/2" (12.7 mm)	 50 (68 Nm)	 160	 8.5 (240)	 90 (6.3)	 10.40 (265)	 2.6 (1.18)	 82
RHT0003			 2.2 (3 Nm)	 1700	 5 (141)	 90 (6.3)	 9.25 (235)	 1.34 (0.6)	 80



KISA GÖVDE

HAVALI TORNAVİDA

- Ergonomik yapısı ile tutuş kolaylığı sağlar.

KOD NO Code No	AĞIRLIK Weight	PAKET/KOLİ Package/Box	FİYAT Price
RHT0013	1334gr	1 /10 adet	



UZUN GÖVDE

HAVALI TORNAVİDA

- Ergonomik yapısı ile tutuş kolaylığı sağlar.

KOD NO Code No	AĞIRLIK Weight	PAKET/KOLİ Package/Box	FİYAT Price
RHT0014	1472gr	1 /10 adet	



KISA GÖVDE

KOMPOZİT HAVALI TORNAVİDA

- Kompozit maddeden yapılmış sağlam gövde.

KOD NO Code No	AĞIRLIK Weight	PAKET/KOLİ Package/Box	FİYAT Price
RHT0015	1323gr	1 /10 adet	



UZUN GÖVDE

KOMPOZİT HAVALI TORNAVİDA

- Kompozit maddeden yapılmış sağlam gövde.

KOD NO Code No	AĞIRLIK Weight	PAKET/KOLİ Package/Box	FİYAT Price
RHT0016	1476gr	1 /10 adet	

MODEL	Soket Kareşi inch	Max. Tork FT-LB (Nm)	Boşta Devir R.P.M	Hava Tüketimi CFM (l/min)	Vidalama Kapasitesi Metrik	Çalışma Basıncı PSI (kg/cm ²)	Uzunluk inch (mm)	Ağırlık LBS (kg)	Ses Şiddeti EN ISO 15744 dBA
RHT0013	1/4" (6 mm)	115 (13 Nm)	1800	4 (113)	M6-M8	90 (6.3)	7 (178)	3.5 (1.13)	87
RHT0014	1/4" (6 mm)	145 (16 Nm)	800	4 (113)	M6-M8	90 (6.3)	8.5 (216)	2.67 (1.21)	87
RHT0015	1/4" (6 mm)	115 (13 Nm)	1800	4 (113)	M6-M8	90 (6.3)	7 (178)	2.09 (0.95)	81
RHT0016	1/4" (6 mm)	145 (16 Nm)	800	4 (113)	M6-M8	90 (6.3)	9.3 (235)	2.2 (1)	81



UZUN GÖVDE

KOMPOZİT HAVALI MATKAP - 1/2"

- Kompozit maddeden yapılmış sağlam gövde.

KOD NO Code No	AĞIRLIK Weight	PAKET/KOLİ Package/Box	FİYAT Price
RHM0400	1644gr	1 /10 adet	



KISA GÖVDE

KOMPOZİT HAVALI MATKAP - 3/8"

- Kompozit maddeden yapılmış sağlam gövde.

KOD NO Code No	AĞIRLIK Weight	PAKET/KOLİ Package/Box	FİYAT Price
RHM1800	1265gr	1 /10 adet	

MODEL	Soket Kareşi	Hava Girişi	Hortum Çapı	Boşta Devir	Hava Tüketimi	Çalışma Basıncı	Uzunluk	Ağırlık	Ses Şiddeti
	inch	inch	inch	R.P.M	CFM (l/min)	PSI (kg/cm ²)	inch (mm)	LBS (kg)	EN ISO 15744 dBA
RHM0400	1/2" (12.7 mm)	1/4"	3/8"	400	8.5 (240)	90 (6.3)	8.75 (207)	2.87 (1.3)	81
RHM1800	3/8" (9.52 mm)	1/4"	3/8"	1800	8.5 (240)	90 (6.3)	6.85 (174)	2.2 (1)	81

HAVALI KALIPÇI TAŞLAMA

- Kompozit maddeden yapılmış sağlam gövde.

KOD NO Code No	AĞIRLIK Weight	PAKET/KOLİ Package/Box	FİYAT Price
RHK2500	530gr	1 /10 adet	



MODEL	Soket Kareşi	Pens Çapı	Boşta Devir	Hava Tüketimi	Çalışma Basıncı	Uzunluk	Ağırlık	Ses Şiddeti
	inch	(mm)	R.P.M	CFM (l/min)	PSI (kg/cm ²)	inch (mm)	LBS (kg)	EN ISO 15744 dBA
RHK2500	1/4" (6 mm)	6	25000	10.6 (300)	90 (6.3)	6 (153)	0.8 (0.36)	86



KALAFAT ÇEKİCİ

- Kaporta tamir bakım işlerinde kullanılır.
- Düşük vibrasyon.
- Konforlu plastik tutamak.

KOD NO Code No	ÖLÇÜ mm	AĞIRLIK Weight	PAKET/KOLİ Package/Box	FİYAT Price
RHC3500	3/4"	1700gr	1 / 10 adet	



HAVALI ZIMPARA

- Otomotiv, mobilya sektöründe yüzeyleri temizleme ve düzeltme işleri için kullanılır.

KOD NO Code No	ÖLÇÜ mm	AĞIRLIK Weight	PAKET/KOLİ Package/Box	FİYAT Price
RHZ3004	Ø 150 mm	1563gr	1 / 10 adet	



HAVALI ZIMPARA YEDEK PADLER

- Otomotiv, mobilya sektöründe yüzeyleri temizleme ve düzeltme işleri için kullanılır.

KOD NO Code No	ÖLÇÜ mm	AĞIRLIK Weight	PAKET/KOLİ Package/Box	FİYAT Price
RZP0150	150 mm	135gr	6 / 120 adet	

MODEL	Orbital Çap inch(mm)	Hava Girişi inch	Boşta Devir R.P.M	Hava Tüketimi CFM (l/min)	Çalışma Basıncı PSI (kg/cm ²)	Ağırlık LBS (kg)	Ses Şiddeti EN ISO 15744 dBA
RHZ3004	3/16" (5 mm)	1/4"	10.000	8 (226)	90 (6.3)	2.2 (1)	73

HAVALI GRES TABANCASI

- Ergonomik yapısı ile tutuş kolaylığı sağlar.

KOD NO Code No	ÖLÇÜ mm	AĞIRLIK Weight	PAKET/KOLİ Package/Box	FIYAT Price
RHG4000	450 cc	1587gr	1 / 10 adet	

KARTUŞ KAPASİTESİ	GİRİŞ BASINCI	ÇIKIŞ BASINCI	AĞIRLIK
14 oz.	40 - 150 P.S.I.	1600-6000 P.S.I.	1.6 Kg.



HAVALI PERÇİN

- Ergonomik yapısı ile tutuş kolaylığı sağlar.

KOD NO Code No	ÖLÇÜ mm	AĞIRLIK Weight	PAKET/KOLİ Package/Box	FIYAT Price
RHP2448	1/2"	1752gr	1 / 10 adet	

ÇALIŞMA KAPASİTESİ	ÇEKME KAPASİTESİ	STROK	ÇALIŞMA BASINCI	YÜKSEKLİK	PERÇİN ÇAPI
up to 3/16	870 kg	14 mm	85-100 PSI	273 mm	2.4-3.2-4-4.8 mm Alü





8 F SERİSİ

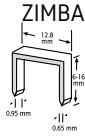

Zimba Özellikleri: Çene genişliği 12.8 mm

HAVALI ZIMBA MAKİNASI

- Koltuk kaplama, dolap montajı ve mobilya üretiminde kullanılır.
- Hafif ve güçlü yapı.
- Pres döküm, alüminyum gövde.
- Yekpare dil.
- Kolay açılabilen hazne.
- Konforlu plastik tutamak.

KOD NO Code No	ÖLÇÜ mm	PAKET/KOLİ Package/Box	FİYAT Price
RHZ8016	12.8 mm	1 / 10 adet	

F SERİSİ
ÇİVİ

Çivi Özellikleri: Tel genişliği 1.00-1.25 mm,
Uzunluk 10-32 mm

HAVALI ÇİVİ MAKİNASI

- Dolap ve çekmece imalatı, resim çerçeveleri, dekoratif mobilya tamiratında kullanılır.
- Uzun süreli kullanım için sertleştirilmiş çelik karışım yapıtlı dil.
- 360° ayarlanabilir egzoz deflektörü.
- Ayarlanabilir derinlik basınç özelliği.
- Pres döküm, alüminyum gövde.

KOD NO Code No	ÖLÇÜ mm	PAKET/KOLİ Package/Box	FİYAT Price
RHC1832	10-32 mm	1 / 10 adet	



ŞARTLANDIRICI - TEK

- Kompresörden çıkan havayı filtre eder.

KOD NO Code No	ÖLÇÜ mm	PAKET/KOLİ Package/Box	FİYAT Price
RHS1201	1/2"	1 / 5 adet	

HAVA GİRİŞİ	ÇALIŞMA ISISI	SU KAPASİTESİ	YAĞ KAPASİTESİ	MAX.GİRİŞ BASINCI	MAX. ÇIKIŞ BASINCI
1/2 "	5-60 °C	80 ml	125 ml	215 PSI	7-150 PSI

POLIÜRETAN HAVA HORTUMU

- Basınca dayanıklı poliüretan spiral hava hortumu.



KOD NO Code No	ÖLÇÜ mm	PAKET/KOLİ Package/Box	FİYAT Price
RHH5875	5x8 / 7.5 m	1 / 5 adet	
RHH5815	5x8 / 15 m	1 / 5 adet	
RHH8175	8x12 / 7.5 m	1 / 5 adet	
RHH8115	8x12 / 15 m	1 / 5 adet	

MAKARALI HORTUM

- Oto ve hafif ticari araçlara hizmet veren servislerde kullanılır.
- Galvaniz malzemeden üretilmiş duvara monte ayaklar.
- Tamamen suya ve neme dayanıklı gövde.
- Yaylı mekanizma sayesinde kolay toplanabilme özelliği.



8x12 mm

KOD NO Code No	ÖLÇÜ mm	PAKET/KOLİ Package/Box	FİYAT Price
RHH1500	16 metre	1 / 5 adet	





HORTUM UÇLU REKORLAR

- Çalışma basıncı 1-16 bar

KOD NO Code No	ÖLÇÜ mm	PAKET/KOLİ Package/Box	FİYAT Price
RHS0030	9 mm	10 / 120	
RHS0040	11 mm	10 / 120	



DİŞİ UÇLU REKOR

- Çalışma basıncı 1-16 bar

KOD NO Code No	ÖLÇÜ mm	PAKET/KOLİ Package/Box	FİYAT Price
RDS0010	1/4"	10 / 120	



ERKEK UÇLU REKORLAR

- Çalışma basıncı 1-16 bar

KOD NO Code No	ÖLÇÜ mm	PAKET/KOLİ Package/Box	FİYAT Price
RES0010	1/4"	10 / 120	
RES0030	1/2"	10 / 120	

REKOR DİŞİ UÇLAR

- Çalışma basıncı 1-16 bar

KOD NO Code No	ÖLÇÜ mm	PAKET/KOLİ Package/Box	FIYAT Price
RDU0010	1/4"	12 / 120	
RDU0020	3/8"	12 / 120	
RDU0030	1/2"	12 / 120	



REKOR ERKEK UÇLAR

- Çalışma basıncı 1-16 bar

KOD NO Code No	ÖLÇÜ mm	PAKET/KOLİ Package/Box	FIYAT Price
REU0010	1/4"	12 / 120	
REU0020	3/8"	12 / 120	
REU0030	1/2"	12 / 120	



REKOR HORTUM UÇLAR

- Çalışma basıncı 1-16 bar

KOD NO Code No	ÖLÇÜ mm	PAKET/KOLİ Package/Box	FIYAT Price
RHU0030	11 mm	12 / 120	



KONİK REKOR UÇ (ERKEK)

- Çalışma basıncı 1-16 bar

KOD NO Code No	ÖLÇÜ mm	PAKET/KOLİ Package/Box	FIYAT Price
RSU0020	10 mm	12 / 120	



BAHÇE ALETLERİ



Güç ve Hassasiyet

- ◆ Bükülmeye ve kırılmaya karşı yüksek dayanıklılığa sahip özel japon bıçak çeliğinden üretilmiştir.
- ◆ Hobi kullanımdan, zorlu koşullar altında, tarım sanayinin aradığı en üst kalite değerlerine uygundur.
- ◆ Kesici ağzlar, özel olarak sertleştirilmiş ve ileri teknoloji ile bilenmiştir.

Ergonomi ve Geniş Ürün Gami

- ◆ İki bileşenli yüksek kaliteli saplar kaymaya karşı koruyuculuğu olup ergonomiktir ve yorulmadan çalışmayı sağlar.
- ◆ Keskin kenarları sıkıntısız 0'a indirilmiş ergonomik gövde tasarımı.



DAL BUDAMA TESTERESİ

- 52 HRC ağız ve 60 HRC'ye kadar sertleştirilmiş dişler.
- Sürtünmeyi en aza indiren pürüzsüz yüzey.
- Yumuşak çift plastikli sap.
- Özel diş yapısı.
- Mat krom kaplamalı yüzey.

KOD NO Code No	ÖLÇÜ mm	PAKET/KOLİ Package/Box	FIYAT Price
RBT0330	330 mm	10 /60 adet	



BAĞ MAKASI

- İndüksiyonla sertleştirilmiş hassas ve kesici ağızlar.
- Sıcak dövülmüş ve hassas sertleştirilmiş özel alet çeliği.
- Entegre yaylar sayesinde kolay kullanım.

KOD NO Code No	ÖLÇÜ mm	PAKET/KOLİ Package/Box	FIYAT Price
RBM1030	225 mm	10 / 60 adet	



BAĞ MAKASI

- İndüksiyonla sertleştirilmiş hassas ve kesici ağızlar.
- Sıcak dövülmüş ve hassas sertleştirilmiş özel alet çeliği.
- Entegre yaylar sayesinde kolay kullanım.

KOD NO Code No	ÖLÇÜ mm	PAKET/KOLİ Package/Box	FIYAT Price
RBM1036	225 mm	10 / 60 adet	



BAĞ MAKASI



- İndüksiyonla sertleştirilmiş hassas ve kesici ağızlar.
- Sıcak dövülmüş ve hassas sertleştirilmiş özel alet çeliği.
- Entegre yaylar sayesinde kolay kullanım.

KOD NO Code No	ÖLÇÜ mm	PAKET/KOLİ Package/Box	FIYAT Price
RBM1032	225 mm	10 / 60 adet	

ÇİVATALARDA AĞIZ ÖLÇÜLERİ ÖNERİLEN TABLOSU (BAĞLAYICI OLMAYAN)

+	DIN 267 sıkma değerleri NM CİNSİNDEN					
	4.65	.6	6.98	.8	10.9	12.9
M 2,5	0,284	0,373	0,726	0,863	1,206	1,451
M 3	0,441	0,588	1,128	1,344	1,883	2,256
M 3,5	0,677	0,902	1,736	2,060	2,893	3,481
M 4	1,000	1,344	2,599	3,040	4,315	5,148
M 5	1,916	2,648	5,099	6,031	8,483	10,200
M 6	3,432	4,511	8,728	10,300	14,710	17,652
M 7	5,590	7,453	14,220	17,162	24,517	28,439
M 8	8,238	10,787	21,575	25,497	35,304	42,168
M 10	16,67	21,575	42,168	50,014	70,608	85,317
M 12	28,44	38,246	73,550	87,279	122,60	147,10
M 14	45,11	60,801	116,70	138,30	194,20	235,40
M 16	69,63	93,163	178,5	210,80	299,10	357,90
M 18	95,12	127,50	245,20	289,3	411,90	490,30
M 20	135,3	180,45	384,10	411,90	578,60	696,30
M 22	182,4	245,16	470,70	559,00	784,50	941,40
M 24	230,5	308,91	598,20	711,00	1000	1196
M 27	343,2	460,90	887,50	1049	1481	1775
M 30	465,8	622,72	1206	1422	2010	2403
M 33	632,5	848,30	1628	1932	2716	3266
M 36	814,0	1089	2099	2481	3491	4197
M 39	1059	1412	2716	3226	4531	5443
M 42	1304	1746	3364	3991	5609	6727
M 45	1638	2177	4207	4992	7012	8414
M 48	1981	2638	5080	6021	8473	10150
M 52	2540	3393	6541	7747	10885	13092
M 56	3168	4227	8149	9650	13582	16279
M 60	3932	5247	10101	11964	16867	20202
M 64	4737	6306	12160	14416	20300	24320

**ANAHTARLAR İÇİN
MIN. DÖNDÜRME MOMENTLERİ**

mm			
5	11,53	3,55	
5,5	14,44	4,64	
6*	17,65	5,92	7,4
7	25,29	9,12	11,4
8	34,5	13,3	16,6
9*	45,4	18,4	23
10	58,1	24,8	31
11	72,7	32,3	40,4
12*	89,1	41,2	51,5
13	107	51,6	64,5
14*	128	63,5	79,4
15	150	77,0	96,2
16	175	92,3	115
17*	201	107	134
18	230	128	160
19*	261	149	186
20*	294	172	215
21	330	198	247
22*	368	225	281
23*	408	255	319
24	451	287	359
25*	496	322	402
26*	544	359	449
27	594	399	499
28*	647	442	552
30	760	536	670
32*	884	643	804
34	1019	761	951
36	1165	894	1117
41	1579	1154	1442
46	2067	1453	1816
50	2512	1716	2145
55	3140	2077	
60	3849	2471	
65	4021	2900	
70	4658	3364	
75	5394	3862	
80	6178	4394	
85	6963		
90	7845		
95	8336		

* DIN ISO 272 stanlarında yer almaz

Ürün Kodu	Fiyat \$	Sayfa No	Ürün Kodu	Fiyat \$	Sayfa No	Ürün Kodu	Fiyat \$	Sayfa No	Ürün Kodu	Fiyat \$	Sayfa No
RAA0607		36	RAK3050		192	RAP0510		100	RBA1450		142
RAA0809		36	RAK3100		193	RAP3000		100	RBA2503		134
RAA1011		36	RAK3150		192	RAP4000		100	RBA2505		134
RAA1213		36	RAL0M10		187	RAP5100		100	RBA2506		134
RAA1415		36	RAL0T50		187	RAP6100		100	RBA3004		140
RAA1617		36	RAL1004		72	RAS0130		187	RBA3005		140
RAA1819		36	RAL1005		72	RAS0619		88	RBA3006		140
RAA2022		36	RAL1006		72	RAS3001		194	RBA3008		140
RAA2123		36	RAL1007		72	RAS6001		194	RBA3010		140
RAA2427		36	RAL1008		72	RAT0908		48	RBA3012		140
RAA2528		36	RAL1009		72	RAT0913		49	RBA3233		185
RAA3032		36	RAL1010		72	RAT3009		47	RBA3809		63-187
RAA4146		36	RAL1012		72	RAT4009		47	RBA3825		63-187
RAA6722		36	RAL1014		72	RAT5009		47	RBA3850		142
RAA6732		36	RAL1017		72	RAT6009		48	RBA5003		136
RAB0003		148	RAL1019		72	RAT7009		49	RBA5004		136
RAB0005		148	RAL1234		70	RAT8009		48	RBA5005		136
RAB0006		148	RAL1238		70	RAT9009		49	RBA5006		136
RAB0011		148	RAL1438		58	RAU0025		137	RBA7504		140
RAB0901		179	RAL3410		84	RAY1012		42	RBA7505		140
RAB0906		179	RAL3412		84	RAY1113		42	RBA7506		140
RAB1723		182	RAL3414		84	RAY1315		42	RBA7508		140
RAC0001		148	RAL3417		84	RAY1415		42	RBA7510		140
RAC0117		179	RAL3419		84	RAY1922		42	RBA7512		140
RAD4125		124	RAL3422		84	RAY3080		124	RBB0322		157
RAD5125		124	RAL3812		64	RAY4100		124	RBB0330		157
RAD5150		124	RAL3814		64	RAY4125		124	RBB0330B		157
RAD6045		125	RAL5004		72	RAY5100		124	RBB0638		157
RAD6100		124	RAL5005		72	RAY5125		124	RBB0638B		157
RAD6125		124	RAL5006		72	RAY6045		125	RBB1250		157
RAD6200		124	RAL5007		72	RAY6100		124	RBB1250B		157
RAD8150		124	RAL5008		72	RAY8150		124	RBB1410		126
RAH1034		91	RAL5009		72	RAZ6045		125	RBC0622		166
RAH1034R		91	RAL5010		72	RBA0116		70	RBK0003		175
RAH3412		90	RAL5012		72	RBA0121		70	RBK0125		137
RAH3412R		90	RAL5014		72	RBA1200		74	RBK0225		137
RAI0180		134	RAL5017		72	RBA1216		75	RBK0250		108
RAI0316		134	RAL5019		72	RBA1221		75	RBK0280		108
RAI0532		134	RAM1038		153	RBA1250		142	RBK0325		137
RAI0732		134	RAM1312		153	RBA1406		74	RBM0042		156
RAI0964		134	RAM1338		153	RBA1412		142	RBM1030		219
RAK3000		193	RAM1618		153	RBA1425		142	RBM1032		219

Ürün Kodu	Fiyat \$	Sayfa No	Ürün Kodu	Fiyat \$	Sayfa No	Ürün Kodu	Fiyat \$	Sayfa No	Ürün Kodu	Fiyat \$	Sayfa No
RBM1036		219	RBP1140		147	RBT0560		141	RBT5030		136
RBPO250		182	RBP1146		147	RBT0565		141	RBT5040		136
RBP1014		147	RBP1152		147	RBT0575		141	RBT7010		136
RBP1016		147	RBR3005		140	RBT0780		141	RBT7015		136
RBP1017		147	RBR3006		140	RBT0T05		54	RBT7020		136
RBP1019		147	RBR3007		140	RBT0T06		54	RBT7025		136
RBP1020		147	RBR3008		140	RBT0T08		54	RBT7030		136
RBP1022		147	RBR3009		140	RBT0T10		54	RBT7505		139
RBP1025		147	RBR3010		140	RBT0T15		54	RBT7506		139
RBP1028		147	RBR3012		140	RBT0T20		54	RBT7508		139
RBP1029		147	RBR3014		140	RBT1010		134	RBT7510		139
RBP1030		147	RBR3016		140	RBT1015		134	RBT7512		139
RBP1032		147	RBR7505		140	RBT1020		134	RBT7520		139
RBP1035		147	RBR7506		140	RBT1025		134	RBT7525		139
RBP1038		147	RBR7507		140	RBT1027		134	RBT7527		139
RBP1040		147	RBR7508		140	RBT1030		134	RBT7530		139
RBP1041		147	RBR7509		140	RBT1040		134	RBT7540		139
RBP1044		147	RBR7510		140	RBT2010		135	RBT7545		139
RBP1048		147	RBR7512		140	RBT2015		135	RBT7550		139
RBP1051		147	RBR7514		140	RBT2020		135	RBT7555		139
RBP1054		147	RBR7516		140	RBT2025		135	RBT7560		139
RBP1057		147	RBS0015		137	RBT2027		135	RBU0025		134
RBP1065		147	RBS00M4		135	RBT2030		135	RBU0050		136
RBP1068		147	RBS00M5		135	RBT2040		135	RBU0070		136
RBP1070		147	RBS00M6		135	RBT3005		139	RBU0100		136
RBP1073		147	RBS00M8		135	RBT3006		139	RBU0150		136
RBP1076		147	RBS5030		138	RBT3008		139	RBU0250		136
RBP1079		147	RBS5530		138	RBT3010		139	RBU0325		135
RBP1083		147	RBS6030		138	RBT3012		139	RBU0350		137
RBP1086		147	RBT0008		134	RBT3020		139	RBU0425		135
RBP1089		147	RBT0009		134	RBT3025		139	RBU0450		137
RBP1092		147	RBT0010		134	RBT3027		139	RBU1025		134
RBP1095		147	RBT0015		134	RBT3030		139	RBU1050		136
RBP1098		147	RBT0020		134	RBT3040		139	RBU1070		136
RBP1102		147	RBT0025		134	RBT3045		139	RBU1100		136
RBP1105		147	RBT0027		134	RBT3050		139	RBU1150		136
RBP1108		147	RBT0030		134	RBT3055		139	RBU2025		134
RBP1111		147	RBT0040		134	RBT3060		139	RBU2050		136
RBP1114		147	RBT0115		115	RBT5015		136	RBU3025		135
RBP1121		147	RBT0260		141	RBT5020		136	RBU3050		137
RBP1127		147	RBT0275		141	RBT5025		136	RBU3070		136
RBP1133		147	RBT0330		219	RBT5027		136	RBU4050		136

Ürün Kodu	Fiyat \$	Sayfa No	Ürün Kodu	Fiyat \$	Sayfa No	Ürün Kodu	Fiyat \$	Sayfa No	Ürün Kodu	Fiyat \$	Sayfa No
RBY0125		135	RCA0512		41	RCK0209		56	RCZ9016		165
RBY0225		135	RCA0513		41	RCK0306		62	RCZ9022		165
RBY0325		135	RCA0514		41	RCK0309		62	RCZ9028		165
RBY0425		135	RCA0515		41	RCK0310		62	RCZ9035		165
RBY0525		135	RCA0517		41	RCK0406		66	RDA0052		179
RBZ0150		136	RCA0519		41	RCK0409		66	RDB5101		163
RBZ1100		136	RCA0521		41	RCK0410		66	RDK0012		175
RBZ1150		136	RCA0522		41	RCK0509		67	RDK0150		169
RBZ3070		136	RCA0524		41	RCK0609		67	RDK0250		182
RBZ5050		136	RCA0608		41	RCK0709		67	RDK0400		182
RCA0108		39	RCA0610		41	RCK1085		85	RDM0075		204
RCA0109		39	RCA0612		41	RCK3500		82	RDM0100		204
RCA0111		39	RCA0613		41	RCL0013		203	RDM0125		204
RCA0112		39	RCA0614		41	RCL0020		203	RDM1075		204
RCA0113		39	RCA0615		41	RCL0160		203	RDM1100		204
RCA0114		39	RCA0617		41	RCL0170		203	RDM1150		204
RCA0115		39	RCA0619		41	RCL0200		202	RDM1200		204
RCA0116		39	RCA0621		41	RCL0470		202	RDS0010		216
RCA0117		39	RCA0622		41	RCL0570		202	RDS0175		180
RCA0119		39	RCA0624		41	RCM0316		170	RDT0041		130
RCA0122		39	RCA1019		42	RCM0525		170	RDT1516		163
RCA0124		39	RCC0300		170	RCN0038		166	RDT1824		163
RCA0200		52	RCC0500		170	RCR1060		178	RDT1840		163
RCA0208		40	RCC0600		170	RCS0819		40	RDT1924		163
RCA0212		40	RCC1000		170	RCT0020		165	RDT1940		163
RCA0214		40	RCC1500		170	RCT0025		165	RDT2132		163
RCA0215		40	RCF0015		165	RCT0030		165	RDU0010		217
RCA0219		40	RCF0020		165	RCT0032		165	RDU0020		217
RCA0221		40	RCF0025		165	RCT0040		165	RDU0030		217
RCA0222		40	RCF0035		165	RCT0050		165	REB1150		132
RCA0224		40	RCF0040		165	RCT0120		130	REB1225		132
RCA0227		40	RCF0050		165	RCT0180		130	REB1250		132
RCA0230		40	RCG1025		170	RCT0210		52	REB1270		132
RCA0232		40	RCG1030		170	RCT3615		130	REB2225		132
RCA0308		40	RCG1035		170	RCV0802		201	RED3100		127
RCA0312		40	RCG1040		170	RCY0810		39	RED5125		127
RCA0314		40	RCG1050		170	RCY1011		39	RED6150		127
RCA0315		40	RCH0190		201	RCY1213		39	REK0115		186
RCA0317		40	RCH5000		201	RCY1314		39	REK2015		145
RCA0319		40	RCK0109		67	RCY1719		39	REK2620		145
RCA0508		41	RCK0206		56	RCZ9008		165	REK2624		145
RCA0510		41	RCK0207		56	RCZ9013		165	REK2925		145

Ürün Kodu	Fiyat \$	Sayfa No	Ürün Kodu	Fiyat \$	Sayfa No	Ürün Kodu	Fiyat \$	Sayfa No	Ürün Kodu	Fiyat \$	Sayfa No
REK2930		145	RET0060		128	RFB0906		179	RGM1150		161
REK2930K		145	RET0560		128	RFD2600		207	RGP0101		196
REL0012		189	RET0660		128	RFD4600		207	RGS0115		162
REL0013		189	RET0760		128	RFD5250		207	RGS0180		162
REL0014		189	RET0860		128	RFD5301		208	RGS0230		162
REL0015		189	RET0960		128	RFL0645		75	RGT0180		162
REL0017		189	RET1010		133	RFL0745		75	RGT0230		162
REL0019		189	RET1015		133	RFL0845		75	RGT2180		163
REM0005		151	RET1020		133	RFL1045		75	RGT2230		163
REM0104		151	RET1025		133	RFL1145		75	RGU4000		196
REM0105		151	RET1027		133	RFL1245		75	RHA0460		87
REM0106		151	RET1030		133	RFL1345		75	RHA0560		87
REM0107		151	RET1060		128	RFL1445		75	RHA0660		87
REM0108		151	RET1080		128	RFL1745		75	RHA0760		87
REM0112		151	RET1150		128	RFL1945		75	RHA0860		87
REM1338		153	RET1506		128	RFM0600		126	RHA1060		87
REP0013		180	RET2006		128	RFM1600		126	RHA1234		87
REP0033		152	RET2508		128	RFP0250		101	RHA1260		87
RES0010		216	RET3010		128	RFP0300		101	RHA1460		87
RES0030		216	RET3510		128	RFP0400		101	RHA1760		87
RES0101		30	RET5010		133	RFP2180		101	RHA3412		90
RES0102		30	RET5015		133	RFP2250		101	RHB0300		197
RES0105		149	RET5020		133	RFP6090		184	RHC0068		209
RES0111		30	RET5025		133	RFP8515		184	RHC1000		209
RES0121		30	RET5027		133	RFS6073		183	RHC1832		214
RES0201		32	RET5030		133	RFS7385		183	RHC3500		212
RES0221		32	REU0010		217	RFT2706		184	RHD1024		91
RES0261		32	REU0020		217	RFT3206		184	RHD1027		91
RES0291		32	REU0030		217	RFT3606		184	RHD1030		91
RES0301		31	REY0075		127	RFT6000		198	RHD1032		91
RES0311		31	REY1100		127	RFT6514		184	RHD1036		91
RES0321		29	REY2100		127	RFT6606		184	RHD1038		91
RES0341		29	RFA0012		74	RFT7414		184	RHD1041		91
RES0421		31	RFA0014		58	RFT7612		184	RHD1046		91
RES0431		29	RFA0033		200	RFT7614		184	RHD1065		91
RES0451		31	RFA0038		64	RFT8616		184	RHD1200		88
RES0491		31	RFA0039		200	RFY0512		181	RHD1213		86
RES0501		31	RFA0173		183	RFY0515		181	RHD1217		86
RES0502		30	RFA6016		183	RGF0180		162	RHD1218		86
RES0601		33	RFA6110		184	RGK1020		178	RHD1219		86
RES0701		33	RFA9165		184	RGL0015		65	RHD1221		86
RES0801		29	RFB0035		148	RGM0150		161	RHD1222		86

Ürün Kodu	Fiyat \$	Sayfa No	Ürün Kodu	Fiyat \$	Sayfa No	Ürün Kodu	Fiyat \$	Sayfa No	Ürün Kodu	Fiyat \$	Sayfa No
RHD1224		86	RHL1080		91	RHS0610		206	RKA1022		37
RHD1227		86	RHL1085		91	RHS0900		206	RKA1024		37
RHD1230		86	RHL1090		91	RHS1201		214	RKA1027		37
RHD3419		89	RHL1100		91	RHS1750		206	RKA1030		37
RHD3421		89	RHL1208		86	RHS2100		206	RKA1032		37
RHD3424		89	RHL1210		86	RHS2445		208	RKB0009		183
RHD3427		89	RHL1211		86	RHS3050		208	RKB0012		183
RHD3430		89	RHL1212		86	RHT0003		209	RKB0160		99
RHD3432		89	RHL1213		86	RHT0013		210	RKB0200		99
RHD3436		89	RHL1215		86	RHT0014		210	RKC0081		187
RHD3438		89	RHL1217		86	RHT0015		210	RKC0192		198
RHD3441		89	RHL1218		86	RHT0016		210	RKC0205		188
RHD3446		89	RHL1219		86	RHT0110		197	RKC0305		188
RHG4000		213	RHL1221		86	RHT5560		87	RKC0405		188
RHH1500		215	RHL1227		86	RHT8060		87	RKC0505		188
RHH5815		215	RHL1230		86	RHU0030		217	RKD0040		152
RHH5875		215	RHL1232		86	RHU1175		90	RKD0055		152
RHH8115		215	RHL3419		89	RHU1250		90	RKD0065		152
RHH8175		215	RHL3421		89	RHU2075		86	RKD0080		152
RHK0100		185	RHL3424		89	RHU2125		86	RKD0175		161
RHK0200		192	RHL3427		89	RHU3175		89	RKD7025		46
RHK1015		199	RHL3430		89	RHZ3004		212	RKD7027		46
RHK1217		199	RHL3432		89	RHZ8016		214	RKD7030		46
RHK2500		211	RHL3433		89	RKA0212		101	RKD7040		46
RHK5008		199	RHL3434		89	RKA0632		37	RKD7045		46
RHK6010		199	RHL3436		89	RKA0822		37	RKD7050		46
RHK8125		199	RHL3438		89	RKA1006		37	RKE0160		99
RHL1024		91	RHL3441		89	RKA1007		37	RKE0180		161
RHL1027		91	RHL3446		89	RKA1008		37	RKE0200		99
RHL1030		91	RHL3450		89	RKA1009		37	RKE1005		149
RHL1032		91	RHL3455		89	RKA1010		37	RKE1400		188
RHL1033		91	RHL3460		89	RKA1011		37	RKG1020		179
RHL1036		91	RHL3465		89	RKA1012		37	RKK0042		108
RHL1038		91	RHM0012		87	RKA1013		37	RKK0101		129
RHL1041		91	RHM0034		90	RKA1014		37	RKK0145		127
RHL1046		91	RHM0400		211	RKA1015		37	RKK0190		127
RHL1050		91	RHM1800		211	RKA1016		37	RKK0200		105
RHL1055		91	RHP2448		213	RKA1017		37	RKK0801		180
RHL1060		91	RHS0030		216	RKA1018		37	RKL3040		43
RHL1065		91	RHS0040		216	RKA1019		37	RKL3050		43
RHL1070		91	RHS0418		156	RKA1020		37	RKL3060		43
RHL1075		91	RHS0600		207	RKA1021		37	RKL3080		43

Ürün Kodu	Fiyat \$	Sayfa No	Ürün Kodu	Fiyat \$	Sayfa No	Ürün Kodu	Fiyat \$	Sayfa No	Ürün Kodu	Fiyat \$	Sayfa No
RKL3100		43	RLA3421		83	RLT5601		77	RMY2115		106
RKL3120		43	RLA3422		83	RLU0250		71	RMY3115		106
RKL3130		43	RLA3424		83	RMA0013		154	RMY4115		106
RKL3140		43	RLA3427		83	RMA0405		154	RMY5115		106
RKL3170		43	RLA3430		83	RMB0014		164	RMZ0133		164
RKL3190		43	RLA3432		83	RMB0110		156	RMZ0176		164
RKM0250		160	RLA3436		83	RMB0115		156	RMZ0610		164
RKM0255		160	RLA3438		83	RMB0120		156	RNZ0412		145
RKM250L		160	RLA3441		83	RMB0130		156	RNZ0512		145
RKM250R		160	RLA3446		83	RMB0900		164	ROK0960		180
RKM250S		160	RLA3450		83	RMB1210		154	ROT0101		176
RKP0160		98	RLA3455		83	RMB1800		164	ROT0102		177
RKP0180		98	RLA3460		83	RMK0150		169	ROT0103		177
RKP0200		98	RLS0030		197	RMK0200		108	ROT0104		177
RKP0230		185	RLS0120		196	RMK0734		168	ROT0105		177
RKP0645		104	RLS0310		196	RMK1115		107	ROT0106		176
RKP0650		104	RLS1040		197	RMK2115		107	ROT0107		176
RKP3049		185	RLT0014		82	RMK3115		107	ROT0108		176
RKP3050		185	RLT0015		82	RMK4115		107	ROT0109		177
RKS0029		108	RLT0901		80	RMK5115		106	ROT0110		176
RKS0062		108	RLT0902		80	RMK6115		107	ROT0111		177
RKS0062-1		108	RLT1001		61	RMK7115		106	ROT1005		44
RKS0062-2		108	RLT1006		79	RMK8115		106	ROT1006		44
RKS0062-3		108	RLT1012		79	RMK9115		107	ROT1008		44
RKS0160		99	RLT1205		124	RML0017		182	ROT1010		44
RKS0165		109	RLT1206		124	RMM0025		169	ROT1012		44
RKS0300		160	RLT1207		124	RMM0066		168	ROT1014		44
RKT0215		184	RLT1211		124	RMM2550		169	ROT5000		54
RKT2060		80	RLT1213		124	RMM5000		168	RPA3000		168
RKT6025		45	RLT1501		78	RMM6000		168	RPC0022		174
RKT6027		45	RLT1502		76	RMS1200		198	RPC0030		186
RKT6030		45	RLT1601		78	RMS1400		198	RPC0040		186
RKT6040		45	RLT1604		61	RMS1616		154	RPC0060		186
RKT6045		45	RLT1801		76	RMS1618		154	RPH1025		59
RKT6050		45	RLT1901		81	RMS2011		180	RPH2025		59
RKY0160		99	RLT2402		65	RMS2012		180	RPH3025		59
RKZ0210		146	RLT2501		77	RMT0100		204	RPK3000		193
RKZ0312		145	RLT2502		76	RMT0125		204	RPM1312		153
RKZ0412		145	RLT2503		77	RMT1115		105	RPP0500		109
RKZ0512		145	RLT2504		78	RMU0615		105	RPP2450		109
RKZ0612		145	RLT4002		61	RMV2000		194	RPS0208		146
RLA3419		83	RLT4501		61	RMY1115		106	RPY0300		196

Ürün Kodu	Fiyat \$	Sayfa No	Ürün Kodu	Fiyat \$	Sayfa No	Ürün Kodu	Fiyat \$	Sayfa No	Ürün Kodu	Fiyat \$	Sayfa No
RPY0500		196	RSA0030		174	RSM1226		151	RSP0925		103
RPY0750		196	RSA0050		175	RSM1434		151	RSP1011		150
RPZ0215		145	RSA0053		172	RSM1634		151	RSP1016		150
RPZ0315		145	RSA0078		173	RSM1654		151	RSP1021		150
RPZ0415		145	RSA0079		173	RSM1840		152	RSP1026		150
RPZ0515		145	RSA0080		174	RSM1854		151	RSP1035		150
RPZ0615		145	RSA0089		172	RSM2034		151	RSP1121		150
RPZ0815		145	RSA0090		172	RSM2052		151	RSP1216		150
RRA0810		42	RSA0091		172	RSM2234		151	RSP1221		150
RRA0911		42	RSD5100		118	RSM2252		151	RSP1226		150
RRA1012		42	RSD5125		118	RSM2434		151	RSP1316		150
RRA1113		42	RSD5150		118	RSM2452		151	RSP1416		150
RRA1214		42	RSD5200		118	RSM2534		151	RSP1426		150
RRA1314		42	RSD5300		118	RSM2837		151	RSP1435		150
RRA1517		42	RSD6045		121	RSM2857		151	RSP1445		150
RRA1719		42	RSD6100		118	RSM3037		151	RSP1460		150
RRA1922		42	RSD6125		118	RSM3237		151	RSP1616		150
RRA2224		42	RSD6150		118	RSM3257		151	RSP1645		150
RRC0136		181	RSD8200		118	RSP0133		186	RSP1826		150
RRC0137		181	RSK0250		152	RSP0510		103	RSP1835		150
RRC0138		181	RSK1200		194	RSP0515		103	RSP1845		150
RRC0160		181	RSK1840		152	RSP0516		150	RSP1860		150
RRC0180		181	RSK3075		118	RSP0520		103	RSP2245		150
RRC0190		181	RSK3100		118	RSP0525		103	RSP2435		150
RRC0290		181	RSK3125		118	RSP0611		150	RSP2445		150
RRC0400		181	RSK4100		118	RSP0710		103	RSP2645		150
RRC0460		181	RSK4125		118	RSP0711		150	RSP2845		150
RRC1210		204	RSK5100		118	RSP0715		103	RSP5503		102
RRC3075		204	RSK5125		118	RSP0716		150	RSP5504		102
RRC4100		204	RSK5150		118	RSP0720		103	RSP6521		150
RRC5125		204	RSL1005		120	RSP0721		150	RSP9001		102
RRC7175		204	RSL1006		120	RSP0725		103	RSP9002		102
RRC9225		204	RSL1007		120	RSP0726		150	RSP9003		102
RRK0250		182	RSL1008		120	RSP0816		150	RSP9004		102
RRK0400		182	RSL1009		120	RSP0821		150	RSS0280		198
RRS1020		188	RSL1010		120	RSP0826		150	RSS1301		81
RRT0119		178	RSL1011		120	RSP0845		150	RSS6000		122
RRT0120		178	RSL1012		120	RSP0910		103	RSS6500		123
RRT7000		54	RSL1013		120	RSP0915		103	RSS7000		122
RSA0010		173	RSL1019		198	RSP0916		150	RST0010		120
RSA0012		173	RSL5000		123	RSP0920		103	RST0015		120
RSA0022		174	RSM0250		152	RSP0921		150	RST0020		120

Ürün Kodu	Fiyat \$	Sayfa No	Ürün Kodu	Fiyat \$	Sayfa No	Ürün Kodu	Fiyat \$	Sayfa No	Ürün Kodu	Fiyat \$	Sayfa No
RST0025		120	RTA0050		59	RTB1040		43	RTD1405		57
RST0027		120	RTA0060		59	RTB1080		43	RTD1406		57
RST0030		120	RTA0070		59	RTB1100		43	RTD1407		57
RST0106		129	RTA0600		51	RTB2000		51	RTD1408		57
RST0665		142	RTA0602		51	RTB2020		50	RTD1410		57
RST0765		142	RTA0603		51	RTB2025		50	RTD1411		57
RST1010		120	RTA0900		15	RTB2030		50	RTF0053		201
RST1015		120	RTA1010		14	RTB2040		50	RTF0086		201
RST1020		120	RTA1020		14	RTB2050		50	RTK0001		94
RST1025		120	RTA1030		14	RTB2060		50	RTK0155		85
RST1027		120	RTA1040		15	RTB2080		50	RTK0160		108
RST1030		120	RTA1060		16	RTB5040		44	RTK0180		108
RST1065		142	RTA1234		95	RTB5050		44	RTK0225		94
RST1165		142	RTA3050		21	RTB5060		44	RTK0407		75
RST1365		142	RTA3060		21	RTB5080		44	RTK0411		75
RST6000		123	RTA3070		22	RTB5100		44	RTK0412		75
RSU0020		217	RTA3080		23	RTC0100		144	RTK0712		146
RSY3080		119	RTA3090		23	RTC0200		144	RTK1010		94
RSY3100		119	RTA5001		17	RTC0300		144	RTK1210		146
RSY3125		119	RTA5020		53	RTC0500		144	RTK1225		71
RSY4100		119	RTA5025		53	RTC1000		144	RTK1235		71
RSY4125		119	RTA5030		53	RTC1500		144	RTK1415		58
RSY5045		121	RTA5060		53	RTC2000		144	RTK1612		146
RSY5100		119	RTA5080		53	RTD0208		70	RTK2020		94
RSY5125		119	RTA5141		26	RTD0210		70	RTK2513		94
RSY5150		119	RTA6001		18	RTD0212		70	RTK3445		82
RSY5200		119	RTA6009		53	RTD0214		70	RTK3475		95
RSY5300		119	RTA6010		53	RTD0216		70	RTK3820		64
RSY6045		121	RTA6027		53	RTD0218		70	RTK5022		94
RSY6100		119	RTA6205		27	RTD0220		70	RTK6030		94
RSY6125		119	RTA7001		19	RTD0222		70	RTK7033		94
RSY6150		119	RTA7009		53	RTD0224		70	RTL0014		59
RSY8150		119	RTA7010		53	RTD1208		70	RTL0108		68
RSZ3060		122	RTA7015		53	RTD1210		70	RTL0109		68
RSZ5045		121	RTA7025		53	RTD1212		70	RTL0110		68
RSZ5080		122	RTA7027		53	RTD1214		70	RTL0111		68
RSZ6045		121	RTA7040		53	RTD1216		70	RTL0112		68
RSZ6100		122	RTA8001		20	RTD1218		70	RTL0113		68
RSZ6150		122	RTA9001		24	RTD1220		70	RTL0114		68
RTA0010		59	RTA9101		24	RTD1222		70	RTL0115		68
RTA0030		59	RTA9201		25	RTD1224		70	RTL0116		68
RTA0040		59	RTA9301		25	RTD1404		57	RTL0117		68

Ürün Kodu	Fiyat \$	Sayfa No	Ürün Kodu	Fiyat \$	Sayfa No	Ürün Kodu	Fiyat \$	Sayfa No	Ürün Kodu	Fiyat \$	Sayfa No
RTL0118		68	RTL0530		72	RTL1214		68	RTL5040		72
RTL0119		68	RTL0535		72	RTL1215		68	RTL5045		72
RTL0120		68	RTL0540		72	RTL1216		68	RTL5050		72
RTL0121		68	RTL0545		72	RTL1217		68	RTL5055		72
RTL0122		68	RTL0550		72	RTL1218		68	RTL5060		72
RTL0123		68	RTL0555		72	RTL1219		68	RTL5070		72
RTL0124		68	RTL0560		72	RTL1220		68	RTL5516		73
RTL0125		68	RTL0570		72	RTL1221		68	RTM0250		160
RTL0126		68	RTL0605		73	RTL1222		68	RTO1250		95
RTL0127		68	RTL0606		73	RTL1224		68	RTO1255		95
RTL0128		68	RTL0607		73	RTL1227		68	RTP0068		109
RTL0129		68	RTL0608		73	RTL1230		68	RTP0068P		109
RTL0130		68	RTL0609		73	RTL1232		68	RTP0069		109
RTL0132		68	RTL0610		73	RTL3806		63	RTS0060		135
RTL0204		57	RTL0614		73	RTL3807		63	RTS0080		135
RTL0205		57	RTL0616		73	RTL3808		63	RTS0141		79
RTL0206		57	RTL0704		60	RTL3809		63	RTS0604		125
RTL0207		57	RTL0708		73	RTL3810		63	RTS0701		81
RTL0208		57	RTL0710		73	RTL3811		63	RTS0702		60
RTL0209		57	RTL0712		73	RTL3812		63	RTS0703		74
RTL0210		57	RTL0714		73	RTL3813		63	RTS1006		52
RTL0211		57	RTL0716		73	RTL3814		63	RTS1007		52
RTL0212		57	RTL0718		73	RTL3815		63	RTS1011		52
RTL0213		57	RTL0910		59	RTL3816		63	RTS1012		52
RTL0308		63	RTL0920		59	RTL3817		63	RTS1013		52
RTL0310		63	RTL0925		59	RTL3818		63	RTS1301		81
RTL0311		63	RTL0927		59	RTL3819		63	RTS2560		88
RTL0312		63	RTL0930		59	RTL3820		63	RTT7000		54
RTL0313		63	RTL0940		59	RTL3821		63	RTX0010		125
RTL0404		57	RTL0T10		59	RTL3822		63	RTX0015		125
RTL0405		57	RTL0T15		59	RTL3824		63	RTX0025		125
RTL0406		57	RTL0T20		59	RTL5008		73	RTX0027		125
RTL0407		57	RTL0T27		59	RTL5010		73	RTX0030		125
RTL0408		57	RTL0T30		59	RTL5012		73	RTX0040		125
RTL0409		57	RTL0T40		59	RTL5014		73	RTX1007		124
RTL0410		57	RTL1016		73	RTL5016		73	RTX1010		124
RTL0411		57	RTL1040		60	RTL5018		73	RTX1015		124
RTL0412		57	RTL1208		68	RTL5020		72	RTX1020		124
RTL0413		57	RTL1210		68	RTL5025		72	RTX1027		124
RTL0520		72	RTL1211		68	RTL5027		72	RTX1040		124
RTL0525		72	RTL1212		68	RTL5030		72	RTX1530		125
RTL0527		72	RTL1213		68	RTL5035		72	RTX6000		128



www.retta.com.tr

RETTA PROFESYONEL EL ALETLERİ A.Ş.

Orhangazi Mah. 1673. Sk. No: 18/4 Esenyurt - İSTANBUL
Tel: + 90 212 801 02 01 - www.retta.com.tr - retta@retta.com.tr